



---

Volume 29 (1999)

Pennsylvania Bulletin  
Repository

---

7-3-1999

## July 3, 1999 (Pages 3337-3608)

Pennsylvania Legislative Reference Bureau

Follow this and additional works at: [https://digitalcommons.law.villanova.edu/pabulletin\\_1999](https://digitalcommons.law.villanova.edu/pabulletin_1999)

---

### Recommended Citation

Pennsylvania Legislative Reference Bureau, "July 3, 1999 (Pages 3337-3608)" (1999). *Volume 29 (1999)*. 27.

[https://digitalcommons.law.villanova.edu/pabulletin\\_1999/27](https://digitalcommons.law.villanova.edu/pabulletin_1999/27)

This July is brought to you for free and open access by the Pennsylvania Bulletin Repository at Villanova University Charles Widger School of Law Digital Repository. It has been accepted for inclusion in Volume 29 (1999) by an authorized administrator of Villanova University Charles Widger School of Law Digital Repository.

# PENNSYLVANIA BULLETIN

Volume 29

Number 27

Saturday, July 3, 1999 • Harrisburg, Pa.

Pages 3337—3608

See Part II page 3513 for the  
Department of Public Welfare's  
Protective Services

See Part III page 3567 for the  
Subject Index for January—June 1999

## **Part I**

### **Agencies in this issue:**

The General Assembly  
The Courts  
Department of Banking  
Department of Education  
Department of Environmental Protection  
Department of General Services  
Department of Health  
Department of Public Welfare  
Department of Revenue  
Department of Transportation  
Fish and Boat Commission  
Governor's Office  
Health Care Cost Containment Council  
Independent Regulatory Review Commission  
Insurance Department  
Pennsylvania Public Utility Commission  
Philadelphia Regional Port Authority  
Turnpike Commission

**Detailed list of contents appears inside.**

**Latest Pennsylvania Code Reporter  
(Master Transmittal Sheet):**

**No. 296, July 1999**

---

**PENNSYLVANIA**



**BULLETIN**

(ISSN 0162-2137)

published weekly by Fry Communications, Inc. for the Commonwealth of Pennsylvania, Legislative Reference Bureau, 647 Main Capitol Building, State & Third Streets, Harrisburg, Pa. 17120, under the policy supervision and direction of the Joint Committee on Documents pursuant to Part II of Title 45 of the Pennsylvania Consolidated Statutes (relating to publication and effectiveness of Commonwealth Documents). Subscription rate \$82.00 per year, postpaid to points in the United States. Individual copies \$2.50. Checks for subscriptions and individual copies should be made payable to "Fry Communications, Inc." Periodicals postage paid at Harrisburg, Pennsylvania.

Postmaster send address changes to:

FRY COMMUNICATIONS  
Attn: *Pennsylvania Bulletin*  
800 W. Church Rd.  
Mechanicsburg, Pennsylvania 17055-3198  
(717) 766-0211 ext. 2340  
(800) 334-1429 ext. 2340 (toll free, out-of-State)  
(800) 524-3232 ext. 2340 (toll free, in State)

Orders for subscriptions and other circulation matters should be sent to:

Fry Communications, Inc.  
Attn: *Pennsylvania Bulletin*  
800 W. Church Rd.  
Mechanicsburg, PA 17055-3198

Copyright © 1999 Commonwealth of Pennsylvania  
ISBN 0-8182-0004-9

Editorial preparation, composition, printing and distribution of the *Pennsylvania Bulletin* is effected on behalf of the Commonwealth of Pennsylvania by FRY COMMUNICATIONS, Inc., 800 W. Church Road, Mechanicsburg, Pennsylvania 17055-3198.

# Contents

## THE GENERAL ASSEMBLY

Recent actions during the 1999 regular session of the General Assembly . . . . . 3346

## THE COURTS

### LOCAL COURT RULES

#### Schuylkill County

Amendment of Rule of Judicial Administration 1901(b)(1)(a) . . . . . 3348

## EXECUTIVE AGENCIES

### DEPARTMENT OF BANKING

#### Notices

Action on applications . . . . . 3373

### DEPARTMENT OF EDUCATION

#### Proposed Rulemaking

Institutional preparation of professional educators . . 3363

### DEPARTMENT OF ENVIRONMENTAL PROTECTION

#### Notices

Applications, actions and special notices . . . . . 3375  
 Availability of final general plan approval and general operating permit for nonheatset web offset lithographic printing presses (BAQ-GPA/GP-10) . . . . . 3406  
 Small Water Systems Technical Assistance Center Advisory Board; special committee meeting . . . . . 3412  
 State Board for Certification of Sewage Treatment Plant and Waterworks Operators; special committee meeting . . . . . 3412  
 Wetlands Protection Advisory Committee; cancellation of meeting . . . . . 3413

Small Water Systems Technical Assistance Center Advisory Board; special committee meeting . . . . . 3412  
 State Board for Certification of Sewage Treatment Plant and Waterworks Operators; special committee meeting . . . . . 3412  
 Wetlands Protection Advisory Committee; cancellation of meeting . . . . . 3413

### DEPARTMENT OF GENERAL SERVICES

#### Notices

Contract awards . . . . . 3509  
 State contracts information . . . . . 3501

### DEPARTMENT OF HEALTH

#### Notices

Human Immunodeficiency Virus (HIV) Community Prevention Planning Committee; public meetings . . . . . 3413  
 Laboratories approved to determine blood alcohol content under the Clinical Laboratory Act, the Vehicle Code, the Fish and Boat Code and the Game and Wildlife Code . . . . . 3413

### DEPARTMENT OF PUBLIC WELFARE

#### Rules and Regulations

Protective services (Part II) . . . . . 3513

### DEPARTMENT OF REVENUE

#### Notices

Pennsylvania Bingo Doubler instant lottery game . . . 3420

### DEPARTMENT OF TRANSPORTATION

#### Notices

Multijurisdictional permit agreement . . . . . 3422  
 Notice to all consultants; anticipated consultants solicitations . . . . . 3439  
 Retention of engineering firms . . . . . 3442

### FISH AND BOAT COMMISSION

#### Rules and Regulations

Age of operator . . . . . 3362

#### Proposed Rulemaking

Lake Erie fishing permit . . . . . 3369  
 Special regulations counties and boats carrying passengers for hire . . . . . 3370

### GOVERNOR'S OFFICE

#### Notices

Regulatory review . . . . . 3443

### HEALTH CARE COST CONTAINMENT COUNCIL

#### Notices

Meeting dates . . . . . 3492

### INDEPENDENT REGULATORY REVIEW COMMISSION

#### Rules and Regulations

Practice and procedure . . . . . 3349

#### Notices

Actions taken by the Commission . . . . . 3492

### INSURANCE DEPARTMENT

#### Notices

Application for approval to acquire control of Calvert Insurance Company . . . . . 3495  
 Coal Mine Compensation Rating Bureau of Pennsylvania; Workers' Compensation employer assessment procedures filing . . . . . 3495  
 Liberty Mutual Fire Insurance Company; homeowners rate filing . . . . . 3495  
 Review procedure hearings; cancellation or refusal of insurance . . . . . 3495  
 Review procedure hearings under the Unfair Insurance Practices Act . . . . . 3496  
 State Farm Fire and Casualty Company; private passenger automobile rate and rule revision . . . . . 3496

### PENNSYLVANIA PUBLIC UTILITY COMMISSION

#### Notices

Consolidated Rail Corporation—railroad . . . . . 3497  
 PFG Gas, Inc.—gas service . . . . . 3497  
 Service of notice of motor carrier applications . . . . . 3497  
 The Preston Drainage Company—sewer service . . . . . 3497

### PHILADELPHIA REGIONAL PORT AUTHORITY

#### Notices

Request for proposals . . . . . 3498

### TURNPIKE COMMISSION

#### Notices

Retention of an engineering firm (2 documents) . . . . . 3498, 3499

---

**Now Available Online at <http://www.pabulletin.com>**

---

# READER'S GUIDE TO THE PENNSYLVANIA BULLETIN AND PENNSYLVANIA CODE

## ***Pennsylvania Bulletin***

The *Pennsylvania Bulletin* is the official gazette of the Commonwealth of Pennsylvania. It is published every week and includes a table of contents. A cumulative subject matter index is published quarterly.

The *Pennsylvania Bulletin* serves several purposes. First, it is the temporary supplement to the *Pennsylvania Code*, which is the official codification of agency rules and regulations and other statutorily authorized documents. Changes in the codified text, whether by adoption, amendment, repeal or emergency action must be published in the *Pennsylvania Bulletin*. Further, agencies proposing changes to the codified text do so in the *Pennsylvania Bulletin*.

Second, the *Pennsylvania Bulletin* also publishes: Governor's Executive Orders; State Contract Notices; Summaries of Enacted Statutes; Statewide and Local Court Rules; Attorney General Opinions; Motor Carrier Applications before the Public Utility Commission; Applications and Actions before the Department of Environmental Protection; Orders of the Independent Regulatory Review Commission; and other documents authorized by law.

The text of certain documents published in the *Pennsylvania Bulletin* is the only valid and enforceable text. Courts are required to take judicial notice of the *Pennsylvania Bulletin*.

## **Adoption, Amendment or Repeal of Regulations**

Generally an agency wishing to adopt, amend or repeal regulations must first publish in the *Pennsylvania Bulletin* a Notice of Proposed Rulemaking. There are limited instances where the agency may omit the proposal step; they still must publish the adopted version.

The Notice of Proposed Rulemaking contains the full text of the change, the agency contact person, a fiscal note required by law and background for the action.

The agency then allows sufficient time for public comment before taking final action. An adopted proposal must be published in the *Pennsylvania*

*Bulletin* before it can take effect. If the agency wishes to adopt changes to the Notice of Proposed Rulemaking to enlarge the scope, they must re-propose.

## **Citation to the *Pennsylvania Bulletin***

Cite material in the *Pennsylvania Bulletin* by volume number and page number. Example: Volume 1, *Pennsylvania Bulletin*, page 801 (short form: 1 Pa.B. 801).

## ***Pennsylvania Code***

The *Pennsylvania Code* is the official codification of rules and regulations issued by Commonwealth agencies and other statutorily authorized documents. The *Pennsylvania Bulletin* is the temporary supplement to the *Pennsylvania Code*, printing changes as soon as they occur. These changes are then permanently codified by the *Pennsylvania Code Reporter*, a monthly, loose-leaf supplement.

The *Pennsylvania Code* is cited by title number and section number. Example: Title 10 *Pennsylvania Code*, § 1.1 (short form: 10 Pa.Code § 1.1).

Under the *Pennsylvania Code* codification system, each regulation is assigned a unique number by title and section. Titles roughly parallel the organization of Commonwealth government. Title 1 *Pennsylvania Code* lists every agency and its corresponding *Code* title location.

## **How to Find Documents**

Search for your area of interest in the *Pennsylvania Code*.

The *Pennsylvania Code* contains, as Finding Aids, subject indexes for the complete *Code* and for each individual title, a list of Statutes Used As Authority for Adopting Rules and a list of annotated cases. Source Notes give you the history of the documents. To see if there have been recent changes, not yet codified, check the List of *Pennsylvania Code* Chapters Affected in the most recent issue of the *Pennsylvania Bulletin*.

The *Pennsylvania Bulletin* also publishes a quarterly List of Pennsylvania Code Sections Affected which lists the regulations in numerical order, followed by the citation to the *Pennsylvania Bulletin* in which the change occurred.

**SUBSCRIPTION INFORMATION: (717) 766-0211  
GENERAL INFORMATION AND FINDING AIDS: (717) 783-1530**

### Printing Format

Material proposed to be added to an existing rule or regulation is printed in **bold face** and material proposed to be deleted from such a rule or regulation is enclosed in brackets [ ] and printed in **bold face**. Asterisks indicate ellipsis of *Pennsylvania Code* text retained without change. Proposed new or additional regulations are printed in ordinary style face.

### Fiscal Notes

Section 612 of The Administrative Code of 1929 (71 P. S. § 232) requires that the Office of Budget prepare a fiscal note for regulatory actions and administrative procedures of the administrative departments, boards, commissions or authorities receiving money from the State Treasury stating whether the proposed action or procedure causes a loss of revenue or an increase in the cost of programs for the Commonwealth or its political subdivisions; that the fiscal note be published in the *Pennsylvania Bulletin* at the same time as the proposed change is advertised; and that the fiscal note shall provide the following information: (1) the designation of the fund out of which the appropriation providing for expenditures under the action or procedure shall be made; (2) the probable cost for the fiscal year the program is implemented; (3) projected cost estimate of the program for each of the five succeeding fiscal years; (4) fiscal history of the program for which expenditures are to be made; (5) probable loss of revenue for the fiscal year of its implementation; (6) projected loss of revenue from the program for each of the five succeeding fiscal years; (7) line item, if any, of the General Appropriation Act or other appropriation act out of which expenditures or losses of Commonwealth funds shall occur as a result of the action or procedures; (8) recommendation, if any, of the Secretary of the Budget and the reasons therefor.

The required information is published in the foregoing order immediately following the proposed change to which it relates; the omission of an item indicates that the agency text of the fiscal note states that there is no information available with respect thereto. In items (3) and (6) information is set forth for the first through fifth fiscal years; in that order, following the year the program is implemented, which is stated. In item (4) information is set forth for the current and two immediately preceding years, in that order. In item (8) the recommendation, if any, made by the Secretary of Budget is published with the fiscal note. See 4 Pa. Code § 7.231 *et seq.* Where "no fiscal impact" is published, the statement means no additional cost or revenue loss to the Commonwealth or its local political subdivision is intended.

### Reproduction, Dissemination or Publication of Information

Third parties may not take information from the *Pennsylvania Code* and *Pennsylvania Bulletin* and reproduce, disseminate or publish such information except as provided by 1 Pa. Code § 3.44. 1 Pa. Code § 3.44 reads as follows:

#### § 3.44. General permission to reproduce content of Code and Bulletin.

Information published under this part, which information includes, but is not limited to, cross references, tables of cases, notes of decisions, tables of contents, indexes, source notes, authority notes, numerical lists and codification guides, other than the actual text of rules or regulations may be reproduced only with the written consent of the Bureau. The information which appears on the same leaf with the text of a rule or regulation, however, may be incidentally reproduced in connection with the reproduction of the rule or regulation, if the reproduction is for the private use of a subscriber and not for resale. There are no other restrictions on the reproduction of information published under this part, and the Commonwealth hereby consents to a reproduction.

## List of Pa. Code Chapters Affected

The following numerical guide is a list of the chapters of each title of the *Pennsylvania Code* affected by documents published in the *Pennsylvania Bulletin* during 1999.

### 1 Pa. Code (General Provisions)

#### Adopted Rules

101	3349
201	3349
301	3349
303	3349
305	3349
307	3349
309	3349
311	3349
313	3349
315	3349

#### Proposed Rulemaking

101	980
201	980
301	980
303	980
305	980
307	980
309	980
311	980
313	980
315	980

### 4 Pa. Code (Administration)

#### Adopted Rules

5	2570, 2762
6	2572
7	806, 3066
116	3201
117	3205

#### Proposed Rulemaking

120b	1719
120c	1721
120d	1717

#### Statements of Policy

9	207, 457, 574, 1230, 2034, 2302, 2681, 3216
---	---

### 7 Pa. Code (Agriculture)

#### Proposed Rulemaking

130c	1496
130d	1496
151	3215

#### Statements of Policy

137a	3072
------	------

### 10 Pa. Code (Banks and Banking)

#### Statements of Policy

21	3000
----	------

### 12 Pa. Code (Community and Economic Development)

#### Proposed Statements of Policy

31	1725
----	------

#### Statements of Policy

31	2859
----	------

### 22 Pa. Code (Education)

#### Adopted Rules

3	399
4	399

5	399
6	399

#### Proposed Rulemaking

354	3363
-----	------

### 25 Pa. Code (Environmental Protection)

#### Adopted Rules

109	2231
121	1879
129	1879, 1889
260	2367
260a (with correction)	2367, 2576
261	2367
261a	2367
262	2367
262a	2367
263	2367
263a	2367
264	2367
264a	2367
265	2367
265a	2367
266	2367
266a	2367
266b	2367
267	2367
268a	2367
269	2367
269a	2367
270	2367
270a	2367

#### Proposed Rulemaking

72	979
86	548
91	2145
92	455
93	455
95	455
97	2145
101	2145
121	1214, 1299
123	1214, 1319
129	1299
139	1299
145	1319
261	1975
266	1975
287	1975
298	1975
901	647
1021	1074, 1214, 1612

### 28 Pa. Code (Health and Safety)

#### Proposed Rulemaking

4	2671
18	820
911	332
912	332
1001	903
1003	903
1005	903
1007	903

1009 ..... 903  
 1011 ..... 903  
 1013 ..... 903  
 1015 ..... 903

**31 Pa. Code (Insurance)  
 Adopted Rules**

84 ..... 3208  
 89 ..... 172  
 125 ..... 3209

**Proposed Rulemaking**

62 ..... 655  
 89 ..... 650

**Statements of Policy**

38 ..... 3085

**34 Pa. Code (Labor & Industry)**

**Adopted Rules**

121 ..... 2649

**Proposed Rulemaking**

123 ..... 3161  
 125 ..... 3161  
 129 ..... 3161

**37 Pa. Code (Law)**

**Proposed Rulemaking**

93 ..... 1513  
 95 ..... 1504

**49 Pa. Code (Professional and Vocational Standards)**

**Adopted Rules**

5 ..... 2294  
 15 ..... 2295  
 31 ..... 1392  
 36 ..... 1393, 1610  
 37 ..... 2857  
 41 ..... 2296

**Proposed Rulemaking**

11 ..... 1613  
 21 ..... 2299  
 23 ..... 2300  
 25 ..... 1613  
 27 ..... 1088  
 31 ..... 1897  
 33 ..... 1895  
 35 ..... 565  
 37 ..... 1897  
 39 ..... 662, 2582  
 40 ..... 1615  
 41 ..... 2145  
 42 ..... 1896, 3070  
 47 ..... 1897

**Statements of Policy**

39 ..... 1617

**51 Pa. Code (Public Officers)**

**Proposed Rulemaking**

31 ..... 548  
 33 ..... 548  
 35 ..... 548  
 37 ..... 548  
 39 ..... 548  
 41 ..... 548  
 43 ..... 548  
 45 ..... 548

**52 Pa. Code (Public Utilities)**

**Adopted Rules**

57 ..... 2667  
 59 ..... 2667

**Proposed Rulemaking**

57 ..... 2025  
 59 ..... 1515  
 64 ..... 2779  
 Unclassified ..... 1895

**Statements of Policy**

69 ..... 2034, 2147, 2495

**Proposed Statements of Policy**

41 ..... 1617  
 69 ..... 1617

**55 Pa. Code (Public Welfare)**

**Adopted Rules**

165 ..... 271  
 168 ..... 271  
 183 ..... 271  
 3040 ..... 271  
 3130 ..... 3295  
 3480 ..... 3513  
 3490 ..... 3513  
 3680 ..... 3295  
 3710 ..... 3295  
 3800 ..... 3295  
 3810 ..... 3295  
 5310 ..... 3295  
 6400 ..... 3295

**Statements of Policy**

1187 ..... 3218

**58 Pa. Code (Recreation)**

**Adopted Rules**

51 ..... 3210  
 53 ..... 1068  
 61 ..... 819  
 63 ..... 2298, 3211, 3212  
 65 ..... 1069, 3210, 3212  
 75 ..... 819, 3210  
 91 (correction) ..... 3213, 3362  
 93 ..... 1068  
 109 ..... 1068  
 111 ..... 1070, 3210  
 133 ..... 1071  
 139 (with correction) ..... 2454, 2576, 2999  
 141 ..... 2458  
 143 (with correction) ..... 2458, 2577  
 145 ..... 1071  
 147 ..... 1071, 1072

**Proposed Rulemaking**

51 ..... 1224  
 61 ..... 1085  
 63 ..... 205, 822, 823, 1397  
 65 ..... 823, 1224  
 69 ..... 3369  
 75 ..... 1087, 1515  
 99 ..... 2680  
 111 ..... 1224, 3370  
 115 ..... 3370  
 117 ..... 2678  
 131 ..... 2578  
 135 ..... 2578, 2581



139 ..... 1225, 1397  
 141 ..... 1398, 2580  
 143 ..... 1398

**61 Pa. Code (Revenue)  
 Statements of Policy**

94 ..... 2037  
 125 ..... 2037

**64 Pa. Code (Securities)  
 Adopted Rules**

202 (with correction) ..... 202, 547  
 206 (with correction) ..... 202, 547  
 302 (with correction) ..... 202, 547  
 606 (with correction) ..... 202, 547  
 609 (with correction) ..... 202, 547  
 610 (with correction) ..... 202, 547

**67 Pa. Code (Transportation)  
 Adopted Rules**

175 ..... 2460, 2577

**Proposed Rulemaking**

173 ..... 1612  
 175 ..... 1612

**70 Pa. Code (Weights, Measures and Standard)**

1 ..... 2460  
 2 ..... 2460  
 3 ..... 2460  
 4 ..... 2460  
 5 ..... 2460  
 6 ..... 2460  
 7 ..... 2460  
 8 ..... 2460  
 9 ..... 2460  
 10 ..... 2460  
 21 ..... 2460  
 35 ..... 2460

**Statement of Policy**

39 ..... 2460

**201 Pa. Code (Rules of Judicial Administration)  
 Adopted Rules**

5 ..... 3189  
 7 ..... 2766  
 50 ..... 1709

**204 Pa. Code (Judicial System General Provisions)  
 Adopted Rules**

71 ..... 2143, 2855  
 82 ..... 809  
 91 ..... 2021  
 215 ..... 977

**Proposed Rulemaking**

83 ..... 2663

**207 Pa. Code (Judicial Conduct)  
 Adopted Rules**

5 ..... 1487  
 21 ..... 645

**210 Pa. Code (Appellate Procedure)  
 Adopted Rules**

21 ..... 544  
 35 ..... 544  
 39 ..... 1487  
 67 ..... 1360

**Proposed Rulemaking**

3 ..... 1709, 2766  
 5 ..... 2441  
 9 ..... 2441  
 15 ..... 2441  
 21 (with correction) ..... 2441, 2767

**225 Pa. Code (Rules of Evidence)  
 Adopted Rules**

Unclassified ..... 1712

**Proposed Rulemaking**

Article I ..... 2262  
 Article IV ..... 2263  
 Article VI ..... 2262, 2264  
 Article VIII ..... 2265

**231 Pa. Code (Rules of Civil Procedure)  
 Adopted Rules**

100 ..... 2266, 2767  
 200 ..... 449, 2266, 2767, 3189  
 400 ..... 2767, 3189, 3191  
 1000 ..... 2266, 2767, 3191  
 1300 ..... 2266, 3191  
 1500 ..... 2274  
 1600 ..... 2274  
 1650 ..... 2274  
 1700 ..... 2274  
 1910 (with correction) ..... 16, 645, 2767, 3191  
 1930 ..... 2767  
 2000 ..... 2274  
 2020 ..... 2274  
 2054 ..... 2767  
 2120 ..... 2274  
 2200 ..... 2274  
 2220 ..... 2274  
 2250 ..... 2274  
 2300 ..... 2274, 3191  
 2320 ..... 2274  
 2350 ..... 2274  
 2950 ..... 2767, 3191  
 2970 ..... 1715, 2767, 3191  
 2980 ..... 2274  
 3000 ..... 2281, 2767, 3191  
 4000 ..... 1715, 2281, 2767  
 Part II ..... 327, 329, 1494

**Proposed Rulemaking**

200 ..... 15, 168, 169  
 400 ..... 169  
 1910 ..... 1487  
 Part II ..... 1709, 2766

**234 Pa. Code (Rules of Criminal Procedure)  
 Adopted Rules**

50 ..... 2774, 2776  
 350 ..... 3069  
 1100 ..... 2289, 2777

**Proposed Rulemaking**

1 ..... 1360  
 2 ..... 1360  
 3 ..... 1360  
 4 ..... 1360  
 5 ..... 1360  
 6 ..... 1360  
 7 ..... 1360  
 8 ..... 1360  
 9 ..... 1360  
 10 ..... 1360  
 11 ..... 1360

20 .....	1360, 2664
30 .....	1360
50 .....	1360, 1385, 2770
100 .....	1360, 2444
200 .....	1360, 2444
300 .....	1360, 2444
1100 .....	1360, 2444
1400 .....	1360
1500 .....	1360
1600 .....	1360
1700 .....	1360
2000 .....	1360
4000 .....	1360
6000 .....	1360, 2444
9000 .....	1360

**246 Pa. Code (Minor Court Civil Rules)****Adopted Rules**

100 .....	3198
300 .....	3198

**249 Pa. Code (Philadelphia Rules)**

Unclassified .....	544, 545, 2964
--------------------	----------------

**252 Pa. Code (Allegheny County Rules)**

Unclassified .....	17, 1387
--------------------	----------

**255 Pa. Code (Local Court Rules)**

Unclassified .....	19, 24, 171, 330, 449, 453, 454, 809, 977, 978, 1067, 1388, 1389, 1390, 1495, 1853, 1873, 2143, 2575, 2855, 2995, 2996, 2997, 3069, 3199, 3348
--------------------	---

# PENNSYLVANIA BULLETIN

Volume 29

Number 27

Saturday, July 3, 1999 • Harrisburg, Pa.

## **Part II**

This part contains the  
Department of Public Welfare's  
Protective Services

---

**PENNSYLVANIA**



**BULLETIN**

(ISSN 0162-2137)

published weekly by Fry Communications, Inc. for the Commonwealth of Pennsylvania, Legislative Reference Bureau, 647 Main Capitol Building, State & Third Streets, Harrisburg, Pa. 17120, under the policy supervision and direction of the Joint Committee on Documents pursuant to Part II of Title 45 of the Pennsylvania Consolidated Statutes (relating to publication and effectiveness of Commonwealth Documents). Subscription rate \$82.00 per year, postpaid to points in the United States. Individual copies \$2.50. Checks for subscriptions and individual copies should be made payable to "Fry Communications, Inc." Second class postage paid at Harrisburg, Pennsylvania.

Postmaster send address changes to:

FRY COMMUNICATIONS  
Attn: *Pennsylvania Bulletin*  
800 W. Church Rd.  
Mechanicsburg, Pennsylvania 17055-3198  
(717) 766-0211 ext. 2340  
(800) 334-1429 ext. 2340 (toll free, out-of-State)  
(800) 524-3232 ext. 2340 (toll free, in State)

Orders for subscriptions and other circulation matters should be sent to:

Fry Communications, Inc.  
Attn: *Pennsylvania Bulletin*  
800 W. Church Rd.  
Mechanicsburg, PA 17055-3198

Copyright © 1999 Commonwealth of Pennsylvania  
ISBN 0-8182-0004-9

Editorial preparation, composition, printing and distribution of the *Pennsylvania Bulletin* is effected on behalf of the Commonwealth of Pennsylvania by FRY COMMUNICATIONS, Inc., 800 W. Church Road, Mechanicsburg, Pennsylvania 17055-3198.

# THE GENERAL ASSEMBLY

## Recent Actions During the 1999 Regular Session of the General Assembly

The following is a summary of recent actions of the General Assembly during the 1999 Regular Session.

### 1999 ACTS—ACTS 7 THROUGH 21 (numerical)

<i>Act No.</i>	<i>Enact. Date</i>	<i>Bill No.</i>	<i>Prnr's No.</i>	<i>Effective Date</i>	<i>Subject Matter</i>
1999-07	June 16	SB832	PN1185	Immediately*	Governor Robert P. Casey Highway, Representative Joseph G. Wargo Exit and Columbia Boulevard—redesignations and designation
1999-08	June 18	HB124	PN1991	60 days	Crimes Code (18 Pa.C.S.)—omnibus amendments
1999-09	June 18	HB321	PN328	Immediately	Repeals—obsolete law relating to declaring part of Wallenpaupack Creek in Wayne County a public highway
1999-10	June 18	HB1335	PN1582	Immediately	Pennsylvania Municipalities Planning Code—methadone treatment facilities prohibited in certain locations
1999-11	June 18	SB646	PN1177	Immediately*	Second Class County Port Authority Act—omnibus amendments
1999-12	June 22	SB3	PN1244	Immediately	Judicial Code (42 Pa.C.S.) and State Government (71 Pa.C.S.)—omnibus amendments
1999-13	June 22	SB442	PN1195	60 days	Postsecondary institutions of higher learning—scholarship awards
1999-14	June 22	SB813	PN889	60 days	Military and Veterans Code (51 Pa.C.S.)—pensions for blind and paralyzed veterans
1999-15	June 22	SB970	PN1250	July 1, 1999	Administrative Code of 1929, The—omnibus amendments
1999-16	June 22	SB1000	PN1203	Immediately	Speaker Matthew J. Ryan Legislative Office Building—designation
1999-17	June 22	HB157	PN2109	60 days	Second Class Township Code, The—auditor's compensation
1999-18	June 22	HB192	PN981	Immediately	Project 500 lands—Commonwealth property in Lackawanna County
1999-19	June 22	HB779	PN2111	60 days	Crimes Code (18 Pa.C.S.)—police animals treatment and penalties
1999-20	June 22	HB979	PN1891	Immediately	Third Class County Assessment Board Law—auxiliary appeal boards
1999-21	June 22	HB1331	PN2112	Immediately*	Public Utility Code (66 Pa.C.S.)—natural gas utilities supply choice for customers and restructuring of industry

### 1999 APPROPRIATIONS—ACTS 25A through 43A (numerical)

<i>Act No.</i>	<i>Enact. Date</i>	<i>Bill No.</i>	<i>Prnr's No.</i>	<i>Effective Date</i>	<i>Subject Matter</i>
1999-25A	June 18	HB981	PN1756	July 1, 1999	Lincoln University—operation, instruction, accounting methods and fiscal information disclosure, etc.
1999-26A	June 18	HB982	PN1757	July 1, 1999	University of Pittsburgh—operation and instruction, etc.
1999-27A	June 18	HB983	PN1758	July 1, 1999	Pennsylvania State University—operation, instruction and research, etc.
1999-28A	June 18	HB984	PN1801	July 1, 1999	Temple University—operation and instruction, etc.
1999-29A	June 18	HB985	PN1759	July 1, 1999	Drexel University—instruction and student aid
1999-30A	June 18	HB992	PN1760	July 1, 1999	Pennsylvania College of Optometry—instruction and computer laboratory, etc.
1999-31A	June 18	HB994	PN1804	July 1, 1999	Philadelphia Health and Education Corporation, MCP Hahnemann University—instruction, operation, minority education and recruitment programs and pediatric services, etc.

<i>Act No.</i>	<i>Enact. Date</i>	<i>Bill No.</i>	<i>Prnr's No.</i>	<i>Effective Date</i>	<i>Subject Matter</i>
1999-32A	June 18	HB997	PN1105	July 1, 1999	Central Penn Oncology Group—operation University of Pennsylvania—cardiovascular studies
1999-33A	June 18	HB998	PN1106	July 1, 1999	
1999-34A	June 18	HB999	PN1107	July 1, 1999	Burn Foundation—treatment Fox Chase Institute for Cancer Research—operation and maintenance
1999-35A	June 18	HB1000	PN1108	July 1, 1999	
1999-36A	June 18	HB1001	PN1109	July 1, 1999	Lancaster Cleft Palate—treatment Pittsburgh Cleft Palate—treatment Children's Institute, The—treatment and rehabilitation of children and young adults with disabling diseases
1999-37A	June 18	HB1002	PN1110	July 1, 1999	
1999-38A	June 18	HB1003	PN1762	July 1, 1999	
1999-39A	June 18	HB1004	PN1802	July 1, 1999	Children's Hospital of Philadelphia, The—comprehensive patient care for children, maintenance and operation
1999-40A	June 18	HB1005	PN1113	July 1, 1999	St. Francis Hospital—cardiovascular studies Wistar Institute—operation, maintenance and AIDS research
1999-41A	June 18	HB1006	PN1114	July 1, 1999	
1999-42A	June 18	HB1022	PN1528	July 1, 1999	Pennsylvania Public Utility Commission—operation
1999-43A	June 18	SB740	PN1113	July 1, 1999	University of Pennsylvania—operation of clinics, instruction, veterinary activities and cardiovascular studies

\*with exceptions

#### Effective Dates of Statutes

The effective dates specified above for laws and appropriation acts were contained in the applicable law or appropriation act. Where no date is specified or where the effective date specified is prior to the date of enactment, the effective date is 60 days after final enactment except for statutes making appropriations or affecting budgets of political subdivisions. See 1 Pa.C.S. §§ 1701—1704 (relating to effective dates of statutes).

#### Advance Copies of Statutes

Section 1106 of Title 1 of the Pennsylvania Consolidated Statutes provides that the prothonotaries of each county shall file advance copies of statutes in their offices for public inspection until the Laws of Pennsylvania are generally available. Section 2406(h) of The Administrative Code of 1929 provides that the Department of General Services shall distribute advance sheets of the Laws of Pennsylvania to each law judge of the courts, to every county and public library of this Commonwealth, and to each member of the General Assembly. These copies shall be furnished without charge. The Department shall also mail one copy of each law enacted during any legislative session to any person who pays to it the sum of \$20.

Requests for annual subscriptions for advance copies of statutes should be sent to the State Bookstore, State Records Center Building, 1825 Stanley Drive, Harrisburg, PA 17103, accompanied by a check or money order in the sum of \$20, payable to the "Commonwealth of Pennsylvania."

CARL L. MEASE,  
*Director*  
*Legislative Reference Bureau*

[Pa.B. Doc. No. 99-1046. Filed for public inspection July 2, 1999, 9:00 a.m.]

# THE COURTS

## Title 255—LOCAL COURT RULES

### SCHUYLKILL COUNTY

#### Amendment of Rule of Judicial Administration 1901(b)(1)(a)

*And Now*, this 15th day of June, 1999, at 8:45 a.m., the Court hereby amends Schuylkill County Rule of Judicial Administration 1901(b)(1)(a) for use in the Court of Common Pleas of Schuylkill County, Pennsylvania (21st Judicial District). This rule shall be effective thirty days after publication in the *Pennsylvania Bulletin*.

The Prothonotary of Schuylkill County is Ordered and Directed to do the following:

- 1) File ten (10) certified copies of this Order and Rule with the Administrative Office of Pennsylvania Courts.
- 2) File two (2) certified copies of this Order and Rule with the Legislative Reference Bureau for publication in the *Pennsylvania Bulletin*.
- 3) File one (1) certified copy of this Order and Rule with the Pennsylvania Civil Procedural Rules Committee.
- 4) Forward one (1) copy to the Schuylkill County Law Library for publication in the *Schuylkill Legal Record*.
- 5) Keep continuously available for public inspection copies of this Order and Rule.

*By the Court*

WILLIAM E. BALDWIN,  
*President Judge*

#### Rule 1901: Termination of Inactive Cases.

(b)(1)(a) The Prothonotary shall prepare for call, on the first Monday of October of each year or on such other date as the Court by special order may direct, a list containing all civil matters in which no steps or proceedings have been taken for two years or more prior thereto and shall give notice thereof to counsel of record and to those parties for whom no appearance has been entered as required by Pa.R.J.A. No. 1901(c). If no good cause for continuing a matter is shown at the call of the list, the Court shall enter an order dismissing such matter.

Counsel and unrepresented parties who have received notice that a case is on the list of inactive cases may file a motion to remove the case from the purge list, alleging in said motion whatever facts may support good cause for continuing the matter. The motion must be filed not later than thirty-one (31) days prior to the call of the list, and the moving party shall immediately serve all other counsel of record and those parties for whom no appearance has been entered. A party opposing the motion must file an answer not later than seven (7) days prior to the call of the list. Every party who has filed a motion to remove a case from the list or an answer opposing such motion must be present at the call of the list in person or through counsel.

[Pa.B. Doc. No. 99-1047. Filed for public inspection July 2, 1999, 9:00 a.m.]

# RULES AND REGULATIONS

## Title 1—GENERAL PROVISIONS

### INDEPENDENT REGULATORY REVIEW COMMISSION

[1 PA. CODE CHS. 101, 201, 301, 303, 305, 307, 309, 311, 313 AND 315]

#### Practice and Procedure

By this order, the Independent Regulatory Review Commission (Commission) adopts the amendments to 1 Pa. Code (relating to general provisions), as set forth in Annex A. Commission is deleting Chapters 101 and 201 in their entirety and adding Chapters 301, 303, 305, 307, 309, 311 and 315.

These amendments delete Commission's regulations promulgated under the Regulatory Review Act (71 P. S. §§ 745.1—745.15) (act) as originally enacted, the act of June 25, 1982 (P. L. 633, No. 181). Because the subsequent reenactment and amendments drastically changed the structure of the review process, the prior regulations are largely inapplicable and unenforceable. For this reason, Commission has deleted them in their entirety.

Embargoed material is covered in these amendments. Therefore, Commission has also deleted in its entirety Chapter 201 (relating to embargoed material—statement of policy).

#### *Statutory Authority*

These amendments are adopted under the authority contained in section 11(a) of the act (71 P. S. § 745.11(a)).

#### *Background*

This rulemaking implement the act of June 25, 1997 (P. L. 252, No. 24) (Act 24) amendments to the act. These amendments respond to administrative and procedural concerns that have continually surfaced since the previous revision of the act in 1989. The Legislative intent of the act and the mission of the Commission remain the same. However, the process has been streamlined and made more flexible, saving both the regulators and the regulated time and money.

The major changes brought about by the Act 24 amendments are as follows:

- Define terms that are widely used in the review process to insure their consistent application.
- Eliminate the responsibility of agencies to send copies or summaries of a final-form regulation to all parties who commented on the proposed regulation. Now agencies are only obliged to send this material to commentators who specifically request it.
- Allow the agency to toll the review process to make changes recommended by the Commission or the standing committee of the House or Senate committee designated to review the agency's regulations.
- Reduce the blackout period from 72 hours to 48 hours.
- Establish uniform procedures for the submittal and review of regulations and reports immediately prior to

and after the adjournment sine die of the General Assembly or the expiration of the Legislative session in even numbered years.

- Modify the time line for the Commission review of regulations to insure that the Commission has at least 10 days to consider committee comments and action.
- Restrict the Commission from reviewing an existing regulation that has been in effect for less than 3 years.

#### *Purpose*

The purpose of this rulemaking is twofold. First, it deletes obsolete regulations designed to implement the original version of the act that is no longer in effect. Second, it implements the latest revision to the act.

#### *Summary of Amendments*

Chapter 301 (relating to general provisions) sets forth the general provisions relating to the Commission's operation.

- Section 301.1 (relating to definitions) cross references terms defined in the act and defines additional commonly used terms and phrases to insure their consistent application. Terms and phrases defined in this section include: "blackout period," "deemed approved," "delivery," "embargoed material," "end of Legislative session," "existing regulation," "face sheet," "final regulation," "form letters," "LRB," "order," "public meeting," "regulatory analysis form," "regulatory review criteria," "Sunshine Act" and "transmittal sheet."

- Section 301.2 (relating to regulation files) implements section 5.1(k) of the act (71 P. S. § 745.5a(k)), which provides that Commission shall retain public records on regulations for 4 years after promulgation. This provision: (1) clarifies Commission's timetable for retaining files of regulations which are withdrawn or deemed withdrawn, or final regulations that have not been promulgated; (2) lists the materials that are retained in the public files; and (3) provides that after Commission takes final action on a regulation, the file will be closed, and only documents addressed to Commission will be included in a closed file.

- Section 301.3 (relating to determination of date and time of delivery) establishes how Commission determines and confirms the date and time of delivery of documents.

- Section 301.4 (relating to expiration of time period for delivery) establishes how Commission will determine when the committee and Commission review periods expire. Generally, if the allotted time ends on a day when Commission or committee is closed because of a holiday, weekend or an emergency, the review period is extended to the first business day thereafter.

- Section 301.6 (relating to delivery of a regulation to the wrong committee) provides direction to the agency when a regulation is inadvertently delivered to the wrong committee.

- Section 301.7 (relating to withdrawal of a regulation) describes the effects of a withdrawal or deemed withdrawal of a regulation.

- Section 301.8 (relating to agency contact person) requires an agency to designate a contact person to receive documents transmitted by Commission.

- Section 301.9 (relating to procedure for public hearings) implements section 11(c) of the act (71 P. S.



§ 745.11(c)). It establishes when and how Commission may conduct a public meeting.

Chapter 303 (relating to meetings of the Commission) describes how Commission meetings will be conducted.

- Section 303.1 (relating to notice of Commission public meetings; participation; minutes) provides that Commission will: (1) give notice of and conduct its meetings in accordance with the Sunshine Act, 65 Pa.C.S. §§ 701—716; and (2) notify an affected agency and committees of a rescheduled meeting, in accordance with section 4(h) of the act (71 P. S. § 745.4(h)).

- Section 303.2 (relating to blackout period) outlines Commission's handling of documents received during the blackout period.

- Section 303.3 (relating to quorum) implements section 4(i) of the act. It provides that three members of Commission must be physically present to constitute a quorum. Once a quorum is present, the remaining members of Commission may participate and vote by teleconference or proxy.

- Section 303.4 (relating to proxy voting) establishes the procedures for proxy voting. It provides that the proxy shall be: (1) in writing, signed by the Commissioner and addressed to the Chairperson at Commission's office address; and (2) delivered by first class mail or facsimile, prior to the commencement of the public meeting. The Commissioner must file a separate proxy for each vote. The Chairperson or a delegate will present the proxy at the time of the vote on the regulation, and the proxy will be recorded as the Commissioner's vote.

Chapter 305 (relating to procedures of delivery and review of proposed regulation) implements section 5 of the act (71 P. S. § 745.5). It outlines the procedures for delivery and review of proposed regulations

- Section 305.1 (relating to procedures for delivery and review of proposed regulation) provides that an agency shall deliver a proposed regulation on the same date to the Commission, the committees and the LRB, lists the material which must accompany the regulation and incorporates the uniform sine die provisions in section 5(f) of the act if delivery is precluded due to the end of the Legislative session.

- Section 305.2 (relating to delivery of comments and information by an agency) outlines the agency's responsibility for delivering comments it has received to Commission and committees.

- Section 305.3 (relating to Commission review period) provides that Commission has 10 days after the expiration of the committee review period to complete its review of the regulation.

- Section 305.4 (relating to Commission comments on a proposed regulation) outlines the procedure for Commission delivery and agency receipt of Commission's comments. It provides that if Commission has not objected to a provision in the proposed regulation, subsequent disapproval of the final-form regulation may only be based on changes made to the proposed regulation, or recommendations from a committee.

Chapter 307 (relating to procedures for delivery and review of final regulations) implements section 5.1 of the act. It outlines the procedures for delivery of final-form and final-omitted regulations.

- Section 307.1 (relating to two-year period for promulgation) requires an agency to deliver a final-form regulation within 2 years of the close of the public comment

period. If an agency does not meet this deadline, the regulation is deemed withdrawn.

- Sections 307.2 and 307.3 (relating to delivery of a final-form regulation; and delivery of a final-omitted regulation) provide for the delivery of final-form regulations, lists the materials which must accompany the regulation and incorporates uniform sine die provisions in section 5.1(f) of the act, if delivery is precluded due to the end of the Legislative session.

- Section 307.4 (relating to tolling the review period) outlines the procedures to be followed by an agency and the Commission if the agency tolls the review period. It also establishes how the Commission calculates the resumption of the review period after the tolled regulation has been delivered.

- Section 307.5 (relating to procedure for tolling) provides that: (1) the Commission has 10 days for review after the expiration of the committee review period; (2) the Commission's review period may be extended if the Commission action is precluded due to lack of a quorum; and (3) the Commission will consider all comments received in determining whether a regulation meets the regulatory review criteria.

Chapter 309 (relating to action on regulations) implements section 6 of the act (71 P. S. § 745.6). It outlines the actions the Commission and committees may take on regulations, and the results of specific actions.

- Section 309.1 (relating to Commission and committee action on a final regulation) provides that if the Commission and the committees approve or are deemed to have approved a regulation, the agency may proceed with promulgation. This provision also outlines what must occur for a regulation to be deemed approved.

- Section 309.2 (relating to Commission approval/committee disapproval of a final regulation) provides that if Commission approves a regulation, which a committee has disapproved, Commission must notify the disapproving committee within 2 business days of its approval.

Chapter 311 (relating to procedures for review of disapproved final regulations) outlines the procedures for subsequent review of disapproved final-form and final-omitted regulations.

- Section 311.1 (relating to Commission disapproval of a final regulation) implements section 6(a) and (b) of the act. It provides that Commission's disapproval order will: (1) specify the review criteria which the regulation failed to meet; (2) be delivered to the LRB, the committees and the agency; and (3) bar the agency from promulgating the regulation until subsequent Commission and committee review is completed.

- Section 311.2 (relating to response by an agency to Commission disapproval) implements section 7(a) and (a.1) of the act (71 P. S. § 745.7(a) and (a.1)). It requires the agency to notify the Commission and the committees within 7 days whether the agency will withdraw, resubmit without revision or revise a disapproved regulation. This provision cross references section 7(a.1) of the act if the agency is precluded from delivering its notification because of the end of the Legislative session.

- Section 311.3 (relating to subsequent review of regulation without revisions or modifications) implements section 7(b) of the act. It provides for: (1) agency delivery of a report to the committees if the agency decides to resubmit a disapproved regulation without revision; (2) materials the report must contain; (3) the time period for

committee review of the report; and (4) a cross reference to section 7(d) of the act, which outlines the concurrent resolution process.

- Section 311.4 (relating to delivery of regulation with revisions) implements section 7(c) of the act. It provides for: (1) agency delivery of a report to the Commission and committees if the agency decides to revise and resubmit the regulation; (2) material that the report must contain; (3) the time period for the Commission and committee review of the report; and (4) a cross reference to section 7(d) of the act, which outlines the concurrent resolution process.

Chapter 313 (relating to emergency certified regulations) implements section 6(b) the act. It outlines the procedures for the delivery and review of emergency certified regulations.

- Section 313.1 (relating to general) describes when and how an agency may submit a final-form or final-omitted regulation certified as an emergency by either the Governor or Attorney General.

- Section 313.2 (relating to review of an emergency certified final regulation) establishes that an emergency certified regulation takes effect immediately upon publication in the *Pennsylvania Bulletin*. If disapproved, the regulation will be rescinded after 120 days or upon final disapproval under section 7(d) of the act, whichever occurs later. This provision also incorporates the statutory and regulatory tolling provisions.

Chapter 315 (relating to existing regulations and unpublished documents) outlines the procedures for review of existing regulations and statements of policy.

- Section 315.1 (relating to review of an existing regulation) implements section 8.1 of the act (71 P.S. § 745.8a). It provides that: (1) the Commission may review an existing regulation which has been in effect for at least 3 years; (2) if warranted, the Commission will notify the agency of issues raised and request a response; and (3) after a review of all pertinent material, the Commission will issue a report to the agency, committees, Governor and Attorney General setting forth its findings and recommendations.

- Section 315.2 (relating to review of an unpublished document) implements section 7.1 of the act (71 P.S. § 745.7a). It provides that if the Commission finds a published or an unpublished document should be promulgated as a regulation, it may present the matter to the Joint Committee on Documents.

*Fiscal Impact and Paperwork Requirements*

These amendments do not create a negative fiscal impact or an increased paperwork requirement. In fact, allowance for electronic and facsimile transmission of documents will reduce paperwork.

*Summary of Public Comments and Changes*

These amendments were published as proposed 29 Pa.B. 980 (February 20, 1999). The regulations were also published on the Commission's website at [www.irrc.state.pa.us](http://www.irrc.state.pa.us). Written comments, suggestions or objections were requested within a 45-day period after publication of the proposed amendments. Comments were received from the Office of General Counsel, the Office of Attorney General and the Hospital and Healthsystems Association of Pennsylvania. Under section 11(a) of the act (71 P.S. § 745.11(a)), the Joint Committee on Documents also filed comments. Following is a summary of the comments,

the Commission's response to those comments and the changes to the proposed rulemaking.

*Comment*

In § 301.1, the definition of the term "regulation" is not the same as the definition of the term as it appears in the act. To maintain consistency, the definition of the term in the regulation should be changed to mirror the definition in the act. Also, in the definition of "embargoed material," the word "entity" should be replaced with "agency," since that is the term used in the act.

*Response*

The definition of "regulation" has been replaced with a cross reference to section 3 of the act. The Commission did not replace "entity" with "agency" in the definition of "embargoed material" because the blackout established in section 5.1(j) of the act applies to both public and agency comments. To clarify the act's intent, the phrase "any entity" has been replaced with "anyone."

*Comment*

In § 301.2(b)(2), the phrase "correspondence from the Attorney General" should be deleted to avoid confusion.

*Response*

The phrase "correspondence from the Attorney General" has been deleted from § 301.2(b)(2).

*Comment*

In § 301.3(b), the regulation references the "date and time of delivery" of a regulation. It is more appropriate for the regulation to reference the date and time of receipt, since receipt is the defining event.

*Response*

"Delivery" has been defined to mean both the deposit of regulations and other material with the Commission and the deposit of orders and other material with agencies and other parties. Because delivery and receipt are simultaneous events, a change in language is not necessary.

*Comment*

In § 301.3(b), "shall" should be replaced with "should." The Commission should continue to confirm receipt of an agency regulation.

*Response*

This provision is intended to refer to public commentators and not promulgating agencies. The Commission has always given agencies confirmation of its receipt of regulations. Generally, this is accomplished by returning a copy of the signed transmittal sheet to the agency. The Commission has no intention of discontinuing this practice. To clarify the intent of this provision, the word "sender" has been replaced with "commentator."

*Comment*

It is unnecessary to reference "legal holidays" in §§ 301.4 and 301.5, because the other enumerated days in these sections would encompass all "legal holidays."

*Response*

The Statutory Construction Act, 1 Pa.C.S. § 1908 (relating to computation of time), provides that whenever the last day of a period of time falls on a Saturday, Sunday or legal holiday, that day shall be omitted from the computation of time for that period. Therefore, it is not necessary to reference Saturday, Sunday or legal holidays in the provisions relating to the Commission's and the committees' review periods. To make the regulation more concise, these references have been deleted.

*Comment*

The requirement in proposed § 301.6 that a person receiving a regulation on behalf of a committee chairperson, Attorney General or the LRB sign the transmittal sheet with a full name, not initials, will impede the effective delivery of a regulation.

*Response*

This section, relating to signature on transmittal sheet, has been deleted.

*Comment*

Proposed § 301.6(b) and (c) (now § 301.6) were unnecessary. The phrase "designated committee" should be changed to "correct committee." "Delivery" should be replaced with "receipt."

*Response*

Subsections (b) and (c) have been deleted. Also, "designated committee" has been changed to "correct committee" for clarity. However, because "delivery" has been defined as the deposit of regulations with the committees, and delivery and receipt are simultaneous events, "delivery" will not be replaced with "receipt."

*Comment*

The requirement in proposed § 301.9 (now § 301.8) that agencies designate a single contact person would create an impediment to the efficient operation of the regulatory process from the agencies' perspective. Not all agencies are structured so that a single person acts as a regulatory coordinator who is immediately available to receive Commission documents sent by facsimile or electronic mail. Another concern is that documents should not be deemed delivered if sent by e-mail or facsimile.

*Response*

The Commission agrees that it may not be practical for an agency to designate a single person to function as a contact person. Likewise, it may not always be presumed that delivery is made upon facsimile or electronic transmission. Therefore, the phrase "or office" will be added at the end of the first sentence. The phrase "or office and delivery is confirmed" will be added at the end of the second sentence.

*Comment*

In § 303.2(a), the use of the term "party" is imprecise. Technically, the agency is the only party to a regulation. In subsection (b), the term "embargoed" should be replaced with "embargoed material," which is a defined term.

*Response*

Consistent with the change in the definition of "embargoed material," "any party" has been replaced with the term "anyone." In subsection (b), "material" has been added after "embargoed."

*Comment*

The Commission's statutory authority for establishing a procedure for proxy voting in § 303.4 is questioned.

*Response*

The Commission derives statutory authority for establishing a procedure for proxy voting from sections 2(a) and 4(a)(i) and 11(a) of the act (71 P.S. §§ 745.2(a)(i), 745.4(a)(i) and 745.11(a)). Section 2(a), relating to Legislative intent, provides, in part:

... The General Assembly finds that it must establish a procedure for oversight and review of regula-

tions adopted pursuant to this delegation of legislative power in order to curtail excessive regulation and to require the executive branch to justify its exercise of the authority to regulate before imposing hidden costs upon the economy of Pennsylvania. It is the intent of this act to establish a method for ongoing and effective legislative review and oversight in order to foster executive branch accountability; to provide for primary review by a commission with sufficient authority, expertise, independence and time to perform that function. . . (Emphasis added.)

Section 4(a) of the act, relating to the composition of the Commission, provides for representation of all four Legislative caucuses and the Governor. Bipartisan representation insures the Commission's independence.

Section 4(i) of the act provides that the only restriction on conducting Commission business is that three members be physically present to constitute a quorum. However, the provision does not limit or restrict the manner of participation for Commissioners who are not part of the quorum.

Section 11(a) of the act affords the Commission broad authority to establish procedures for conducting its business. That section provides in part:

The commission, in the performance of its functions under this act, has the power to promulgate and enforce regulations necessary to carry out the purposes of this act. (Emphasis added.)

These four provisions, read in pari materia, contemplate that the Commission will be an independent body, actively and continuously engaged in reviewing executive agency regulations. The proxy voting procedure implements the act by providing a Commissioner with the means to carry out this Legislative mandate in those instances when the Commissioner is unable to attend a Commission meeting at which a quorum is present.

*Comment*

The second sentence of § 305.1(a) prohibits agencies from the simultaneous delivery of regulations to the committees and the Commission in situations where time is of the essence. It should not matter whether the Commission is the last to receive the regulation. Further, the act does not require that the Commission be the final recipient of any regulation.

*Response*

In §§ 305.2(a), 307.2(a) and 307.3(a), the second sentence, providing that delivery to the Commission after delivery to the committees and, in the case of final-omitted regulations, to the Attorney General, has been deleted. The purpose of this sentence was to insure that delivery is made to the Commission and committees on the same day, as required in the act. Confirmation that delivery is made in accordance with the act is necessary for the Commission to accurately set its timeline for review. However, this is accomplished through §§ 305.2(b)(3), 307.2(c)(3) and 307.3(b)(3), which provide that the agency deliver a signed transmittal sheet indicating receipt by the committees and Attorney General.

*Comment*

The requirement in §§ 305.1(b)(4), 307.2(c)(4) and 307.3(b)(4), that the agency head or Office of General Counsel certify that the regulation was delivered to the committees in accordance with the act, is problematic. The act does not require this certification. Furthermore, the agency head and Office of General Counsel would not

have first hand knowledge of the manner of delivery, and would have to issue this certification upon the representations of the messenger. Because this certification would not be based upon first hand knowledge, it would expose the certifying individual to adverse consequences if the certification were inaccurate and do little to assure the regulation was delivered correctly.

*Response*

This requirement has been deleted. As noted previously, delivery of the signed transmittal sheet will provide assurance that the regulation has been delivered in accordance with the act.

*Comment*

The provisions of § 305.2(a) are inconsistent with the act in that they expands the agencies' duty to deliver public comments well beyond the public comment period and obligates agencies to forward comments until the expiration of the Commission's review period.

*Response*

A cross reference to § 305.3 has been added, indicating that the requirement that agencies deliver comments received to the Commission extends only through the Commission's review period. This requirement is consistent with section 5(c) of the act.

*Comment*

Section 305.4(e)(2) allows the Commission to disapprove a final-form regulation on the basis of changes that the agency made to the final-form regulation. It is not clear whether this provision allows disapproval on the basis of additions to the final-form regulation.

*Response*

Section 305.4(e)(2) has been revised to indicate that changes such as revisions, deletions or additions may form the basis of Commission disapproval of a final-form regulation.

*Comment*

Section 307.2(b) requires the agency to mail a copy of the regulation or a summary of the changes to commentators who request information on the final-form regulation. The Commission should require agencies to send a copy of the final-form regulation, not just a summary of the changes.

*Response*

The language of § 307.2(b) has been changed to mirror the language in section 5.1(b) of the act. Rather than requiring only a summary of the changes from the proposed regulation, the provision now requires agencies to send a "copy of the text of the final-form regulation or copy of all changes to the proposed regulation which are incorporated into the final-form regulation."

*Comment*

Not all agencies have adopted the drafting convention in § 307.2(c)(7) and 307.3(b)(5). Some agencies use bold or highlighted text to indicate changes in final-form regulations. So long as the changes are immediately apparent and consistent throughout the regulation, the agencies should retain the discretion to choose how to best reflect these changes.

*Response*

The Commission believes that changes to executive agency regulations should be indicated in a consistent manner. Doing so will avoid confusion by the General

Assembly and the public as to the scope of the changes. Accordingly, §§ 307.2(c)(6) and 307.3(b)(5) will not be changed.

*Comment*

Sections 307.4 and 307.5 do not provide an opportunity for commentators to comment on changes to a tolled regulation. The Commission should establish a reasonable period of time for comment for changes made to a final-form regulation as a result of the tolling process.

*Response*

This section will not be changed. The act does not impose any requirement on agencies to notify commentators that the time for review of a regulation has been tolled or provide commentators with an additional period of time to review the changes made during the tolling period. Although the act does not require agencies to share revised regulations with commentators, they are clearly not prohibited from doing so.

Two important statutory provisions safeguard against changes made during the tolling period which may arbitrarily impose new requirements on regulated parties without prior notice. First, tolling is limited to changes recommended by the Commission and the committees. Second, the review period may not be tolled if the Commission objects. The Commission may object if the scope of the changes exceeds the recommendations of the Commission or a committee.

*Comment*

Section 307.4 inappropriately restricts the tolling provisions in the act. The phrase "and this section" should be deleted from subsection (a). The act contains the requirements for tolling, and the regulation should not restrict or expand the circumstances regarding the procedure for tolling a regulation.

*Response*

The Commission is authorized to promulgate regulations to implement the act. With the changes discussed, the Commission finds that the regulations implement the act without imposing new requirements on agencies. Therefore, the phrase "and this section" is appropriate and will not be deleted.

*Comment*

Section 307.4(c) and (f) inappropriately restrict the ability of an agency to toll the review of a regulation. An agency may toll on its own initiative, and without the suggestion of the committees or Commission. Furthermore, the process established in the regulation is somewhat inefficient. When an agency notices an error with the citation in a regulation, it is counterintuitive for the agency to suggest to the Commission or committees that the review period needs to be tolled for the regulation to be amended. Then, the agency must have the Commission or the committees suggest to the agency that it toll the review period in order to make the change. In addition, the second sentence of subsection (f) is outside the scope of the act.

*Response*

Section 5.1(g)(1) of the act provides in part: "... the agency may, unless the commission shall object, toll the time for the commission's and the committees' review of the final-form or final-omitted regulation in order to allow time for the agency to consider *revisions to the final-form or final-omitted regulation recommended by the commission or a committee.*" (Emphasis added). The language of subsection (c) has been revised to more closely mirror this

language of the act. The word "only" has been deleted and the word "make" has been replaced with "consider." The second sentence of subsection (f) has been revised to more accurately reflect the circumstances under which the Commission may exercise its discretion to object to the tolling of the review period.

*Comment*

Section 307.5(b) is unduly restrictive and inconsistent with the act. The act provides that an agency may toll the review period to "consider revisions." It does not require the agency to make any revisions or have specific revisions in mind when it tolls the review period. Subsection (b) assumes that the agency has a solution to address a problem with a regulation before the review period is tolled. Agency consideration during the tolling period may result in no change or a change that was not known at the time the review period was tolled. The reason for the 30-day tolling period is to permit the agency to re-examine the regulation, consider revisions and to make a determination as to the best way to proceed. The act does not require the agencies to have the answers in advance.

*Response*

Subsection (b) is designed to require the agency to provide the Commission with the minimum information necessary for it to determine whether it should object. This provision has been revised for greater consistency with the act and other provisions in this section.

Section 307.5 allows for the possibility that the agency may ultimately decide not to revise the regulation. In this instance, the agency need only provide the Commission with written notice that the regulation will not be revised.

*Comment*

Subsections (l) and (m) of § 307.5 are unnecessary, as they are provided for expressly in the act.

*Response*

Subsection (l), like subsection (k), outlines the time for review once a regulation is returned to the review process. Although the committee and Commission review periods are established in the act, inserting these provisions in the regulation provides an easily accessible reference point and avoids confusion as to the starting and ending dates of each review period. Therefore, subsection (l) will be retained. However, subsection (m), which provides a cross reference to the sine die provisions in the act, will be deleted. Because the statutory sine die provisions are detailed and comprehensive, the cross reference may be deleted in the interest of conciseness. Similar cross references will be deleted from §§ 305.1(c), 307.2(d) and 307.3(c).

*Additional Changes*

In addition to the changes made in response to the comments received, the Commission made the following additional changes:

- In the definition of "delivery," the words "or committees" were added after "Commission" in subparagraph (i). This change clarifies the use of the term "delivery" in § 301.6.
- In § 301.8 (relating to agency contact person), the words "e-mail address" were added after "address" in the first sentence.
- To accurately reflect the Commission's recently adopted practice of holding one public session instead of two on scheduled meeting days, the definition of "staff

review meeting" has been deleted and the definition of "public meeting" has been revised. Corresponding changes have been made to §§ 303.1 and 303.2.

- To clarify that a notice of intent to toll must be delivered prior to the beginning of the blackout period, § 307.4(d) has been revised.

*Tolling*

On June 7, 1999, the review period was tolled, and the regulation was resubmitted with revisions recommended by the House State Government Committee and the Senate Rules and Executive Nominations Committee. The revisions were as follows:

1. The reference to "staff review meeting" was deleted from the definition of "blackout period." The staff review is now a part of the public meeting, and is no longer a separate session. This revision is consistent with similar revisions made throughout the regulations, and tracks the change in the Commission's meeting procedure.
2. The definition of "deemed approved" was revised to improve its clarity.
3. In the definition of "delivery," the reference to "other parties" was deleted and replaced with "persons."
4. In the definition of "end of Legislative session," the word "regular" was inserted before "Legislative." This change will insure that sine die adjournment is not confused with the end of a special Legislative session.
5. In the definition of "Sunshine Act," the statutory citation was corrected.
6. In §§ 301.4 and 301.5, the references to Saturday, Sunday and legal holiday were restored to improve clarity.
7. In § 303.4(a)(2), "commencement of the public meeting" was deleted and replaced with "vote." Accordingly, a proxy may be presented anytime before the vote is taken.
8. In § 303.4(b), the reference to "a delegate" was deleted and replaced with "another Commissioner or the Executive Director." This change clarifies who may deliver a proxy vote.
9. In § 307.5(g), the second sentence was deleted. In § 307.5(h), the phrase "signed by the committees" was added after "sheet." These revisions are consistent with similar revisions to the regulation, which clarify that a regulation does not have to be delivered to the Commission last. However, a completed transmittal sheet must be delivered with the regulation.

10. In § 309.1(a), the word "present" was deleted and replaced with "participating." This change clarifies that the votes of members who are participating either by telephone or proxy are counted toward the majority.

11. In § 309.2(a), revisions were made to clarify the provision's application to situations where a regulation is either approved or deemed approved.

*Regulatory Review*

Under sections 5(a) and 11(a) of the act, Commission submitted a copy of the proposed amendments on February 9, 1999, to the Joint Committee on Documents, the Senate Rules and Executive Nominations Committee and the House State Government Committee. In addition to submitting the proposed amendments, Commission has provided the Joint Committee on Documents and the Committees with a copy of a completed Regulatory Analysis Form. A copy of this material is available to the public upon request.

In compliance with section 5.1(a) and (b) of the act, Commission also provided the Joint Committee on Documents and the Committees with copies of all comments received.

In preparing these final-form regulations, the Commission has considered all comments received from the Joint Committee on Documents, the Committees and the public.

These final-form regulations were submitted to the Senate Rules and Executive Nominations Committee, the House State Government Committee and the Joint Committee on Documents on May 20, 1999. On June 7, 1999, the review period was tolled and the final-form regulations were resubmitted with revisions recommended by both Committees. The final-form regulations were approved by the Senate Rules and Executive Nominations Committee on June 14, 1999, by the House State Government Committee on June 8, 1999, and by the Joint Committee on Documents on June 21, 1999, in accordance with sections 5.1(d) and (e) of the act.

*Findings*

Commission finds that:

(1) Public notice of intention to adopt the administrative regulations adopted by this order has been given under sections 201 and 202 of the act of July 31, 1968 (P. L. 769, No. 240) (45 P. S. §§ 1201 and 1202) and the regulations thereunder in 1 Pa. Code §§ 7.1 and 7.2.

(2) The adoption of these amendments in the manner provided in this order is necessary and appropriate for the administration and enforcement of the act.

*Order*

The Commission, acting under the act, orders that:

(a) The regulations of Commission, Chapters 101, 201, 301, 303, 305, 307, 309, 311, 313 and 315, are amended by deleting §§ 101.1—101.11 and 201.1—201.3 to read as set forth at 29 Pa.B. 980 (February 20, 1999) and by adding §§ 301.1—301.9, 303.1—303.4, 305.1—305.4, 307.1—307.6, 309.1, 309.2, 311.1—311.4, 313.1, 313.2, 315.1 and 315.2 to read as set forth in Annex A.

(b) The Chairperson of Commission shall certify this order, 29 Pa.B. 980 and Annex A and deposit them with the Legislative Reference Bureau as required by law.

(c) This order shall take effect upon publication in the *Pennsylvania Bulletin* as final rulemaking.

JOHN R. MCGINLEY, Jr.,  
Chairperson

**Fiscal Note:** Fiscal Note 70-6 remains valid for the final adoption of the subject regulations.

**Annex A**

**TITLE 1. GENERAL PROVISIONS**

**PART III. INDEPENDENT REGULATORY REVIEW COMMISSION**

**CHAPTER 301. GENERAL PROVISIONS**

Sec.	
301.1.	Definitions.
301.2.	Regulation files.
301.3.	Determination of date and time of delivery.
301.4.	Expiration of time period for delivery.
301.5.	Expiration of committee and Commission review periods.
301.6.	Delivery of a regulation to the wrong committee.
301.7.	Withdrawal of a regulation.
301.8.	Agency contact person.
301.9.	Procedure for public hearings.

**§ 301.1. Definitions.**

The following words and terms, when used in this part, have the following meanings, unless the context clearly indicates otherwise:

*Act*—The Regulatory Review Act (71 P. S. §§ 745.1—745.15).

*Agency*—As defined in section 3 of the act (71 P. S. § 745.3).

*Blackout period*—The 48-hour period immediately preceding the call to order of the public meeting.

*Commission*—As defined in section 3 of the act.

*Committee*—As defined in section 3 of the act.

*Commonwealth Attorneys Act*—As defined in section 3 of the act.

*Commonwealth Documents Law*—As defined in section 3 of the act.

*Deemed approved*—The approval of a regulation by the Commission or a committee by operation of law when the committee or the Commission has not approved or disapproved the regulation by majority vote.

*Delivery*—

(i) The deposit of regulations, correspondence or other documents with the Commission or committees through postal or other delivery service, hand delivery, electronic mail (e-mail) or facsimile.

(ii) The deposit of orders, comments, correspondence or other documents with agencies, committees or persons through postal or other delivery service, hand delivery, e-mail or facsimile.

*Embargoed material*—Documents pertaining to a regulation on the agenda for the Commission's public meeting delivered during the blackout period by anyone, except documents from the committee or a member of the committee.

*End of Legislative session*—The adjournment sine die or the expiration of the regular Legislative session in an even-numbered year.

*Existing regulation*—An enforceable regulation codified in the *Pennsylvania Code*.

*Face sheet*—A form accompanying a regulation for filing documents with the LRB, completed in accordance with the regulations of the Joint Committee on Documents. See 1 Pa. Code § 13.12 (relating to requirements as to form and size).

*Final regulation*—A final-form or final-omitted regulation.

*Final-form regulation*—As defined in section 3 of the act.

*Final-omitted regulation*—As defined in section 3 of the act.

*Form letters*—Letters which contain verbatim text.

*LRB*—The Legislative Reference Bureau of the Commonwealth.

*Order*—The statement of the Commission's findings and action on a final regulation, which is not subject to appeal.

*Promulgate*—As defined in section 3 of the act.

*Proposed regulation*—As defined in section 3 of the act.

*Public meeting*—The scheduled meeting of the Commission conducted in accordance with the Sunshine Act.

*Regulation*—As defined in section 3 of the act.

*Regulatory analysis form*—The form accompanying a regulation that contains the information required under section 5(a) of the act (71 P. S. § 745.5(a)).

*Regulatory review criteria*—The criteria delineated in section 5.1(h) and (i) of the act (71 P. S. § 745.5a(h) and (i)).

*Sunshine Act*—65 Pa.C.S. §§ 701—716.

*Transmittal sheet*—The form accompanying a regulation which lists the regulation number, the title of the regulation, the agency promulgating the regulation, the type of regulation, the date of delivery and the signatures of the persons receiving the regulation on behalf of the committees, the Commission, the Attorney General (for final-omitted regulations) and the LRB.

*Withdrawal*—As defined in section 3 of the act.

### § 301.2. Regulation files.

(a) The Commission will retain regulation files in accordance with the following schedule:

(1) *Promulgated regulations.* Four years after the date of promulgation.

(2) *Withdrawn or deemed withdrawn regulations.* Four years after the date of delivery of the proposed or final-omitted regulation to the Commission.

(3) *Final regulations which are not promulgated.* Four years after the date of delivery to the Commission.

(b) The files shall include the following materials:

(1) The original regulatory analysis form and the original regulation.

(2) Documents received, including comments, correspondence from the agency, transcripts and manuals.

(3) Subpoenas.

(4) Correspondence from the Commission.

(5) Commission comments.

(6) Commission orders.

(c) After the Commission takes final action on a regulation under section 6(a) or 7(c) of the act (71 P. S. §§ 745.6(a) and 745.7(c)), the Commission's regulation file will be closed. Only correspondence and documents addressed to the Commission or directed to the Commission's attention will be added to a closed regulation file.

(d) Upon request, a person may examine or copy the materials contained in the regulation files during the Commission's normal business hours.

(e) The Commission may charge a reasonable fee for copies of material contained in a regulation file.

### § 301.3. Determination of date and time of delivery.

(a) The Commission will determine the date and time of delivery of documents as follows:

(1) *E-mail.* As indicated on the Commission's computer system.

(2) *Fax.* As indicated on the transmittal report generated by the Commission's facsimile machine.

(3) *Postal or other delivery service.* As indicated on the Commission's time and date stamp.

(4) *Hand delivery.* As indicated on the Commission's time and date stamp.

(b) If the commentator requests confirmation of delivery of a hand-carried document, the commentator shall include an additional copy of the first page. The Commission will stamp the copy with the date and time of delivery and return it to the commentator. If the commentator requests confirmation of a document delivered through the postal or another delivery service, the commentator shall include an additional copy of the first page and a stamped, self-addressed envelope. The Commission will stamp the additional copy with the date and time of delivery and mail it to the commentator.

(c) If the commentator requests confirmation of delivery of an e-mailed or faxed document, the Commission will fax or e-mail confirmation of delivery to the commentator.

(d) The commentator shall have the responsibility to obtain confirmation that a document was delivered prior to the blackout period.

(e) The Commission will stamp the date and time of delivery of a regulation on the transmittal sheet and on the regulatory analysis form.

### § 301.4. Expiration of time period for delivery.

(a) The time period for an agency to deliver a regulation or report to the Commission or a committee will expire on the first business day after the expiration day established in the act or this part if that day is one of the following:

(1) A legal holiday.

(2) Declared a holiday by the Office of Administration.

(3) A day on which Commonwealth offices located in Harrisburg are closed due to emergency circumstances.

(4) A day on which the staff offices of the Senate or House of Representatives are officially closed.

(5) A Saturday or Sunday.

(b) A part-day holiday is considered a normal business day and not a day that would require the extension of a time period for delivery.

### § 301.5. Expiration of committee and Commission review periods.

(a) A committee review period will expire the first business day after the expiration day established under the act or this part if that day is one of the following:

(1) A legal holiday.

(2) Declared a holiday by the Office of Administration.

(3) A day on which Commonwealth offices located in Harrisburg are closed due to emergency circumstances.

(4) A day on which the staff offices of the Senate or House of Representatives are officially closed.

(5) A Saturday or Sunday.

(b) The Commission review period will expire on the first business day after the expiration day established under the act or this part if that day is one of the following:

(1) A legal holiday.

(2) Declared a holiday by the Office of Administration.

(3) A day on which Commonwealth offices located in Harrisburg are closed due to emergency circumstances.

(4) A Saturday or Sunday.

(c) A part-day holiday is considered a normal business day and not a day that would require the extension of a committee or Commission review period.

**§ 301.6. Delivery of a regulation to the wrong committee.**

(a) Immediately upon discovery that the agency has delivered a regulation to a committee other than a committee as defined in § 301.1 (relating to definitions), the agency shall deliver the regulation to the correct committee.

(b) With the delivery of a proposed regulation to the correct committee, the agency shall include all comments received since the beginning of the public comment period.

(c) The review period of the correct committee will begin as follows:

(1) For proposed regulations, the day after the close of the public comment period or the day after delivery, whichever is later.

(2) For final regulations, the day after delivery.

**§ 301.7. Withdrawal of a regulation.**

(a) If an agency withdraws or is deemed to have withdrawn a regulation, the Commission and the committees will cease their review of the regulation and will not take further action on the regulation.

(b) If the agency withdraws a proposed regulation, but subsequently desires to proceed with promulgation, the agency shall deliver a new proposed regulation in accordance with § 305.1 (relating to delivery of a proposed regulation).

(c) If the agency withdraws a final-form regulation after delivery to the Commission, but subsequently desires to proceed with promulgation, the agency may deliver a new final-form regulation in accordance with § 307.2 (relating to delivery of a final-form regulation), within 2 years from the close of the public comment period.

(d) If the agency desires to proceed with promulgation of a withdrawn regulation but does not submit a new final-form regulation within 2 years from the close of the public comment period, the agency shall deliver a new proposed regulation.

**§ 301.8. Agency contact person.**

An agency shall notify the Commission, in writing, of the name, title, address, e-mail address, telephone number and facsimile number of the agency representative or office designated to receive comments, orders, embargoed material and other documents, which the Commission delivers by facsimile or e-mail to the agency. Delivery is deemed made if sent by facsimile or e-mail to the designated agency representative or office and delivery is confirmed.

**§ 301.9. Procedure for public hearings.**

(a) The Commission may schedule public hearings on matters that are related to a proposed, a final or an existing regulation under review.

(b) Notice of a public hearing will be published in accordance with the Sunshine Act. The notice will include the date and time of the public hearing, the subject matter of the public hearing and the address where the public hearing will take place.

(c) The Chairperson will designate a hearing officer to preside at the public hearing. The hearing officer will be

charged with preserving order during the public hearing. The hearing officer may determine the agenda, the order of commentators and the time allotted to each commentator.

(d) When participating at a public hearing, commentators shall bring 10 written copies of their comments and supporting documents to the Commission.

**CHAPTER 303. MEETINGS OF THE COMMISSION**

Sec.	
303.1	Notice of Commission public meetings; participation; minutes.
303.2	Blackout period.
303.3	Quorum.
303.4	Proxy voting.

**§ 303.1. Notice of Commission public meetings; participation; minutes.**

(a) The Commission will give notice of its public meetings in accordance with the Sunshine Act.

(b) The Commission will deliver notice of a rescheduled public meeting to the committees and affected agencies at least 10-calendar days prior to the meeting date.

(c) Commission public meetings are conducted in compliance with the Sunshine Act.

(d) Minutes of public meetings will be available for public inspection at the Commission office during regular business hours.

**§ 303.2. Blackout period.**

(a) During the blackout period, Commissioners and Commission staff will not communicate with anyone, except a committee, committee member or committee staff person, regarding the substance of a regulation on the Commission's public meeting agenda.

(b) Comments and documents delivered by anyone, except a committee, committee member or committee staff person, during the blackout period will be embargoed material.

(c) Within 24 hours of receipt, the Commission will deliver embargoed material and committee comments received during the blackout period to the agency.

(d) Upon the call to order of the public meeting, embargoed material will be distributed to the Commissioners and Commission staff assigned to review the regulation.

**§ 303.3. Quorum.**

(a) For purposes of conducting official business, three Commissioners shall be physically present to constitute a quorum.

(b) Once a quorum is established, Commissioners may participate in meetings and vote on regulations by teleconference or proxy.

**§ 303.4. Proxy voting.**

(a) A Commissioner may vote by proxy on any issue before the Commission, including the approval or disapproval of a regulation, if the following conditions are met:

(1) The proxy shall be in writing, signed by the Commissioner and addressed to the Chairperson at the Commission's office address.

(2) The Commissioner will deliver the proxy to the Commission, either by first-class mail or facsimile, prior to the vote.

(3) The Commissioner will deliver a separate proxy for each vote.



(b) The Chairperson, another Commissioner or the Executive Director will present the proxy at the public meeting at the time of the Commission vote.

(c) The proxy shall be recorded as the Commissioner's vote.

#### **CHAPTER 305. PROCEDURES FOR DELIVERY AND REVIEW OF PROPOSED REGULATIONS**

Sec.

- 305.1. Delivery of a proposed regulation.
- 305.2. Delivery of comments and information by an agency.
- 305.3. Commission review period.
- 305.4. Commission comments on a proposed regulation.

##### **§ 305.1. Delivery of a proposed regulation.**

(a) The agency shall deliver a proposed regulation to the LRB, the committees and the Commission on the same date.

(b) The agency shall include the following material with the regulation:

- (1) A completed regulatory analysis form.
- (2) A face sheet signed by the Office of Attorney General and the Office of General Counsel or chief counsel of an independent agency.
- (3) A transmittal sheet signed by the committees.
- (4) The preamble and the text of the regulation set forth in an Annex A.

##### **§ 305.2. Delivery of comments and information by an agency.**

(a) From the date of delivery of the proposed regulation until the expiration of the Commission's review period as in § 305.3 (relating to Commission review period), the agency shall deliver to the Commission and committees copies of the following material relating to the regulation:

- (1) The comments received.
- (2) Reports from advisory groups.
- (3) Public notices or announcements regarding solicitation of public comments and information regarding meetings the agency has held or will hold.
- (b) The agency shall deliver copies of comments to the Commission within 5 days of its receipt of the comments.

(c) The agency shall deliver one copy of form letters received, and indicate the number of copies of that form letter it has received as of the date of delivery.

##### **§ 305.3. Commission review period.**

The Commission has 10 days after the expiration of the committee review period to review the regulation and deliver its comments to the agency. The Commission will calculate its review period as beginning the day after the expiration of the committee review period.

##### **§ 305.4. Commission comments on a proposed regulation.**

(a) The Commission will deliver its comments on a proposed regulation to the agency on or before the date the comments are due.

(b) To verify receipt of the comments by hand delivery, the agency staff person shall sign the Commission's receipt card. To verify receipt of the comments by facsimile, the agency staff person shall sign the cover sheet and send it back to the Commission by facsimile. To verify receipt of the comments by e-mail, the agency staff person shall send an e-mail message to the Commission indicating receipt of the comments.

(c) The comments shall contain objections to the regulation, specifying the regulatory review criteria that the regulation has not met. The comments may also contain recommendations for amendment of the regulation in final-form.

(d) If the Commission or a committee does not object to a provision in the proposed regulation by the expiration of its review period, and if the agency has not changed that provision in the final-form regulation, the Commission will be deemed to have approved that provision.

(e) The Commission may disapprove the final-form regulation only on the basis of one or more of the following:

- (1) Objections which the Commission raised in its comments on the proposed regulation.
- (2) Changes, such as revisions, deletions or additions, which the agency made to provisions in the final-form regulation.
- (3) Recommendations, comments or objections of a committee relating to the regulation.

#### **CHAPTER 307. PROCEDURES FOR DELIVERY AND REVIEW OF FINAL REGULATIONS**

Sec.

- 307.1. Two-year period for promulgation.
- 307.2. Delivery of a final-form regulation.
- 307.3. Delivery of a final-omitted regulation.
- 307.4. Tolling the review period.
- 307.5. Procedure for tolling.
- 307.6. Commission review of a final regulation.

##### **§ 307.1. Two-year period for promulgation.**

If an agency does not deliver, or withdraws and does not resubmit, a final-form regulation within 2 years of the close of the public comment period for the proposed regulation, the agency is deemed to have withdrawn the regulation.

##### **§ 307.2. Delivery of a final-form regulation.**

(a) The agency shall deliver a final-form regulation to the committees and the Commission on the same date.

(b) On the same date that the agency submits the regulation to the committees and the Commission, the agency shall send, by first class or electronic mail, a notice of submission and a copy of the text of the final-form regulation or a copy of all changes to the proposed regulation which are incorporated into the final-form regulation, to those commentators who requested information on the final-form regulation.

(c) The agency shall include the following documents with the regulation:

- (1) A completed regulatory analysis form relating to the final-form regulation.
- (2) A face sheet signed by the Office of General Counsel or chief counsel of an independent agency.
- (3) A transmittal sheet signed by the committees.
- (4) The agency's response to the comments received.
- (5) The preamble.
- (6) The text of the final-form regulation the agency intends to adopt indicating any changes made from the proposed regulation using the following format:

(i) Brackets to indicate language proposed to be deleted from the existing regulation.

(ii) Underscoring to indicate the new language proposed to be added to the existing regulation.

(iii) Strikeout type to indicate the new language in the proposed regulation which is deleted in the final-form.

(iv) Capital letters to indicate the new language in the final-form regulation which was not included in the proposed regulation.

(7) The names and addresses of commentators who requested additional information on the final-form regulation.

**§ 307.3. Delivery of a final-omitted regulation.**

(a) The agency shall deliver a final-omitted regulation to the committees, the Attorney General and the Commission on the same date.

(b) The agency shall include the following documents with the regulation:

- (1) A completed regulatory analysis form.
- (2) A face sheet signed by the Office of General Counsel or chief counsel of an independent agency.
- (3) A transmittal sheet signed by the committees and the Office of Attorney General.
- (4) The preamble.
- (5) The text of the final-omitted regulation indicating amendments to the existing regulation using the following format:

- (i) Brackets to indicate language deleted from the existing regulation.
- (ii) Underscoring to indicate language added to the existing regulation.

**§ 307.4. Tolling the review period.**

(a) After delivery of a final regulation to the Commission and committees, an agency may revise the regulation only if it tolls the review period in compliance with section 5.1(g) of the act (71 P. S. § 745.5a(g)) and this section.

- (b) An agency may only toll the review period one time.
- (c) The agency may toll the review period to consider revisions recommended by the Commission or a committee.

(d) The agency shall toll the review period prior to whichever of the following events occurs first:

- (1) The day on which either committee takes action on the regulation.
- (2) The expiration of the committee review period, if neither committee takes action.
- (3) The beginning of the blackout period.
- (e) The agency may only toll the review period for up to 30 days.

(f) The agency may not toll the review period if the Commission objects. The Commission may object if the agency indicates in its intent to toll that it is considering revisions that are broader than or inconsistent with those recommended by the Commission or a committee.

**§ 307.5. Procedure for tolling.**

- (a) The agency shall deliver written notice of its intention to toll to the Commission and the committees on the same date.
- (b) The written notice shall include the following:
  - (1) A citation to the section the agency is considering revising.

(2) A description of the revisions the agency is considering.

(3) An explanation of how the revisions the agency is considering will satisfy the Commission's or committee's concerns.

(c) The agency shall deliver the written notice of its intention to toll prior to the expiration of the committees' 20-day review period or the day on which either committee takes action on the regulation, whichever occurs first.

(d) If the Commission objects to the tolling, it will notify the agency and the committees of its objections within 2 business days after its receipt of the agency's notice.

(e) If the Commission objects, the review period will not be tolled and the regulation will be reviewed within the original time period established under section 5.1(d)—(f) of the act (71 P. S. § 745.5a(d)—(f)).

(f) The Commission will notify the agency, the committees, the Attorney General and the General Counsel of the first and 30th day of the tolling period.

(g) Before the expiration of the tolling period, the agency shall deliver a revised regulation, or a written notice that the regulation will not be revised, to the committees, the Commission and the Attorney General (for a final-omitted regulation) on the same date.

(h) The agency shall include a transmittal sheet signed by the committees with delivery of the regulation, or written notice that the regulation will not be revised.

(i) If the agency does not deliver a revised regulation, or written notice that the regulation will not be revised, before the expiration of the tolling period, the agency is deemed to have withdrawn the regulation. The Commission will notify the agency, the committees, the Attorney General and the Office of General Counsel that the regulation is deemed withdrawn.

(j) Upon receipt of the revised regulation, or written notice that the regulation will not be revised, the Commission will notify the agency, the committees, the Attorney General and the Office of General Counsel of the beginning and ending dates of the committee review period.

(k) The committees have the remainder of their 20-day review period or 10 days from the date of receipt of the revised regulation or written notice that the regulation will not be revised, whichever is longer, to approve or disapprove the regulation. The committee review period begins the day after the revised regulation or written notice is received.

(l) The Commission has 10 days after the expiration of the committee review period, or until its next regularly scheduled meeting, whichever is later, to approve or disapprove the original or revised regulation.

**§ 307.6. Commission review of a final regulation.**

(a) The Commission has 10 days after the expiration of the committee review period, or until its next regularly scheduled meeting, whichever is later, to approve or disapprove a final regulation. The Commission will calculate its review period as beginning the day after the expiration of the committees' review period.

(b) If the Commission is unable to approve or disapprove a final regulation because of the lack of a quorum, its review period will be extended for 30 days or until the next meeting at which a quorum is present, whichever occurs first.

(c) To determine whether the final regulation meets the regulatory review criteria, the Commission will consider comments from interested parties, members of the General Assembly and the committees, and the agency's response to those comments.

#### CHAPTER 309. ACTION ON REGULATIONS

Sec.	
309.1.	Commission and committee action on a final regulation.
309.2.	Commission approval/committee disapproval of a final regulation.

##### § 309.1. Commission and committee action on a final regulation.

(a) The Commission and each committee may approve or disapprove a final regulation by majority vote of members participating.

(b) If a committee does not approve or disapprove the regulation within 20 days of receipt, the committee is deemed to have approved the regulation.

(c) The Commission is deemed to have approved a final-form regulation if the following conditions apply:

(1) All of the following events occur:

(i) The Commission has not objected to the regulation as proposed.

(ii) The agency has not made changes in the final-form regulation which were not included in the proposed regulation.

(iii) A committee has not conveyed to the Commission or agency any recommendations, comments or objections.

(2) The Commission does not take action within the time period established under § 307.6 (relating to Commission review of a final regulation).

(3) The Commission's vote results in a tie.

(d) The Commission will notify the LRB, the committees and the agency of its action on a regulation.

(e) When the committees and the Commission approve or are deemed to have approved a regulation, the agency may proceed with promulgation of the regulation.

##### § 309.2. Commission approval/committee disapproval of a final regulation.

(a) When the Commission approves or deems approved a final regulation which one or both of the committees has disapproved, the Commission will deliver its approval order or notice indicating the regulation has been deemed approved to the disapproving committee and the agency within 2 business days after the approval or deemed approval.

(b) The agency may not promulgate the regulation for 14 days pending the report of a concurrent resolution from the disapproving committee, under section 7(d) of the act (71 P. S. § 745.7(d)).

(c) If the Commission is prevented from delivering the order or notice because of the end of the Legislative session, the Commission will deliver its order or notice under section 6(c) of the act (71 P. S. § 745.6(c)).

#### CHAPTER 311. PROCEDURES FOR REVIEW OF DISAPPROVED FINAL REGULATIONS

Sec.	
311.1.	Commission disapproval of a final regulation.
311.2.	Response by an agency to Commission disapproval.
311.3.	Subsequent review of regulation without revisions or modifications.
311.4.	Delivery of a regulation with revisions.

##### § 311.1. Commission disapproval of a final regulation.

(a) If the Commission disapproves a final regulation, the Commission will issue a disapproval order specifying the regulatory review criteria that the regulation has not met.

(b) The Commission will deliver its disapproval order to the LRB, the committees, the agency, the Attorney General and the commentators listed by the agency as having requested information on the final regulation.

(c) The Commission's disapproval order shall continue the bar on the promulgation of the regulation until the review provided under section 7 of the act (71 P. S. § 745.7) and this chapter is completed.

##### § 311.2. Response by an agency to Commission disapproval.

(a) Within 7 calendar days of receipt of the Commission's disapproval order, the agency shall provide written notification to the Governor, the committees and the Commission of its selection of one of the following three options:

(1) To proceed with promulgation of the regulation without revisions.

(2) To revise the regulation to respond to the Commission's objections.

(3) To withdraw the regulation.

(b) If the agency does not select an option within 7-calendar days after receipt of the Commission's disapproval order, the agency is deemed to have withdrawn the regulation.

(c) If the agency is prevented from notifying the committees of the option selected because of the end of the Legislative session, the agency shall proceed in accordance with section 7(a.1) of the act (71 P. S. § 745.7(a.1)).

##### § 311.3. Subsequent review of regulation without revisions or modifications.

(a) If the agency chooses to proceed with promulgation of the regulation without revision under § 311.2(a)(1) (relating to response by an agency to Commission disapproval), the agency shall deliver a report to the Commission and the committees within 40-calendar days of receipt of the Commission's disapproval order.

(b) The report shall contain the following:

(1) The final regulation.

(2) The Commission's disapproval order.

(3) The agency's response to the Commission's disapproval.

(4) A signed transmittal sheet.

(c) If the agency does not deliver the report within 40-calendar days of receipt of the Commission's disapproval order, the agency is deemed to have withdrawn the regulation.

(d) Upon receipt of the report, the committees may proceed in accordance with section 7(d) of the act (71 P. S. § 745.7(d)).

(e) If the agency is prevented from delivering its report to the committees because of the end of the Legislative session, the agency shall proceed in accordance with section 7(b) of the act.

**§ 311.4. Delivery of a regulation with revisions.**

(a) If the agency chooses to revise or modify the final regulation under § 311.2(a)(2) (relating to response by an agency to Commission disapproval), the agency shall deliver a report to the committees and the Commission within 40-calendar days of receipt of the Commission's disapproval order.

(b) The report shall contain the following:

- (1) The revised final regulation.
- (2) The Commission's disapproval order.
- (3) A detailed explanation of how the revisions respond to the Commission's disapproval order.
- (4) A signed transmittal sheet.

(c) If the agency does not deliver the report within 40-calendar days of receipt of the Commission's disapproval order, the agency is deemed to have withdrawn the regulation.

(d) The committees have 10-calendar days from receipt of the report to approve or disapprove the report. If a committee does not disapprove the report within the 10-day period, that committee is deemed to have approved the report.

(e) The Commission has 7 days after the expiration of the committee review period, or until its next regularly scheduled meeting, whichever is later, to approve or disapprove the report. The Commission will calculate its review period as beginning the day after the expiration of the committee review period.

(f) If the Commission does not disapprove the report, the Commission is deemed to have approved the report.

(g) If the committees and the Commission approve or are deemed to have approved the report, the agency may proceed with promulgation of the revised final regulation.

(h) If the Commission or a committee disapproves the report, the bar on the promulgation of the final regulation shall continue until the review provided under section 7(c) and (d) of the act (71 P. S. § 745.7(c) and (d)) is completed.

(i) If the agency is prevented from delivering its report to the committees because of the end of the Legislative session, the agency shall proceed in accordance with section 7(c) of the act.

(j) If the Commission is prevented from delivering its approval or disapproval order to the committees because of the end of the Legislative session, the Commission will deliver its order in accordance with section 7(c) of the act.

**CHAPTER 313. EMERGENCY CERTIFIED REGULATIONS**

Sec.	
313.1.	General.
313.2.	Review of an emergency certified final regulation.

**§ 313.1. General.**

(a) An agency may deliver a final regulation as an emergency certified regulation in either of the following situations:

- (1) The Attorney General certifies that the regulation is required to satisfy the order of a State or Federal court, or to implement the provisions of a Federal statute or regulation.
- (2) The Governor certifies that the regulation is required to avoid an emergency which may threaten the public health, safety or welfare, cause a budget deficit or

create the need for supplemental or deficiency appropriations of greater than \$1 million.

(b) The agency shall deliver the emergency certified final-form regulation and the certification from the Attorney General or the Governor in accordance with § 307.2 (relating to delivery of a final-form regulation).

(c) The agency shall deliver the emergency certified final-omitted regulation and the certification from the Attorney General or the Governor in accordance with § 307.3 (relating to delivery of a final-omitted regulation).

**§ 313.2. Review of an emergency certified final regulation.**

(a) An emergency certified final regulation shall take effect immediately upon publication in the *Pennsylvania Bulletin*, or on the date specified in the agency's adoption order.

(b) Review of an emergency certified regulation shall be in accordance with Chapters 307, 309 and 311 (relating to procedures for delivery and review of final regulations; action on regulations; and procedures for review of disapproved final regulations). If the emergency certified regulation is disapproved, the regulation shall be rescinded after 120 days or upon final disapproval under section 7(d) of the act (71 P. S. § 745.7(d)), whichever occurs later.

(c) Except as provided in section 5.1(g) of the act (71 P. S. § 745.5a(g)) and §§ 307.4 and 307.5 (relating to tolling the review period; and procedures for tolling), an agency may not make changes to an emergency certified regulation after the agency delivers the regulation to the Commission and the committees.

**CHAPTER 315. EXISTING REGULATIONS AND UNPUBLISHED DOCUMENTS**

Sec.	
315.1.	Review of an existing regulation.
315.2.	Review of an unpublished document.

**§ 315.1. Review of an existing regulation.**

(a) The Commission, on its own motion or at the request of any person or member of the General Assembly, may review an existing regulation which has been in effect for at least 3 years. If a committee of the Senate or House of Representatives requests the review, the Commission will assign it high priority.

(b) Upon delivery of a request to review an existing regulation, the Commission will initiate a preliminary review to determine whether further investigation is warranted.

(c) If the Commission determines that an investigation is not warranted, the matter will be closed. The Commission will notify the person or entity requesting the review of the existing regulation that no further action will be taken.

(d) If it is determined that an investigation is warranted, the Commission will notify the agency of the issues that have been raised and request a written response.

(e) After review of the agency's response and other relevant material, the Commission will issue a report setting forth its findings, conclusions or recommendations.

(f) The Commission will deliver its report to the agency, the committees, the Governor and the Attorney General.

The Commission's report may include recommendations for amendment of the statute that provides statutory authority for the regulation.

**§ 315.2. Review of an unpublished document.**

If the Commission finds that a published or unpublished document should be promulgated as a regulation, the Commission will present its finding to the Joint Committee on Documents. The Joint Committee on Documents shall determine whether the document should be promulgated as a regulation, and may order the agency to promulgate the document as a regulation within 180 days, or to desist from using the document in its business.

[Pa.B. Doc. No. 99-1048. Filed for public inspection July 2, 1999, 9:00 a.m.]

---

## Title 58—RECREATION

### FISH AND BOAT COMMISSION

[58 PA. CODE CH. 91]

[Correction]

#### Age of Operator

The document amending § 91.4 (relating to age of operator), which appeared at 29 Pa.B. 3213 (June 26, 1999), was printed with an incorrect heading referencing Lake Winola, Wyoming County. The head should have read "Age of Operator." The remaining text of the final rulemaking was accurate.

[Pa.B. Doc. No. 99-1011. Filed for public inspection June 25, 1999, 9:00 a.m.]

---

# PROPOSED RULEMAKING

## DEPARTMENT OF EDUCATION

[22 PA. CODE CH. 354]

### Institutional Preparation of Professional Educators

The Department of Education (Department) proposes to add Chapter 354 (relating to preparation of professional educators) under authority, delegated to the Department, by the State Board of Education (State Board) in § 49.13(a) (relating to policies). The Board's authority to promulgate Chapter 49 (relating to certification of professional personnel) is found in Article XII and sections 1109, 1141, 1201—1214, 2603-B and 2604-B of the Public School Code of 1949 (code) (24 P. S. §§ 11-1109, 11-1141, 12-1201—12-1214, 26-2603-B and 26-2604-B).

#### *Purpose*

The proposed Chapter 354 sets forth the basic rules for the preparation of professional educators in this Commonwealth. The proposed regulations are necessary to strengthen the preparation of professional educators who will serve in the public schools of this Commonwealth. It is in the interest of this Commonwealth's public schools that institutions preparing professional educators maintain the highest standards of academic excellence. Accordingly, to be authorized to conduct educator preparation programs in this Commonwealth, institutions and any of their off-campus centers shall meet the requirements in this proposed rulemaking.

Section 354.12 (relating to approval procedures) reaffirms the Department's authority to evaluate and deny or approve professional educator programs at institutions of higher education. This section also establishes a 5-year time interval for complete professional educator program reviews.

Section 354.13 (relating to standards) defines those categories of operation of professional educator preparation programs and establishes the standards for both initial and advanced professional educator preparation programs.

Section 354.23 (relating to unit reporting) requires certain reports to be submitted to the Department, applicants, current students and the State Board. Section 354.24 (relating to general studies) defines the minimum general studies requirements for candidates for professional educator certification.

Section 354.25 (relating to academic competence) outlines the requirements placed on professional educator candidates regarding academic competence in the discipline that candidates plan to teach or educational areas in which the candidate intends to serve. The section also defines the minimum grade point average (GPA) which candidates shall maintain and requires that general studies and studies in the academic disciplines shall be the same as for a Bachelor of Arts or Bachelor of Science degree with a major in these disciplines. Section 354.26 (relating to preparation program curriculum) requires the professional educator program to be designed to be efficient, avoid duplication or repetition of coursework and to enable candidates to integrate general and academic studies with professional and pedagogical knowledge.

Section 354.27 (relating to collaborative programs) defines the collaborative association that institutions with

approved professional educator programs shall establish. Subsection (c) requires teacher preparing institutions to provide ongoing support to novice educators in cooperation with public school entities during their induction period and subsection (d) requires cooperative efforts between teacher preparation programs and public school entities in the development and implementation of appropriate alternative certification programs. Section 354.31 (relating to admission) defines the criteria for admission to professional educator programs and establishes the required GPA for admission.

Section 354.32 (relating to monitoring and assessment) creates a systematic monitoring requirement based on performance assessment to measure competencies in several skills. Section 354.33 (relating to professional competency) requires development of a procedure to confirm a candidate's competence to begin the candidate's professional role prior to recommendation for professional educator certification.

Section 354.41 (relating to faculty quality) requires that faculty be teacher scholars and that the preparing institution establish a comprehensive plan to confirm activities to enhance and assess the intellectual vitality of the faculty.

#### *Affected Parties*

Persons who intend to pursue initial professional educator certification and teacher education personnel at the 89 colleges and universities which prepare teachers in this Commonwealth will be required to comply. Additionally, a college or university which has an approved teacher education program or seeks to offer an approved program will be required to comply.

#### *Cost and Paperwork Estimates*

Cost to the individual preparing for or holding educator license/certification:

Costs for the completion of academic requirements: ranging from \$40,000 to \$100,000 for a Baccalaureate Degree currently exist (unless under scholarship or financial aid).

Costs borne by institutions of higher education which offer teacher certification programs are inherent in the restructuring of programs to be in compliance with new standards.

There are no costs or savings, or both, to any local governmental authority.

The costs to State government would be related to the following: The development of new standards handbooks; training and evaluation manuals and guides; training sessions and workshops for evaluators, chairpersons and proposal writers from institutions preparing self-studies for accreditation. These expenditures will be from Department general operating funds, with an approximate cost of \$30,000 to \$50,000, spread over 3 years. Costs to maintain the program approval process would be comparable to already existing costs which have been approximately \$300,000 per year.

#### *Effective Date*

The proposed regulations will take effect upon publication as final rulemaking in the *Pennsylvania Bulletin*. An implementation schedule will be established to allow time for preparing institutions to adjust their programs to come into compliance.

*Sunset Date*

The effectiveness of Chapter 49 is reviewed by the State Board every 10 years. The proposed regulations will be reviewed concurrently with the decennial review of Chapter 49. Thus, no sunset date is necessary.

*Regulatory Review*

Under section 5(a) of the Regulatory Review Act (71 P.S. § 745.5(a)), on June 23, 1999, the Department submitted a copy of these proposed regulations to the Independent Regulatory Review Commission (IRRC) and to the Chairpersons of the House and Senate Committees on Education. In addition to submitting the proposed regulations, the Department has provided IRRC and the Committees with a copy of a detailed Regulatory Analysis Form prepared in compliance with Executive Order 1996-1, "Regulatory Review and Promulgation." A copy of these materials is available to the public upon request.

If the Committees have objections to any portion of the proposed regulations, they will notify the Department within 20 days of the close of the public comment period. If IRRC has objections to any portion of the proposed regulations, it will notify the Department within 10 days of the close of the Committees' comment period. The notification shall specify the regulatory review criteria which have not been met by that portion. The Regulatory Review Act specifies detailed procedures for review by the Department, the Governor and the General Assembly before publication of the regulations.

*Public Comments, Hearings and Contact Person*

*Public Comments:* Interested persons are invited to submit written comments, suggestions or objections regarding this proposal to Samuel G. Marcus, Higher Education Associate, Bureau of Teacher Preparation and Certification, 333 Market Street, Harrisburg, PA 17126-0333, within 30 days following publication in the *Pennsylvania Bulletin*.

*Hearings:* The Department has scheduled a series of three public hearings to receive testimony from interested parties regarding their views and recommendations on these proposed regulations.

The hearings will be held in the Harrisburg, Allentown and Indiana areas from 9 a.m. until 5 p.m. as follows:

July 14, 1999	Department of Education Heritage Room A 333 Market Street Harrisburg, PA 17126-0333
July 20, 1999	Carbon-Lehigh Intermediate Unit 21 Meeting Room 4750 Orchard Road Schnecksville, PA 18078-2597
July 27, 1999	Arin Intermediate Unit 28 Meeting Room 2895 Route 422 West Indiana, PA 15701-8300

Oral testimonies will be limited to 10 minutes. Twenty-five copies of written text of oral testimony are requested. Organizations are required to submit one combined testimony through a single witness and statement. Persons interested in appearing and presenting testimony on July 14, 20 or 27 should telephone the Division of Teacher Education at (717) 787-3470 by 4 p.m. July 8, 1999. Appearances will be scheduled on a first-come, first-served basis.

Persons unable to appear to present testimony are invited to submit written testimony which will be af-

forded the same consideration by the Department as oral testimony. Written testimony, along with 25 copies should be submitted to the Division of Teacher Education, 333 Market Street, Harrisburg, PA 17126-0333. Written testimony will not be accepted after 4 p.m. August 2, 1999.

Persons with a disability needing special accommodations to attend the hearings may contact Samuel Marcus at the previous address and telephone number at least 24 hours in advance so that arrangements can be made.

Alternative formats of this proposed rulemaking are available upon request. Persons needing additional information regarding this proposal may contact Samuel Marcus at (717) 787-3470. Persons with disabilities needing an alternative means of providing public comment may make arrangements by calling Samuel Marcus at (717) 787-3470 or TDD (717) 772-2864. Alternative formats of the proposed regulations (for example, braille, large print, cassette tape) can be made available to members of the public upon request to Samuel Marcus at the telephone and TDD numbers listed previously.

EUGENE W. HICKOK,  
*Secretary*

**Fiscal Note:** 6-264. (1) General Fund; (2) Implementing Year 1999-00 is \$10,000; (3) 1st Succeeding Year 2000-01 is \$10,000; 2nd Succeeding Year 2001-02 is \$10,000; 3rd Succeeding Year 2002-03 is \$0; 4th Succeeding Year 2003-04 is \$0; 5th Succeeding Year 2004-05 is \$0; (4) Fiscal Year 1998-99 \$200,000; Fiscal Year 1997-98 \$257,000; Fiscal Year 1996-97 \$362,000; (7) Department of Education—General Government Operations; (8) recommends adoption.

**Annex A****TITLE 22. EDUCATION****PART XVI. STANDARDS****CHAPTER 354. PREPARATION OF PROFESSIONAL EDUCATORS****GENERAL PROVISIONS**

Sec.	
354.1.	Definitions.
354.2.	Purpose.

**GENERAL**

354.11.	Minimum requirements for approval.
354.12.	Approval procedures.
354.13.	Standards.

**CATEGORY I—PROGRAM DESIGN**

354.21.	Mission.
354.22.	Field experience.
354.23.	Unit reporting.
354.24.	General studies.
354.25.	Academic competence.
354.26.	Preparation program curriculum.
354.27.	Collaborative programs.

**CATEGORY II—CANDIDATES**

354.31.	Admission.
354.32.	Monitoring and assessment.
354.33.	Professional competency.

**CATEGORY III—FACULTY**

354.41.	Faculty quality.
---------	------------------

**GENERAL PROVISIONS****§ 354.1. Definitions.**

The following words and terms, when used in this chapter, have the following meanings, unless the context clearly indicates otherwise:

*Act*—The Public School Code of 1949 (24 P.S. §§ 1-101—27-2702).

*Advanced preparation program*—A program at the post-baccalaureate level for those who already have completed an initial preparation program. Candidates in advanced preparation programs normally are seeking additional areas of certification or supervisor, administrative or educational specialist certification.

*Candidate*—An individual seeking admission to or who is enrolled in a program for the initial or advanced preparation of professional educators.

*Department*—The Department of Education of the Commonwealth.

*Educational institutions*—Public and private school organizations that provide instructional services including: public schools, intermediate units, vocational-technical schools, colleges and universities, as well as private sectarian and nonsectarian schools, colleges and universities.

*Educational specialty*—Areas of educational expertise other than instruction including: education specialists, supervisory and administrative personnel.

*Field experiences*—Programs that provide prospective professional educator candidates with opportunities, prior to student teaching, internship or clinical experiences to observe and participate in activities including: observing, tutoring, miniteaching, lesson planning and evaluating student performance, which may take place in a laboratory setting, in public schools or community organizations.

*General standards*—The overall standards that shall be met for an institution to be approved to conduct professional educator programs in this Commonwealth.

*General studies*—Coursework in the arts, communications, history, literature, mathematics, philosophy, sciences and the social sciences.

*Initial preparation program*—A program at the baccalaureate or postbaccalaureate level that prepares candidates for their first certification as a professional educator.

*Pennsylvania Academic Standards*—Standards for Commonwealth public schools, in Chapter 4 (relating to academic standards and assessment) as established by the State Board of Education, the achievement of which demonstrates the attainment of high levels of public school student competency.

*Preparing institution*—A college or university that has been approved by the Department to conduct professional educator preparation programs.

*Professional educator*—Teachers, educational specialists, supervisors and professional administrators employed in public schools in this Commonwealth.

*Professional educator courses*—Courses of study of theoretical and practical knowledge in:

(i) Humanistic and behavioral foundations of education, structure, function and purpose of educational institutions in our society.

(ii) Methods and materials of instruction appropriate to the elementary or secondary level, or both.

(iii) Directed practice of teaching in educational positions under institutional supervision at the level for which a certificate is granted.

*Specific professional educator program standards*—Department-defined competencies and course content for specific professional educator certification programs.

*Unit*—The department or other administrative unit within a preparing institution that is responsible for initial or advanced preparation of professional educators or the preparation of vocational instructional certificated personnel.

#### § 354.2. Purpose.

(a) Candidates for admission to a professional educator program and for a career in public schools in this Commonwealth shall have a proven record of high academic achievement, and their professional educator curriculum shall prepare them to master both the content and the teaching methodology of their discipline.

(b) In the interest of the students in public schools in this Commonwealth, institutions of higher education that prepare professional educators shall maintain the highest standards of academic excellence to receive and maintain Department approval to conduct programs leading to Commonwealth public school certification.

#### GENERAL

#### § 354.11. Minimum requirements for approval.

To be authorized to conduct preparation programs in this Commonwealth, institutions and their off-campus centers shall meet the following requirements:

(1) Be approved as a baccalaureate or graduate degree-granting, or both, institution by the Department.

(2) Be evaluated and approved by the Department to offer specific programs leading to professional educator certification in accordance with the general standards contained in this chapter and the specific professional educator program standards established by the Department.

#### § 354.12. Approval procedures.

(a) The Department may deny or withdraw approval from preparing institutions for failure to meet the requirements outlined in § 354.11 (relating to minimum requirements for approval) as defined in section 1109 of the act (24 P. S. § 11-1109).

(b) Prior to approval as a preparing institution, the Department will conduct an evaluation to ensure the requirements in this chapter are met. The Department may review approved preparation programs at any time. Regular evaluations of approved programs will be conducted at 5-year intervals.

(c) Evaluation teams will be appointed by the Department and consist of professional educators from basic education and appropriate personnel from institutions of higher education. Evaluation teams shall make recommendations to the Department regarding the approval or disapproval of programs.

(d) Preparing institutions shall apply to the Department for approval of new programs and all changes to previously approved programs. The application shall be made 90 days prior to the implementation of the planned changes. New programs and proposed changes to existing programs shall be consistent with relevant general standards contained in this chapter and specific professional educator program standards.

#### § 354.13. Standards.

The following standards shall be used to evaluate institutions seeking initial approval or maintaining approval to prepare professional educators for Commonwealth public school certification:

(1) Category I—Program Design.



- (2) Category II—Candidates.
- (3) Category III—Faculty.

#### CATEGORY I—PROGRAM DESIGN

##### § 354.21. Mission.

The unit shall have a clearly articulated mission and purpose that is based on the needs of professional educator candidates, public school students and educational institutions. The evidence required to satisfy that this standard is met includes:

- (1) The mission statement is cooperatively developed by faculty, candidates, and other members of the professional community and documented under this section.
- (2) The professional educator program demonstrates coherence between the unit's mission, the Pennsylvania Academic Standards, courses, field experiences, instruction, evaluation, required candidate competencies and is in compliance with this chapter.

##### § 354.22. Field experience.

- (a) The unit shall develop sequential and developmental field experiences that may begin as early as the initial semester of college enrollment.
- (b) The sequential and developmental field experiences shall be an integrated part of the professional education curriculum, and shall be consistent with the overall program design.

##### § 354.23. Unit reporting.

- (a) The unit shall submit biennially to the Department, a systematic evaluation, which includes information obtained through the following sources:
  - (1) Candidate assessment.
  - (2) Collection of data from candidates.
  - (3) Data from recent graduates.
  - (4) Other members of the professional community.
- (b) The unit shall demonstrate that the result of the systemic evaluation, as specified in subsection (a), fosters candidate achievement through the modification and improvement of the unit's overall program design.
- (c) The unit shall annually compile and make available to applicants, current students, the Department and the State Board of Education information concerning the placement of its graduates. This information shall include the following placement rates:
  - (1) Graduates in teaching, educational specialists and educational administration positions in this Commonwealth.
  - (2) Other states outside this Commonwealth.
  - (3) Other professions, to be categorized by type of employment.

##### § 354.24. General studies.

- (a) The unit shall have a planned and thorough procedure to confirm that candidates have met the requirements for academic achievement, college level general studies courses, experiences in the liberal arts and sciences, and have developed theoretical and practical knowledge prior to formal acceptance into a professional education program.
- (b) General studies shall include the following:
  - (1) At least 6 semester hour credits (or the equivalent) in college level mathematics.

- (2) At least 6 semester hour credits (or the equivalent) in college level English composition and literature.

##### § 354.25. Academic competence.

(a) The unit shall have a planned thorough procedure to confirm that professional educator candidates maintain academic competence in the academic disciplines that the candidates plan to teach or in the academic disciplines related to the educational specialities in which they plan to serve. This standard shall be met by using the following criteria:

- (1) Candidates complete a sequence of courses or experiences, or both, to develop an understanding of the structure, skills, core concepts, ideas, values, facts, methods of inquiry, and uses of technology related to each academic discipline the candidates plan to teach or in the academic disciplines related to the educational specialities in which they plan to serve.
- (2) Pennsylvania Academic Standards and specific professional educator program standards are used in developing programs in each academic area.
- (3) Candidates whose preparation program culminates in a bachelor's degree or higher shall maintain a minimum grade point average in each academic discipline the candidate plans to teach or in the academic disciplines related to the educational specialities in which the candidate plans to serve, as follows:

(i) Academic Year: (first year after \_\_\_\_\_ (*Editor's Note: The blank refers to the effective date of adoption of this proposal.*) 2.6 GPA.

(ii) Academic Year: (second year after \_\_\_\_\_ (*Editor's Note: The blank refers to the effective date of adoption of this proposal.*) 2.8 GPA.

(iii) Academic Year: (third year after \_\_\_\_\_ (*Editor's Note: The blank refers to the effective date of adoption of this proposal.*) 3.0 GPA.

(iv) Future Academic Years: 3.0 GPA.

(b) For preparation programs culminating in a bachelor's degree or higher, general studies courses under § 354.24 (relating to general studies) shall be the same as for a Bachelor of Arts or Bachelor of Science degree.

(c) For preparation programs culminating in a bachelor's degree or higher, academic content area courses for the preparation of professional educators shall include all required core courses and required elective courses in the Bachelor of Arts or Bachelor of Science major academic area the candidate intends to teach. Free electives in the Bachelor of Arts and Bachelor of Science major and credits in the cognate areas shall be optional.

(d) For preparation programs culminating in a bachelor's degree or higher, candidates for certification in more than one area shall meet the requirements in subsection (c) in the major area and for each additional area that the candidate plans to serve.

##### § 354.26. Preparation program curriculum.

(a) The preparation program shall be designed to ensure that professional educator candidates acquire and learn to apply the professional and pedagogical knowledge and skills needed to ensure that all students learn. The evidence required to demonstrate that this standard is met includes the following:

- (1) The preparation program design shall be consistent with the unit's mission, reflect knowledge derived from research and sound professional practice and be of high quality.

(2) The unit shall ensure that the preparation program curriculum does not include unnecessary duplication or repetition of course work and at all times strives to create efficient professional preparation.

(3) Candidates shall complete a well-planned and efficient sequence of courses or experiences, or both, in professional studies and pedagogical studies.

(4) The unit shall cooperate with the liberal arts and other academic disciplines of the college or university to create thorough and efficient preparation programs that allow the individual pursuing an initial area of certification requiring a degree to complete the degree within 4 years from the time of initial enrollment at the college or university.

(b) The preparation program developed by the unit shall be designed to enable candidates to integrate general and academic studies, with professional and pedagogical knowledge to teach, guide and assist public school students in achieving the Pennsylvania Academic Standards.

(c) The preparation program developed by the unit shall be designed to ensure that candidates become competent teachers or professional educators. Demonstration of this standard includes the following:

(1) Programs for the continuing preparation of teachers or other professional school personnel build upon and extend prior knowledge and experiences of students including core studies of learning and practices that support learning.

(2) Pennsylvania Academic Standards and specific professional educator program standards are used in developing programs in each academic area.

(3) Programs are designed to ensure students develop the ability to research information, use research methods, and acquire knowledge about issues and trends in public education to improve practice in schools and classrooms.

(d) The unit shall develop field experiences that are consistent with the unit's mission, as specified in § 354.21 (relating to mission). The evidence required to demonstrate that this standard is met includes the following:

(1) The unit shall develop field experiences, student teaching, internships and clinical experiences which provide candidates with an opportunity to do the following:

(i) Apply principles and theories from the program design to actual practice in classrooms and schools.

(ii) Create meaningful learning experiences for all students.

(iii) Study and practice in a variety of communities, with students of different ages, and with culturally diverse and exceptional populations.

(2) Field experiences shall:

(i) Be fully supported by unit faculty.

(ii) Include frequent observation and consultation with supervising teachers and public school administrators trained in the institution's education philosophy.

(iii) Encourage reflection by candidates.

(iv) Include evaluation and feedback from higher education faculty, public school faculty and peers.

(3) Field experiences, which shall begin by the first semester of enrollment in an initial or advanced preparation program, shall be sufficiently extensive and intensive

for candidates to demonstrate competence in the professional roles for which they are preparing.

(4) A minimum of 12 weeks of full-time student teaching, or its equivalent, is required.

#### § 354.27. Collaborative programs.

(a) The unit shall collaborate with higher education faculty, public school personnel, and other members of the professional education community to design, deliver, and facilitate effective programs for the preparation of professional educators and to improve the quality of education in schools. The evidence required to demonstrate that this standard is met includes:

(1) Faculty who teach general and academic studies, professional and pedagogical studies shall regularly collaborate in program planning and evaluation of all facets of the curriculum.

(2) The unit shall develop agreements with public schools and cooperating professionals to ensure:

(i) Student teaching, internships and other field experiences are collaboratively designed and implemented.

(ii) Candidates are supported in their achievement of the desired learning goals.

(iii) Cooperating teachers are trained by the unit to assist, guide and evaluate the performance of student teachers and individuals who are serving in a clinical experience or internship.

(b) The unit shall develop collaborative relationships, programs, and projects with prekindergarten to grade 12 public schools, their faculties, and other appropriate public school personnel to develop and refine knowledge bases, to conduct research and to improve the quality of education.

(c) The unit shall provide ongoing support to novice educators in partnership with public schools during their induction period, including observation, consultation and assistance.

(d) The unit shall cooperate with local school entities in the development and implementation of appropriate alternative certification programs.

### CATEGORY II—CANDIDATES

#### § 354.31. Admission.

There shall be documentation that the unit recruits, admits and retains candidates who demonstrate potential for professional success in public schools. The evidence required to demonstrate that this standard is met includes:

(1) A comprehensive system to assess the qualifications of candidates seeking admission.

(2) A candidate whose preparation program culminates in a bachelor's degree or higher may not be formally admitted to initial professional educator preparation programs before completion of three semesters of full-time (48 credits) or full-time equivalent college level study.

(3) The criteria for admission to teacher preparation programs are based on multiple sources of data which include:

(i) An assessment of academic proficiency.

(ii) College entrance examinations.

(iii) Faculty recommendations.

(iv) Biographical information.

(4) A candidate admitted to initial teacher preparation programs and whose preparation program culminates in a bachelor's degree or higher shall complete prior college or university coursework, exclusive of professional education courses, with a minimum grade point average (GPA) as follows:

(i) Academic Year: (first year after \_\_\_\_\_ (*Editor's Note: The blank refers to the effective date of adoption of this proposal.*) 2.6 GPA.

(ii) Academic Year: (second year after \_\_\_\_\_ (*Editor's Note: The blank refers to the effective date of adoption of this proposal.*) 2.8 GPA.

(iii) Academic Year: (third year after \_\_\_\_\_ (*Editor's Note: The blank refers to the effective date of adoption of this proposal.*) 3.0 GPA.

(iv) Future Academic Years: 3.0 GPA.

(v) As an alternative to the 3.0 GPA admissions standard, candidates may be admitted if they have achieved a 2.8 GPA and qualifying scores on the Praxis I, Pre-Professional Skills Test of 178 in Mathematics, 178 in Reading and 174 in Writing.

(5) The preparation program may accept up to 10% of candidates for admission to the program who do not meet the minimum GPA, including the phase-in years defined in paragraph (4), if exceptional circumstances justify admission.

(6) The criteria for admission to advanced programs shall include at least the following:

(i) An assessment of academic proficiency—for example, the Miller Analogy Test (MAT), Graduate Record Exam (GRE).

(ii) A minimum of 3.0 GPA.

(iii) Faculty and professional recommendations.

(iv) Record of competence and effectiveness in professional work.

(v) Graduation from a regionally accredited college or university.

(7) The advanced preparation program may accept up to 10% of candidates for admission to the program who do not meet the minimum criteria in paragraph (6), if exceptional circumstances justify admission.

(8) The unit shall develop admission procedures for postbaccalaureate initial and advanced professional educator preparation programs to confirm that the following indicators are met:

(i) That candidates have attained appropriate depth and breadth in both general and academic studies under §§ 354.24—354.26 (relating to general studies; academic competence; and preparation program curriculum).

(ii) Incentives and affirmative procedures attract candidates with high academic and other qualifications.

(iii) Admission decisions are monitored by the unit to ensure that the admissions criteria are applied.

(iv) The unit seeks to recruit, admit and retain a diverse student body.

#### § 354.32. Monitoring and assessment.

(a) The unit shall develop a program that systematizes and monitors and assesses the progress of candidates and confirms that they receive appropriate academic and professional counseling and advice from the time of admission through completion of their professional education program.

The evidence required to demonstrate that this standard is met includes at least the following:

(1) The progress of candidates at different stages of the program shall be monitored through performance-based assessments which shall stipulate the level of competence required to ensure success in the following skill dimensions:

(i) Content mastery.

(ii) Planning.

(iii) Classroom management.

(iv) Organization.

(v) Monitoring student progress.

(vi) Leadership.

(vii) Sensitivity to students' needs.

(viii) Problem analysis.

(ix) Strategic and tactical decision making.

(x) Oral and written communication and presentation.

(xi) Innovativeness.

(xii) Personal interactions.

(xiii) Tolerance for stress.

(xiv) Professional standards and practice.

(2) Assessment of candidates' progress shall be based on multiple data sources that include at least the following:

(i) Grade point average.

(ii) Observations of field experience, student teaching, internship and clinical experience performance.

(iii) The use of various instructional strategies and technologies.

(iv) Faculty recommendations.

(v) Demonstrated competence in academic and professional work (for example, portfolios, performance assessments, research and concept papers).

(vi) Recommendations from appropriate professionals such as cooperating teachers and supervisors in pre-K through 12.

(b) Assessment data, as defined in subsection (a)(2), shall be used to advise candidates in future career planning.

(c) Criteria consistent with the purpose and mission of the professional educator program shall be used to determine eligibility for student teaching and other professional internships.

(d) The unit shall, through publications and faculty advisement, provide candidates with clear information about institutional policies and requirements needed for:

(1) Completing their professional education programs.

(2) Satisfying State certification requirements under Chapter 49 (relating to certification of professional personnel).

(3) Obtaining social and psychological counseling services.

(4) Exploring job opportunities.

#### § 354.33. Professional competency.

The unit shall develop a procedure to confirm that a candidate's competency to begin the candidate's professional role in schools is assessed prior to completion of

the program and recommendation for professional educator certification. The evidence required to demonstrate that this standard is met includes:

- (1) The unit shall establish and publish a set of criteria and competencies for exit from each professional education program, which are based on the Pennsylvania Academic Standards and specific professional educator program standards.
- (2) The unit shall establish a procedure to confirm that a candidate's mastery of a program's stated exit criteria and competencies is assessed through the use of multiple sources of data such as: a culminating experience, portfolios, interviews and observed performances in public schools, standardized tests, and course grades.
- (3) The assessment shall include input from professionals serving in prekindergarten through grade 12.
- (4) Candidates in programs culminating in a bachelor's degree or higher shall complete the program with a minimum GPA of 3.0 in professional education studies and in the academic discipline the candidates plan to teach or in the academic discipline related to the educational specialty in which they plan to serve.
- (5) An acceptable percentage of candidates, as determined by the Secretary of the Department and the State Board of Education, shall achieve at a satisfactory level on Commonwealth standardized performance assessments required for certification under Chapter 49 (relating to certification of professional personnel).

**CATEGORY III—FACULTY**

**§ 354.41. Faculty quality.**

- (a) The unit shall establish a procedure to confirm that the professional education faculty are education scholars who are qualified for their assignments and actively engaged in the professional education community.
- (b) The unit shall provide documentation to confirm that the unit seeks to recruit, hire and retain a diverse faculty.
- (c) The unit shall establish a comprehensive plan to confirm that there are systematic and comprehensive activities to enhance and assess the competence and intellectual vitality of the faculty.

[Pa.B. Doc. No. 99-1049. Filed for public inspection July 2, 1999, 9:00 a.m.]

**FISH AND BOAT COMMISSION**

**[58 PA. CODE CH. 69]  
Lake Erie Fishing Permit**

The Fish and Boat Commission (Commission) proposes to amend Chapter 69 (relating to fishing in Lake Erie and boundary lakes). The Commission is publishing this amendment as a notice of proposed rulemaking under the authority of 30 Pa.C.S. (relating to the Fish and Boat Code) (code). The proposed amendment relates to fishing.

**A. Effective Date**

The proposed amendment, if approved on final rulemaking, will go into effect upon publication of an order adopting the amendment in the *Pennsylvania Bulletin*.

**B. Contact Person**

For further information on the proposed change, contact Laurie E. Shepler, Assistant Counsel, (717) 657-4546, P. O. Box 67000, Harrisburg, PA 17106-7000. This proposal is available electronically through the Commission's Web site (<http://www.fish.state.pa.us>).

**C. Statutory Authority**

The proposed amendment is published under the statutory authority of section 2907.2(d) of the code (relating to Lake Erie fishing permits).

**D. Purpose and Background**

The proposed amendment is designed to update, modify and improve Commission regulations relating to fishing. The specific purpose of the amendment is described in more detail under the summary of proposal.

**E. Summary of Proposal**

The Commission has reached its financial goal of recompensing the holders of gill net licenses for boundary lakes as provided in section 2903(h) of the code (relating to boats and net licenses for boundary lakes, gill nets). As a result, anglers are no longer required to purchase a Lake Erie fishing permit effective January 1, 1999. Therefore, there is no need for the existing regulation relating to the Lake Erie fishing permit, and the regulation should be removed.

**F. Paperwork**

The proposed amendment will not increase paperwork and will create no new paperwork requirements.

**G. Fiscal Impact**

The proposed amendment will have no adverse fiscal impact on the Commonwealth or its political subdivisions. The proposed amendment will impose no new costs on the private sector or the general public.

**H. Public Comments**

Interested persons are invited to submit written comments, objections or suggestions about the proposed amendment to the Executive Director, Fish and Boat Commission, P. O. Box 67000, Harrisburg, PA 17106-7000, within 30 days after publication of this proposal in the *Pennsylvania Bulletin*. Comments submitted by facsimile will not be accepted.

Comments also may be submitted electronically at "regulations@fish.state.pa.us." A subject heading of the proposal and a return name and address must be included in each transmission. In addition, all electronic comments must be contained in the text of the transmission, not in an attachment. If an acknowledgment of electronic comments is not received by the sender within 2 working days, the comments should be retransmitted to ensure receipt.

PETER A. COLANGELO,  
*Executive Director*

**Fiscal Note:** 48A-98. No fiscal impact; (8) recommends adoption.

**Annex A**

**TITLE 58. RECREATION**

**PART II. FISH AND BOAT COMMISSION**

**Subpart B. FISHING**

**CHAPTER 69. FISHING IN LAKE ERIE AND BOUNDARY LAKES**

§ 69.18. [ Lake Erie fishing permit ] (Reserved).

[ (a) *Form.* The Lake Erie fishing permit required by section 2907.2 of the code (relating to Lake Erie fishing permits) shall be issued in the form of a stamp or a sticker.

(b) *Possession and display.* Lake Erie fishing permits shall be permanently affixed to the fishing license at the designated location and displayed with the fishing license. It is unlawful for a person required by section 2907.2 of the code to procure a Lake Erie fishing permit to fish in the Pennsylvania waters of Lake Erie, Presque Isle Bay or their tributaries unless the person has the Lake Erie fishing permit in possession while fishing and displays it in the manner described in this section. ]

[Pa.B. Doc. No. 99-1050. Filed for public inspection July 2, 1999, 9:00 a.m.]

### [58 PA. CODE CHS. 111 AND 115]

#### Special Regulations Counties and Boats Carrying Passengers for Hire

The Fish and Boat Commission (Commission) proposes to amend Chapters 111 and 115 (relating to special regulations counties; and boats carrying passengers for hire). The Commission is publishing these amendments as a notice of proposed rulemaking under the authority of 30 Pa.C.S. (relating to the Fish and Boat Code) (code). The proposed amendments relate to boating.

##### A. *Effective Date*

The proposed amendments, if approved on final rulemaking, will go into effect on January 1, 2000, or upon publication of an order in the *Pennsylvania Bulletin*, whichever occurs later.

##### B. *Contact Person*

For further information on the proposed changes, contact John F. Simmons, Director, Bureau of Boating and Education, (717) 657-4538, or Laurie E. Shepler, Assistant Counsel, (717) 657-4546, P. O. Box 67000, Harrisburg, PA 17106-7000. This proposal is available electronically through the Commission's Web site (<http://www.fish.state.pa.us>).

##### C. *Statutory Authority*

The proposed amendments are published under the statutory authority of sections 5122(a)(6) and 5124 of the code (relating to registration, licenses, permits, plates and statistics; and particular areas of water).

##### D. *Purpose and Background*

The proposed amendments are designed to update, modify and improve Commission regulations pertaining to boating. The specific purpose of the proposed amendments is described in more detail under the summary of proposal. Prior to consideration by the Commission, the Commission's Boating Advisory Board reviewed each proposal and made recommendations to the Commission.

##### E. *Summary of Proposal*

(1) *Section 111.9 (relating to Bucks County).* In 1995, the Commission approved the adoption of slow, minimum height swell speed zones under certain bridge spans over the Delaware River in Bucks County. This proposed change will make the Commonwealth's regulations consistent with Statewide regulations concerning the operation

of boats under bridge spans in New Jersey. The Commission now believes that it is appropriate to amend its regulations to include additional bridge spans between this Commonwealth and New Jersey.

(2) *Section 111.36 (relating to Lancaster County).* In June 1997, the Lancaster Bird Club petitioned the Commission for further regulation of boating on the Susquehanna River in the area between the Washington Boro Islands (Conejohola Flats) and the Lancaster County shoreline. The primary purpose of this request was to protect the shorebird and other migratory bird populations that frequent this area, as well as to provide a safe haven for unpowered boat users. The area affected is approximately 1/2 mile long and 300 yards wide. It is shallow over much of its length and contains numerous snags and other underwater obstructions. The area is also used routinely by personal watercraft operators. The Commission has approved the publication of a notice of proposed rulemaking containing the changes set forth in Annex A.

(3) *Section 111.46 (relating to Montgomery County).* The National Park Service (NPS) has initiated a Nationwide review of personal watercraft operations on waters within its jurisdiction. On those areas where personal watercraft use is nonexistent or minimal, the Director ordered an immediate prohibition. The Schuylkill River flows through the Valley Forge National Park for a distance of about 1 mile. The Betzwood Access, operated by the Park, currently provides access to this pool for boating and fishing. Because of the shallowness of the water and narrowness of the water course, boating use has been minimal in recent years, although an estimated 24 personal watercraft use the access to launch. According to the Park Superintendent, the operation of personal watercraft is inconsistent with the management goals of the Park, and in August 1998, he prohibited the launching of personal watercrafts from the access and the operation of personal watercrafts within the Park's boundaries.

Subsequent to this action, the Park Superintendent wrote to the Commission requesting consideration of concurrent regulations as well as the establishment of a Slow No Wake zone through the Park. Commission staff met with staff of the Valley Forge National Park and agreed that a Slow No Wake zone was an appropriate management tool for this area.

The Commission has approved the publication of a notice of proposed rulemaking to seek public comment on the establishment of a slow, minimum height swell speed zone on the Schuylkill River from the Route 422 Bridge to Pawling's Road Bridge. This proposed amendment will allow the Commission to help the Park Service reach its management goal without a specific ban on personal watercraft. It will also create an environment for nonpowered craft that is in keeping with the historical significance of the Valley Forge National Park.

(4) *Sections 111.52 and 111.64 (relating to Pike County; and Wayne County).* The NPS has broad authority to establish regulations on lands and waters within its jurisdiction. 36 CFR 1.1 (relating to purpose) states that units of the NPS may use their regulatory authority to fulfill the statutory purposes of units of the National Park System to conserve scenery, natural and historic objects, and wildlife and to provide for the enjoyment of those resources in a manner that will leave them unimpaired for the enjoyment of future generations. Using this authority and that in the specific enabling legislation that created the Upper Delaware National Recreational and Scenic River, the Superintendent promulgated several regulations in 1991 restricting the operation of boats on

the Delaware River. Because enforcement is a joint effort between the Commission and the NPS, the Commission believes that the regulations should be consistent. The Commission therefore proposes to amend these sections.

(5) Sections 115.9 and 115.10 (relating to licenses for operators; and renewal of operator's license). Section 115.9(f) provides that operator certificates issued under this section expire on December 31 of the year for which they are issued, and § 115.10(a) requires operators to renew their licenses by April 1. Over the past years, it has become apparent that owners of passenger for hire vessels have difficulty getting renewal applications with two photos required by § 115.9(e) for all their prospective employees and still meet the April 1 deadline. This is mostly due to the owner hiring students and other part-time employees that are employed beginning mid-June or later. Commission staff also have experienced difficulty in processing an average of 100 certificates (each year) back to the employer in a reasonable time. Again, this is due to late submissions, placing photos on both the certificates and applications, obtaining appropriate signatures and available staff time. The Commission believes that the proposed 5-year certificate will reduce processing time and the employer will have less difficulty staffing his operations prior to the start of the season. Currently, operators renew licenses annually with no more than their signature. No additional requirements are required by the Commission for renewal. The Commission believes that the annual renewal is an unnecessary paperwork burden on this small business and that a 5-year certificate would meet the Commission's needs. Accordingly, the Commission proposes to amend these sections to provide for a 5-year certificate.

F. Paperwork

The proposed amendments will not increase paperwork and will create no new paperwork requirements.

G. Fiscal Impact

The proposed amendments will have no adverse fiscal impact on the Commonwealth or its political subdivisions. The proposed amendments will impose no new costs on the private sector or the general public.

H. Public Comments

Interested persons are invited to submit written comments, objections or suggestions about the proposed amendments to the Executive Director, Fish and Boat Commission, P. O. Box 67000, Harrisburg, PA 17106-7000, within 30 days after publication of this notice in the Pennsylvania Bulletin. Comments submitted by facsimile will not be accepted.

Comments also may be submitted electronically at "regulations@fish.state.pa.us." A subject heading of the proposal and a return name and address must be included in each transmission. In addition, all electronic comments must be contained in the text of the transmission, not in an attachment. If an acknowledgment of electronic comments is not received by the sender within 2 working days, the comments should be retransmitted to ensure receipt.

PETER A. COLANGELO,
Executive Director

Fiscal Note: 48A-97. No fiscal impact; (8) recommends adoption.

Annex A
TITLE 58. RECREATION
PART II. FISH AND BOAT COMMISSION
Subpart C. BOATING
CHAPTER 111. SPECIAL REGULATIONS
COUNTIES

§ 111.9. Bucks County.

\* \* \* \* \*

(e) Delaware River.

\* \* \* \* \*

(2) Boats are limited to slow minimum height swell speed while passing through the following bridge spans:

\* \* \* \* \*

(iv) Lumberville Foot Bridge.

(v) Upper Black Eddy—Milford Bridge.

(vi) Riegelsville Bridge.

(vii) Frenchtown "Free" Bridge.

\* \* \* \* \*

§ 111.36. Lancaster County.

\* \* \* \* \*

(c) Susquehanna River: Boats are limited to slow, minimum height swell speed:

(1) From the Lancaster County shoreline to the northern point of Shad Island south to the southern point of Green Island and back to the Lancaster County shoreline from January 1 to October 1.

(2) In all areas between and within 200 feet of the islands comprising the Conejohola Flats.

§ 111.46. Montgomery County.

Schuylkill River: Boats are limited to slow, minimum height swell speed between:

(1) Barbadoes Island and the Norristown shore from the Barbadoes Island Bridge downriver to the Norristown Dam.

(2) The Route 422 Bridge and the Pawling's Road Bridge.

§ 111.52. Pike County.

\* \* \* \* \*

(j) Delaware River: The operation of personal watercraft is prohibited in the following areas within the Upper Delaware Scenic and Recreational River:

(1) From the southern terminus of the Park (mile 258.4) to the lower end of Pond Eddy Pool (mile 265).

(2) From the upper end of Pond Eddy Pool (mile 266.5) to the lower end of the Lackawaxen Pool (mile 277.7).

(3) From the upper end of Lackawaxen Pool (mile 278.7) to the lower end of Narrowsburg Pool (mile 289.5).

§ 111.64. Wayne County.

\* \* \* \* \*

(j) Delaware River: The operation of personal watercraft is prohibited in the following areas within the Upper Delaware Scenic and Recreational River:

(1) From the upper end of Narrowsburg Pool (mile 290.5) to the lower end of Long Eddy Pool (mile 315).

(2) From the upper end of Long Eddy Pool (mile 317) to the upper terminus of the Park (mile 330.7).

**CHAPTER 115. BOATS CARRYING PASSENGERS FOR HIRE**

**§ 115.9. Licenses for operators.**

\* \* \* \* \*

(f) *Expiration.* Operator certificates issued under this section will expire on December 31 [of the year for which they are issued] 5 years from the date of issuance.

**§ 115.10. Renewal of operator's license.**

(a) [ By April 1, the operator shall apply for renewal on the form provided by the Commission. The application shall be accompanied by payment of the fee specified by law. ] Operators may apply for a renewal of their licence 60 days prior to its expiration. Applications shall be made on the form provided by the Commission and accompanied by the appropriate fees.

\* \* \* \* \*

[Pa.B. Doc. No. 99-1051. Filed for public inspection July 2, 1999, 9:00 a.m.]

\_\_\_\_\_

# NOTICES

## DEPARTMENT OF BANKING

### Action on Applications

The Department of Banking of the Commonwealth of Pennsylvania, under the authority contained in the act of November 30, 1965 (P. L. 847, No. 356), known as the Banking Code of 1965; the act of December 14, 1967 (P. L. 746, No. 345), known as the Savings Association Code of 1967; the act of May 15, 1933 (P. L. 565, No. 111), known as the Department of Banking Code; and the act of December 19, 1990 (P. L. 834, No. 198), known as the Credit Union Code, has taken the following action on applications received for the week ending June 22, 1999.

#### BANKING INSTITUTIONS

##### Holding Company Acquisitions

<i>Date</i>	<i>Name of Corporation</i>	<i>Location</i>	<i>Action</i>
6-15-99	Summit Bancorp, Princeton, New Jersey, and First Valley Corporation, Bethlehem, PA, to acquire 100% of the voting shares of Prime Bancorp, Inc., Fort Washington, PA	Princeton, NJ	Approved

##### New Charter Applications

<i>Date</i>	<i>Name of Bank</i>	<i>Location</i>	<i>Action</i>
6-18-99	Northeast Pennsylvania Trust Company Hazleton Luzerne County	2 East Broad Street Hazleton Luzerne County	Approved

##### Consolidations, Mergers and Absorptions

<i>Date</i>	<i>Name of Bank</i>	<i>Location</i>	<i>Action</i>
6-15-99	United Bank of Philadelphia Philadelphia Philadelphia County  Purchase of assets/assumption of liabilities of three branch offices of First Union National Bank, Charlotte, NC, located at:  1620 Wadsworth Avenue Philadelphia Philadelphia County  2836 West Girard Avenue Philadelphia Philadelphia County  Summit Bank, Bethlehem, and Prime Bank, Philadelphia Surviving Institution—Summit Bank, Bethlehem	Philadelphia         3945-49 Chestnut Street Philadelphia Philadelphia County    Bethlehem	Filed         Approved
6-18-99	Northwest Savings Bank Warren Warren County  Purchase of assets/assumption of liabilities of eight branch offices of PNC Bank, N.A., Pittsburgh, located at:  475 Theatre Drive Johnstown Cambria County Lyter Drive & Entrance Way Johnstown Cambria County  225-227 Franklin Street Johnstown Cambria County	Warren         Walnut & West Spruce Street Marienville Forest County 428 Main Street Smethport McKean County  5 Buckingham Street Tidioute Warren County	Filed



<i>Date</i>	<i>Name of Bank</i>	<i>Location</i>	<i>Action</i>
6-18-99	221 Elm Street Tionesta Forest County The Peoples State Bank East Berlin Adams County Purchase of assets/assumption of liabilities of one branch office of Sovereign Bank, FSB, Wyomissing, located at: 29 North Washington Street Gettysburg Adams County	101 South Main Street Sheffield Warren County East Berlin	Filed

**Interstate Branch Applications**

<i>Date</i>	<i>Name of Bank</i>	<i>Location</i>	<i>Article</i>
6-17-99	U.S. Trust Company of Connecticut Greenwich Connecticut	100 W. Lancaster Ave. Wayne Delaware County Pennsylvania	Approved

**Branch Applications**

<i>Date</i>	<i>Name of Bank</i>	<i>Location</i>	<i>Action</i>
10-1-98	Fidelity Savings Bank Pittsburgh Allegheny County	2034 Penn Avenue Pittsburgh Allegheny County	Opened
6-15-99	Main Street Bank Reading Berks County	1701 Chew Street Allentown Lehigh County	Opened
6-16-99	FirstService Bank Lansdale Montgomery County	301 Oxford Valley Rd. Yardley Bucks County	Approved
6-16-99	The Drovers & Mechanics Bank York York County	Northeast Quadrant of Pine Rd. & Route 382 Newberry Township York County	Approved
6-17-99	Prime Bank Philadelphia Philadelphia County	12 Chestnut Road Paoli Chester County	Authorization Surrendered
6-17-99	Prime Bank Philadelphia Philadelphia County	473 York Road Warminster Bucks County	Authorization Surrendered
6-17-99	Prime Bank Philadelphia Philadelphia County	1430 Walnut Street Philadelphia Philadelphia County	Authorization Surrendered
6-17-99	Summit Bank Bethlehem Northampton County	473 York Road Warminster Bucks County	Filed
6-17-99	Summit Bank Bethlehem Northampton County	1430 Walnut Street Philadelphia Philadelphia County	Filed
6-18-99	Prime Bank Philadelphia Philadelphia County	1235 West Chester Pike Havertown Delaware County	Authorization Surrendered
6-19-99	Main Street Bank Reading Berks County	235 Main Street Emmaus Lehigh County	Opened
6-19-99	Main Street Bank Reading Berks County	225 West Lancaster Ave. Ardmore Montgomery County	Opened

<i>Date</i>	<i>Name of Bank</i>	<i>Location</i>	<i>Action</i>
6-21-99	First Heritage Bank Wilkes-Barre Luzerne County	R. D. #1 Airport Beltway Hazleton Luzerne County	Filed

**Branch Relocations**

<i>Date</i>	<i>Name of Bank</i>	<i>Location</i>	<i>Action</i>
6-17-99	Summit Bank Bethlehem Northampton County	<i>To:</i> 12 Chestnut Road Paoli Chester County  <i>From:</i> 1756 East Lancaster Avenue Paoli Chester County	Filed

**Branch Discontinuances**

<i>Date</i>	<i>Name of Bank</i>	<i>Location</i>	<i>Action</i>
6-8-99	Laurel Trust Company Johnstown Cambria County	101 Ligonier Street Latrobe Westmoreland County	Filed
6-8-99	Laurel Trust Company Johnstown Cambria County	922 Philadelphia St. Indiana Indiana County	Filed
6-16-99	Summit Bank Bethlehem Northampton County	Second Avenue and Hutchison Street Martins Creek Northampton County	Approved

**Articles of Amendment**

<i>Date</i>	<i>Name of Bank</i>	<i>Purpose</i>	<i>Action</i>
6-17-99	Hometowne Heritage Bank Intercourse Lancaster County	To amend Article Six of the Articles of Incorporation to provide for the restatement of the organizers' subscription for common stock.	Approved and Effective

**SAVINGS ASSOCIATIONS**

No activity.

**CREDIT UNIONS**

No activity.

DAVID E. ZUERN,  
*Secretary*

[Pa.B. Doc. No. 99-1052. Filed for public inspection July 2, 1999, 9:00 a.m.]

**DEPARTMENT OF ENVIRONMENTAL PROTECTION****Applications, Actions and Special Notices****APPLICATIONS****APPLICATIONS RECEIVED UNDER THE PENNSYLVANIA CLEAN STREAMS  
LAW AND THE FEDERAL CLEAN WATER ACT****[National Pollution Discharge Elimination System Program (NPDES)]****DISCHARGE OF CONTROLLED INDUSTRIAL WASTE AND SEWERAGE WASTEWATER****(Part I Permits)**

The following parties have applied for an NPDES permit to discharge controlled wastewaters into the surface waters of this Commonwealth. Unless otherwise indicated on the basis of preliminary review and application of lawful standards and regulations the Department of Environmental Protection (Department) proposes to issue a permit to discharge subject to certain effluent limitations and special conditions. These proposed determinations are tentative.

Where indicated, the EPA Region III Administrator has waived the right to review or object to this proposed permit action under the waiver provision 40 CFR 123.6E.

Persons wishing to comment on the proposed permit are invited to submit a statement to the office noted above the application within 30 days from the date of this public notice. Comments received within this 30-day comment period will be considered in the formulation of the final determinations regarding this application. Responses should include the name, address and telephone number of the writer and a concise statement to inform the Department of the exact basis of a comment and the relevant facts upon which it is based. A public hearing may be held if the responsible office considers the public response significant.

Following the 30-day comment period, the Water Management Program Manager will make a final determination regarding the proposed permit. Notice of this determination will be published in the *Pennsylvania Bulletin* at which time this determination may be appealed to the Environmental Hearing Board.

The application and related documents, proposed effluent limitations and special conditions, comments received and other information are on file and may be inspected and arrangements made for copying at the office indicated above the application.

Persons with a disability who wish to attend the hearing and require an auxiliary aid service or other accommodations to participate in the proceeding should contact the Secretary to the Board at (717) 787-3483. TDD users may contact the Department through the Pennsylvania AT&T Relay Service at (800) 654-5984.

---

**Applications for National Pollutant Discharge Elimination System (NPDES) permit to discharge to State waters.**

---

*Southeast Regional Office: Regional Manager, Water Management, Lee Park, Suite 6010, 555 North Lane, Conshohocken, PA 19428, (610) 832-6130.*

**PA 0036234.** Industrial waste, **UNOCAL**, 2300 Barrington Road, Hoffman Estates, IL 60195.

This application is for renewal of an NPDES permit to discharge treated groundwater from a groundwater remediation system in Conshohocken Borough, **Montgomery County**. This is an existing discharge to Plymouth Creek.

The receiving stream is classified for the following uses: warm water fishery, aquatic life, water supply and recreation.

The proposed effluent limits for Outfall 002, based on an average flow of 0.025 mgd, are as follows:

<i>Parameter</i>	<i>Average Monthly (mg/l)</i>	<i>Maximum Daily (mg/l)</i>	<i>Instantaneous Maximum (mg/l)</i>
Benzene	0.005	0.010	0.0125
Ethylbenzene	0.10	0.20	0.25
Toluene	0.4	0.8	1.0
1,1,1 Trichloroethane	0.2	0.4	0.5
Vinyl Chloride	0.0015	0.003	0.0038
pH	within limits of 6.0—9.0 standard units at all times		

The EPA waiver is in effect.

**PA 0012599.** Industrial waste, **Simpson Paper Company**, 1301 Fifth Avenue, Suite 1200, Seattle, WA 98101-2613.

This application is for renewal of an NPDES permit to discharge untreated stormwater from a closed sludge impoundment, leachate from a closed impoundment and groundwater from a Simpson Paper Company site located in Whitmarsh Township, **Montgomery County**, PA. This is an existing discharge to the Schuylkill River.

The receiving stream is classified for warm water fish, migratory fish, potable water supply, industrial water supply, livestock water supply, wildlife water supply, irrigation, boating, fishing, water contact sports and esthetics.

The proposed effluent limits for Outfall 018, based on an average flow of 0.144 mgd are as follows:

<i>Parameter</i>	<i>Average Monthly (mg/l)</i>	<i>Maximum Daily (mg/l)</i>
CBOD <sub>5</sub>		monitor/report
Suspended Solids		monitor/report
Oil and Grease		monitor/report
pH		monitor/report
COD		monitor/report
Total Kjeldahl Nitrogen		monitor/report
Total Phosphorus		monitor/report
Dissolved Iron		monitor/report
Total Arsenic		monitor/report
Total Barium		monitor/report
Total Cadmium		monitor/report
Total Chromium		monitor/report
Total Copper		monitor/report
Total Lead		monitor/report
Total Mercury		monitor/report

<i>Parameter</i>	<i>Average Monthly (mg/l)</i>	<i>Maximum Daily (mg/l)</i>
Total Selenium		monitor/report

The EPA waiver is in effect.

*Northeast Regional Office: Water Management Program Manager, 2 Public Square, Wilkes-Barre, PA 18711-0790, (570) 826-2511.*

**A. 4899402. PA Department of Conservation and Natural Resources**, Bureau of State Parks, Delaware Canal State Park, 11 Lodi Hill Road, Upper Black Eddy, PA 18972-9540. Application to construct and operate a sewage treatment plant to serve the Teddy Roosevelt Picnic Area, located in Williams Township, **Northampton County**. Application received in the Regional Office—June 7, 1999.

*Southcentral Regional Office: Regional Water Management Program Manager, 909 Elmerton Avenue, Harrisburg, PA 17110-8200, (717) 705-4707.*

**PA 0052396**. Industrial waste, SIC: 3321, 3322, 3365 and 3644, **O-Z Gedney LLC**, 150 Birch Hill Road, Shoemakersville, PA 19555.

This application is for renewal of an NPDES permit for an existing discharge of treated industrial waste to an unnamed tributary of the Schuylkill River, in Perry Township, **Berks County**.

The receiving stream is classified for warm water fishes, recreation, water supply and aquatic life. For the purpose of evaluating effluent requirements for TDS, NO<sub>2</sub>-NO<sub>3</sub>, fluoride and phenolics, the existing downstream potable water supply intake considered during the evaluation was the Pottstown Borough located on the Schuylkill River. The discharge is not expected to impact any potable water supply.

The proposed effluent limits for Outfall 001 for a design flow of 0.042 mgd are:

<i>Parameter</i>	<i>Average Monthly (mg/l)</i>	<i>Maximum Daily (mg/l)</i>	<i>Instantaneous Maximum (mg/l)</i>
Flow		monitor and report	
pH		6.0—9.0 s.u. at all times	
Temperature		as required each month	

The proposed effluent limits for Outfall 002 are:

<i>Parameter</i>	<i>Average Monthly (mg/l)</i>	<i>Maximum Daily (mg/l)</i>	<i>Instantaneous Maximum (mg/l)</i>
CBOD		monitor and report	
Oil and Grease		monitor and report	
TSS		monitor and report	
Total Chromium		monitor and report	
Total Cadmium		monitor and report	
Total Zinc		monitor and report	
COD		monitor and report	
pH		monitor and report	
Total Lead		monitor and report	
Total Copper		monitor and report	
Total Arsenic		monitor and report	
Total Iron		monitor and report	

Persons may make an appointment to review the DEP files on this case by calling Mary DiSanto, File Review Coordinator, at (717) 705-4732.

The EPA waiver is in effect.

**PA 0052043**. Industrial waste, SIC: 2086, **Mid Atlantic Cannery Association**, 316 South Front Street, Hamburg, PA 19526.

This application is for renewal of an NPDES permit for an existing discharge of treated industrial waste to an unnamed tributary of the Schuylkill River, in Hamburg Borough, **Berks County**.

The receiving stream is classified for warm water fishes, recreation, water supply and aquatic life. For the purpose of evaluating effluent requirements for TDS, NO<sub>2</sub>-NO<sub>3</sub>, fluoride and phenolics, the existing downstream potable water supply intake considered during the evaluation was the Pottstown Borough located on the Schuylkill River. The discharge is not expected to impact any potable water supply.

The proposed effluent limits for Outfall 001 for a design flow of 0.003 mgd are:

<i>Parameter</i>	<i>Average Monthly (mg/l)</i>	<i>Maximum Daily (mg/l)</i>	<i>Instantaneous Maximum (mg/l)</i>
Flow			
pH		monitor and report 6.0—9.0 s.u. at all times	

Persons may make an appointment to review the DEP files on this case by calling Mary DiSanto, File Review Coordinator, at (717) 705-4732.

The EPA waiver is in effect.

**PA 0085731.** Industrial waste, SIC: 3089, **Brentwood Industries, Inc.**, 610 Morgantown Road, Reading, PA 19611-2012.

This application is for renewal of an NPDES permit for an existing discharge of treated industrial waste to Angelica Creek, in Reading City, **Berks County**.

The receiving stream is classified for cold water fishes, recreation, water supply and aquatic life. For the purpose of evaluating effluent requirements for TDS, NO<sub>2</sub>-NO<sub>3</sub>, fluoride and phenolics, the existing downstream potable water supply intake considered during the evaluation was Pottstown Borough located on the Schuylkill River. The discharge is not expected to impact any potable water supply.

The proposed effluent limits for Outfall 001 are:

<i>Parameter</i>	<i>Average Monthly (mg/l)</i>	<i>Maximum Daily (mg/l)</i>	<i>Instantaneous Maximum (mg/l)</i>
Flow			
pH	monitor and report	6.0—9.0 at all times	

The proposed effluent limits for Outfall 002 are:

<i>Parameter</i>	<i>Average Monthly (mg/l)</i>	<i>Maximum Daily (mg/l)</i>	<i>Instantaneous Maximum (mg/l)</i>
Flow			
pH	monitor and report	6.0—9.0 at all times	

Persons may make an appointment to review the DEP files on this case by calling Mary DiSanto, File Review Coordinator, at (717) 705-4732.

The EPA waiver is in effect.

*Southwest Regional Office: Water Management Program Manager, 400 Waterfront Drive, Pittsburgh, PA 15222-4745, (412) 442-4000.*

**PA 0098973.** Sewage. **Conemaugh Township Area Sewer Authority**, P. O. Box 429, Davidsville, PA 15928.

This application is for renewal of an NPDES permit to discharge treated sewage from Benson STP in Paint Township, **Somerset County**.

The following effluent limitations are proposed for discharge to the receiving waters, known as Stoney Creek, which are classified as a warm water fishery with existing and/or potential uses for aquatic life, water supply and recreation. The first downstream potable water supply intake from this facility is the Saltsburg Municipal Water Works.

*Outfall 001:* existing discharge, design flow of .1597 mgd.

<i>Parameter</i>	<i>Concentration (mg/l)</i>			
	<i>Average Monthly</i>	<i>Average Weekly</i>	<i>Maximum Daily</i>	<i>Instantaneous Maximum</i>
CBOD <sub>5</sub>	25	38		50
Suspended Solids	30	45		60
Fecal Coliform				
(5-1 to 9-30)	200/100 ml as a geometric mean			
(10-1 to 4-30)	70,000/100 ml as a geometric mean			
Total Residual Chlorine	1.0			3.3
pH	not less than 6.0 nor greater than 9.0			

The EPA waiver is in effect.

**PA 0215945.** Sewage, **Trinity Area School District**, 231 Park Avenue, Washington, PA 15301.

This application is for renewal of an NPDES permit to discharge treated sewage from Trinity South Elementary School Wastewater Treatment Plant in Amwell Township, **Washington County**.

The following effluent limitations are proposed for discharge to the receiving waters, known as Little Tenmile Creek, which are classified as a trout stock fishery with existing and/or potential uses for aquatic life, water supply and recreation. The first downstream potable water supply intake from this facility is the Marianna Municipal Water Works.

*Outfall 001:* existing discharge, design flow of .006 mgd.

<i>Parameter</i>	<i>Concentration (mg/l)</i>			
	<i>Average Monthly</i>	<i>Average Weekly</i>	<i>Maximum Daily</i>	<i>Instantaneous Maximum</i>
CBOD <sub>5</sub>	25			50
Suspended Solids	30			60
Ammonia Nitrogen (5-1 to 10-31)	8			16
(11-1 to 4-30)	24			48
Fecal Coliform (5-1 to 9-30)	200/100 ml as a geometric mean			
(10-1 to 4-30)	4,000/100 ml as a geometric mean			
Total Residual Chlorine (1st month—36th month)	monitor and report			
(37th month—expiration)	0.7			1.7
Dissolved Oxygen	not less than 3 mg/l			
pH	not less than 6.0 nor greater than 9.0			

The EPA waiver is in effect.

**PA 0216445.** Sewage, **Helicopter Aviation Services Corporation**, P. O. Box 1117, Mount Pleasant, PA 15666.

This application is for issuance of an NPDES permit to discharge treated sewage from the Helicopter Aviation Services Corporation Sewage Treatment Plant in Bullsken Township, **Fayette County**.

The following effluent limitations are proposed for discharge to the receiving waters, known as unnamed tributary of Jacobs Creek, which are classified as a warm water fishery with existing and/or potential uses for aquatic life, water supply and recreation. The first downstream potable water supply intake from this facility is the Westmoreland Municipal Authority.

*Outfall 001:* new discharge, design flow of 0.002 mgd.

<i>Parameter</i>	<i>Concentration (mg/l)</i>			
	<i>Average Monthly</i>	<i>Average Weekly</i>	<i>Maximum Daily</i>	<i>Instantaneous Maximum</i>
CBOD <sub>5</sub>	25			50
Suspended Solids	30			60
Ammonia Nitrogen (5-1 to 10-31)	10			20
(11-1 to 4-30)	30			60
Fecal Coliform (5-1 to 9-30)	200/100 ml as a geometric mean			
(10-1 to 4-30)	2,000/100 ml as a geometric mean			
Total Residual Chlorine	1.4			3.3
pH	not less than 6.0 nor greater than 9.0			

The EPA waiver is in effect.

*Northwest Regional Office: Regional Manager; Water Management, 230 Chestnut Street, Meadville, PA 16335, (814) 332-6942.*

**PA 0035114.** Industrial waste, SIC: 3471, 3315 and 3351, **Torpedo Specialty Wire, Inc.**, R. D. 2, Route 27, Pittsfield, PA 16340.

This application is for renewal of an NPDES permit, to discharge treated industrial waste and stormwater to Gar Run in Pittsfield Township, **Warren County**. This is an existing discharge.

The receiving water is classified for the following uses: cold water fishes, aquatic life, water supply and recreation. For the purpose of evaluating effluent requirements for TDS, NO<sub>2</sub>-NO<sub>3</sub>, fluoride and phenolics, the existing downstream potable water supply considered during the evaluation is the Emlenton Water Company on the Allegheny River located at Emlenton, approximately 87 miles below point of discharge.

The proposed discharge limits, based on a design flow of .0045 mgd, are:

*Outfall No. 001*

<i>Parameter</i>	<i>Average Monthly (mg/l)</i>	<i>Maximum Daily (mg/l)</i>	<i>Instantaneous Maximum (mg/l)</i>
Flow (mgd)			
Cadmium			.092
Chromium (T)			4.38
Copper			.46
Lead			.15

## NOTICES

<i>Parameter</i>	<i>Average Monthly (mg/l)</i>	<i>Maximum Daily (mg/l)</i>	<i>Instantaneous Maximum (mg/l)</i>
Nickel			4.61
Silver			.076
Zinc			.76
Cyanide (T)			.95
Fluoride			170.4
Total Suspended Solids	30	60	75
Oil and Grease	15		30
pH		6.0—9.0 at all times	

The proposed discharge limits, based on a design flow of n/a mgd, are:

*Outfall No. 003/004*

<i>Parameter</i>	<i>Average Monthly (mg/l)</i>	<i>Maximum Daily (mg/l)</i>	<i>Instantaneous Maximum (mg/l)</i>
These discharges shall consist of uncontaminated stormwater only. Refer to Special Condition E in Part C of this permit			

The EPA waiver is not in effect.

**PA 0100536.** Industrial waste, SIC: 4941, **DCNR Chapman State Park**, R. R. 2, Box 1610, Clarendon, PA 16313.

This application is for renewal of an NPDES permit, to discharge treated waste from an industrial waste treatment plant and sewage treatment plant to unnamed tributaries to West Branch Tionesta Creek in Pleasant Township, **Warren County**. This is an existing discharge.

The receiving water is classified for the following uses: HQ CWF, aquatic life, water supply and recreation. For the purpose of evaluating effluent requirements for TDS, NO<sub>2</sub>-NO<sub>3</sub>, fluoride and phenolics the existing/proposed downstream potable water supply considered during the evaluation is the Emlenton Water Company on the Allegheny River located at river mile 90, approximately 116.4 miles below point of discharge.

The proposed discharge limits, based on a design flow of 0.002 mgd, are:

*Outfall No. 001*

<i>Parameter</i>	<i>Average Monthly (mg/l)</i>	<i>Maximum Daily (mg/l)</i>	<i>Instantaneous Maximum (mg/l)</i>
Flow	monitor and report		
Total Suspended Solids	30	60	75
Total Aluminum	4	8	10
Total Iron	2	4	5
Total Manganese	1	32	2.5
Total Residual Chlorine	1.5		3.5
pH		6.0—9.0 at all times	

The proposed discharge limits, based on a design flow of 0.0005 mgd, are:

*Outfall No. 002*

<i>Parameter</i>	<i>Average Monthly (mg/l)</i>	<i>Maximum Daily (mg/l)</i>	<i>Instantaneous Maximum (mg/l)</i>
Flow	monitor and report		
CBOD <sub>5</sub>	25		50
Total Suspended Solids	30		60
Ammonia as Nitrogen			
(5-1 to 10-30)	14		28
(11-1 to 4-30)	42		84
Total Residual Chlorine	1.5		3.5
Dissolved Oxygen			
Fecal Coliform	200		
Fecal Coliform	100,000		
pH		6.0—9.0 at all times	

The EPA waiver is in effect.

---

**NPDES Minor Renewals**

---

*Southcentral Regional Office: Water Management Program, 909 Elmerton Avenue, 2nd Floor, Harrisburg, PA 17110, (717) 705-4707.*

<i>NPDES No.</i>	<i>Facility Name and Address</i>	<i>County and Municipality</i>	<i>Tributary Stream</i>	<i>New Permit Requirements</i>
PA 0084964	Bethel Township Sewer Auth. P. O. Box 239 Warfordsburg, PA 17267	Fulton Bethel Twp.	UNT to Little Tonoloway	TRC
PA 0024139	Cumberland Township Auth. 1270B Fairfield Road Gettysburg, PA 17325	Adams Cumberland Twp.	UNT to Rock Creek	TRC
PA 0070149	Leesport Borough Authority 10 East Wall Street Leesport, PA 19533	Berks Leesport	UNT to Schuylkill River	TRC
PA 0021849	Millerstown Borough Municipal Authority P. O. Box 200 Millerstown, PA 17062	Perry Millerstown Borough	UNT to Juniata River	TRC

---

**DISCHARGE OF CONTROLLED INDUSTRIAL WASTE AND SEWERAGE WASTEWATER**
**Applications under the Pennsylvania Clean Streams Law**
**(Part II Permits)**

The following permit applications and requests for plan approval have been received by the Department of Environmental Protection (Department).

Persons objecting on the grounds of public or private interest to the approval of an application or submitted plan may file a written protest with the Department at the address indicated above each permit application or plan. Each written protest should contain the following: name, address and telephone number; identification of the plan or application to which the protest is addressed; and a concise statement in sufficient detail to inform the Department of the exact basis of the protest and the relevant facts upon which it is based. The Department may conduct a fact-finding hearing or an informal conference in response to any given protest. Each commentator will be notified in writing of the time and place if a hearing or conference concerning the plan, action or application to which the protest relates is held. To insure consideration by the Department prior to final action on permit applications and proposed plans, initial protests and additions or amendments to protests already filed should be filed within 15 calendar days from the date of this issue of the *Pennsylvania Bulletin*. A copy of each permit application and proposed plan is on file in the office indicated and is open to public inspection.

Persons with a disability who wish to attend the hearing and require an auxiliary aid, service or other accommodation to participate in the proceeding should contact the Secretary to the Board at (717) 787-3483. TDD users may contact the Department through the Pennsylvania AT&T Relay Service at (800) 654-5984.

---

**Industrial waste and sewerage applications under The Clean Streams Law (35 P. S. §§ 691.1—691.1001).**

---

*Southeast Regional Office: Regional Water Management Program Manager, Lee Park, Suite 6010, 555 North Lane, Conshohocken, PA 19428, (610) 832-6130.*

---

**WQM Permit No. 4699416.** Sewerage. **Upper Merion Township**, 175 West Valley Forge Road, King of Prussia, PA 19406-0139. This project is for the construction and operation of a sewage pumping station to serve Glenn Rose subdivision located in Upper Merion Township, **Montgomery County**.

**WQM Permit No. 4699417.** Sewerage. **Worcester Township**, 1721 Valley Forge Road, P. O. Box 767, Worcester, PA 19490-0767. This project is for the construction and operation to expand the existing Meadowood Wastewater pumping station to serve the Worcester Elementary School located in Worcester Township, **Montgomery County**.

**WQM Permit No. 2399404.** Sewerage. **Delaware County Regional Water Quality Control Authority**, 100 East Fifth Street, P. O. Box 999, Chester, PA 19016. This project is for the construction and operation of a sanitary sewer line and modifications to an existing pump station located in Ridley Township, **Delaware County**.

*Southwest Regional Office: Water Management Program Manager, 400 Waterfront Drive, Pittsburgh, PA 15222-4745, (412) 442-4000.*

**A. 6587201-A2.** Industrial waste. **Westinghouse Electric Company**, R. D. 4, Box 333, Westinghouse Road, Blairsville, PA 15717-8904. Application for the modification and operation of a new groundwater treatment system to serve the Specialty Metals Plant located in Derry Township, **Westmoreland County**.

**A. 0399401.** Sewerage. **Jeffrey and Margaret Isaacson**, R. D. 1, Box 213C, Cowansville, PA 16218. Application for construction and operation of a small flow sewage treatment plant to serve the Isaacson residence located in Sugarcreek Township, **Armstrong County**.

*Northwest Regional Office: Regional Water Management Program Manager, 230 Chestnut Street, Meadville, PA 16335-3481, (814) 332-6942.*

**WQM Permit No. 4399414.** Sewage, **Terry Mariacher, SRSTP**, 441 East Jamestown Road, Greenville, PA 16125. This project is for the construction of a single residence sewage treatment plant in West Salem Township, **Mercer County**.



**INDIVIDUAL PERMITS  
(PAS)**

**NPDES Individual**

The following parties have applied for an NPDES permit to discharge stormwater from a proposed construction activity into the surface waters of this Commonwealth. Unless otherwise indicated, on the basis of preliminary review and application of lawful standards and regulations, the Department of Environmental Protection (Department) proposes to issue a permit to discharge, subject to certain limitations set forth in the permit and special conditions. The proposed determinations are tentative. Limitations are provided in the permit as erosion and sedimentation control measures and facilities which restrict the rate and quantity of sediment discharged.

Where indicated, the EPA, Region III, Regional Administrator has waived the right to review or object to this proposed permit action under the waiver provision of 40 CFR 123.24(d).

Persons wishing to comment on the proposed permit are invited to submit a statement to the office noted above the application within 30 days from the date of this public notice. Comments reviewed within this 30-day period will be considered in the formulation of the final determinations regarding this application. Responses should include the name, address and telephone number of the writer and a concise statement to inform the Department of the exact basis of a comment and the relevant facts upon which it is based. A public hearing may be held if the responsible office considers the public response significant.

Following the 30-day comment period, the Water Management Program Manager will make a final determination regarding the proposed permit. Notice of this determination will be published in the *Pennsylvania Bulletin* at which time this determination may be appealed to the Environmental Hearing Board.

The application and related documents, including the erosion and sedimentation control plan for the construction activity, are on file and may be inspected at the office noted above the application.

Persons with a disability who wish to attend the hearing and require an auxiliary aid, service or other accommodation to participate in the proceedings, should contact the specified program. TDD users may contact the Department through the Pennsylvania AT&T Relay Service at (800) 654-5984.

*Southeast Regional Office: Regional Water Management Program Manager, Lee Park, Suite 6010, 555 North Lane, Conshohocken, PA 19428-2233, (610) 832-6130.*

**NPDES Permit No. PAS10-G368.** Stormwater. **Ephraim Hershey**, 176 Log House Road, Oxford, PA 19363, has applied to discharge stormwater from a construction activity located in Upper Oxford Borough, **Chester County**, to Big Elk Creek.

*Northeast Regional Office: Regional Water Management Program Manager, 2 Public Square, Wilkes-Barre, PA 18711-0790, (570) 826-2511.*

*Lehigh County Conservation District, District Manager, Lehigh Ag. Ctr., Ste. 102, 4184 Dorney Park Road, Allentown, PA 18104, (610) 391-9583.*

**NPDES Permit PAS10Q175.** Stormwater. **William Locke, Jr.**, 4 Running Road, Manchester-by-The-Sea, MA 10944, has applied to discharge stormwater from a con-

struction activity located in Upper Macungie Township, **Lehigh County**, to Little Lehigh Creek.

*Monroe County Conservation District, District Manager, 8050 Running Valley Road, Stroudsburg, PA 18360, (570) 629-3060.*

**NPDES Permit PAS10S024-R.** Stormwater. **The Woodlands**, Pine Ridge Equities, 400 Lincoln Avenue, Rutherford, NJ 07070, has applied to discharge stormwater from a construction activity located in Pocono and Stroud Townships, **Monroe County**, to Pocono Creek.

*Northwest Regional Office: Regional Water Management Program Manager, 230 Chestnut Street, Meadville, PA 16335-3481, (814) 332-6942.*

**NPDES Permit PAS 102700.** Stormwater. **Independent Pipeline Company**, 500 Renaissance Center, Detroit, MI 48243-1902, has applied to discharge stormwater from a construction activity to various streams in 11 Pennsylvania counties, beginning at the Ohio-Pennsylvania border in **Lawrence County** and proceeding eastward through **Lawrence, Butler, Armstrong, Clarion, Jefferson, Elk, Forest, McKean, Cameron, Potter and Clinton Counties**.

The construction activity for Lawrence County is located in Little Beaver Township, New Beaver Borough, Wayne Township and Perry Township with discharges of stormwater to the following streams: Little Beaver River, North Fork Little Beaver Creek, Honey Creek, Beaverdam Run, Eckles Run, Beaver River, Snake Run, Vinegar Valley Run, Duck Run, Squaw Run, Skunk Run, Slippery Rock Creek and several unnamed tributaries.

The construction activity for Butler County is located in Muddy Creek Township, Franklin Township, Clay Township, Concord Township and Fairview Township with discharges of stormwater to the following streams: Camp Run, Little Yellow Creek, Shannon Run, Swamp Run, Muddy Creek, Stony Run Connoquenessing Creek, Bear Creek, South Branch Bear Creek and several unnamed tributaries.

The construction activity for Armstrong County is located in Perry Township with discharges of stormwater to the following streams: unnamed tributaries to Cove Run and Allegheny River.

The construction activity for Clarion County is located in Toby Township, Porter Township, Redbank Township, Limestone Township and Clarion Township with discharges of stormwater to the following streams: Allegheny River, Black Fox Run, Catfish Run, Cherry Run, Wildcat Run, East Fork Wildcat, Fiddlers Run, West Fork Leatherwood Creek, Jack Run, Leisure Run, Town Run, Piney Creek, Little Piney Creek, Little Mill Creek and several unnamed tributaries.

The construction activity for Jefferson County is located in Union Township, Eldred Township, Barnett Township and Heath Township with discharges of stormwater to the following streams: Little Mill Creek, Mill Creek, Black Run, Cathers Run, Truby Run, Clear Creek, Clarion River and several unnamed tributaries.

The construction activity for Elk County is located in Millstone Township, Highland Township and Jones Township with discharges of stormwater to the following streams: Millstone Creek, Gregg Run, Steck Run, Hill Run, Pigeon Run, Maple Run, Ellithorpe Run, Cherry Run, Big Mill Creek, Wolf Run, Wilson Run, West Branch Clarion River, Rocky Run, East Branch Clarion River, Wellondorf Branch and several unnamed tributaries.

The construction activity for Forest County is located in Jenks Township with discharges of stormwater to the following streams: Spring Creek and Hill Run.

The construction activity for McKean County is located in Sergeant Township and Norwich Township with discharges of stormwater to the following streams: Rocky Run, Sevenmile Run, Fivemile Run, East Branch Clarion River, North Fork Straight Creek, South Fork West Branch Potato Creek, Elk Fork and several unnamed tributaries.

The construction activity for Cameron County is located in Shippen Township and Portage Township with discharges of stormwater to the following streams: Oviatt Branch, Elk Fork, Bewer Fork, Havens Run, Right Branch Cooks Run, North Creek, Pepper Run, Waldy Run, Fourmile Run, Sinnemahoning Creek, Salt Run, Radnor Hollow, Bucher Hollow, McNuff Branch and several unnamed tributaries.

The construction activity for Potter County is located in Portage Township and Wharton Township with discharges of stormwater to the following streams: McNuff Branch, Baily Run, Little Baily Run, First Fork Sinnemahoning Creek, East Fork Sinnemahoning Creek, Right Branch Lushbough Run, Calhoun Branch, and John Summerson Branch Trout Run and several unnamed tributaries.

The construction activity for Clinton County is located in Leidy Township with discharges of stormwater to the following streams: John Summerson Branch Trout Run, Daugherty Run, Kettle Creek and several unnamed tributaries.

## SAFE DRINKING WATER

**Applications received under the Pennsylvania Safe Drinking Water Act (35 P. S. §§ 721.1—721.17).**

*Southeast Regional Office: Sanitarian Regional Manager, Lee Park, Suite 6010, 555 North Lane, Conshohocken, PA 19428-2233, (610) 832-6130.*

**A. 115647.** Public water supply. **Springton Water Company**, P. O. Box 348, Lyndell, PA 19354. This proposal involves the installation of a 4,000 storage tank and three water vending machines at the Marchwood Shopping Center in Uwchlan Township, **Chester County**.

*Northeast Regional Office: Sanitarian Regional Manager, 2 Public Square, Wilkes-Barre, PA 18711-0790, (717) 826-2511.*

**4899502.** Public water supply. **Hickory Hills Mobile Home Court**, 12 Hickory Hills Drive, Bath, PA 18014, Louise Kromer, Manager. This proposal involves replacing a 23,000 gallon storage tank with a hydropneumatic tank and water softeners with chemical injection for sequestering iron and manganese. It is located in Moore Township, **Northampton County**. *Engineer: Harry E. Garman, Mace Consulting Engineers*

**4899503.** Public water supply. **Ashland Specialty Chemical Company**, 400 Island Park Road, Easton, PA 18042. This proposal involves the installation of an air stripper to remove VOCs from the well water from the two sources of supply. *Engineer: Edward Sapp, UNI Engineering.*

*Southcentral Regional Office: Sanitarian Regional Manager, 909 Elmerton Avenue, Harrisburg, PA 17110-8200, (717) 705-4708.*

**Permit No. 0799501.** Public water supply, **Duncansville Municipal Authority**, Duncansville/Allegheny,

**Blair County.** *Responsible Official: James Grove, Superintendent, Borough of Duncansville, P. O. Box 308, Duncansville, PA 16635-1349. Type of Facility: Installation of a chemical feed system at the water treatment plant. System will feed Aqua Mag to reduce calcium scale. Consulting Engineer: Stuart W. Sibold, PE, The EADS Group, Inc., 1126 Eighth Avenue, Altoona, PA 16602. Application received: May 17, 1999.*

*Regional Office: Northcentral Field Operations, Environmental Program Manager, 208 West Third Street, Suite 101, Williamsport, PA 17701.*

**A. 1799501.** The Department has received a permit application from the **Country Place MHP**, R. D. 2, Box 71, DuBois, PA 15801-9710, Sandy Township, **Clearfield County**, to construct a new water well and pipe to existing water tank. The well pump will be used to pump to the tank.

**A. MA.** The Department has received a permit application from **Sandy Ridge Water Authority**, P. O. Box 200, Sandy Ridge, PA 16677, Rush Township, **Centre County**, to install pH adjustment chemical feed system for optimum corrosion control treatment.

## LAND RECYCLING AND ENVIRONMENTAL REMEDIATION

Under Act 2, 1995

Preamble 1

**Acknowledgment of Notice of Intent to Remediate submitted under the Land Recycling and Environmental Remediation Standards Act (35 P. S. §§ 6026.101—6026.908).**

Sections 302, 303, 304 and 305 of the Land Recycling and Environmental Remediation Standards Act (act) require the Department of Environmental Protection (Department) to publish in the *Pennsylvania Bulletin* an acknowledgment noting receipt of any Notices of Intent to Remediate. An acknowledgment of the receipt of a Notice of Intent to Remediate is used to identify a site where a person proposes to, or has been required to, respond to a release of a regulated substance at a site. Persons intending to use the background standard, Statewide health standard, the site-specific standard, or who intend to remediate a site as a special industrial area, must file a Notice of Intent to Remediate with the Department. A Notice of Intent to Remediate filed with the Department provides a brief description of the location of the site, a list of known suspected contaminants at the site, the proposed remediation measures for the site and a description of the intended future use of the site. A person who demonstrates attainment of one, or a combination of the cleanup standards, or who receives approval of a special industrial area remediation identified under the act, will be relieved of further liability for the remediation of the site for any contamination identified in reports submitted to and approved by the Department. Furthermore, the person shall not be subject to citizen suits or other contribution actions brought by responsible persons not participating in the remediation.

Under sections 304(n)(1)(ii) and 305(c)(2) of the act, there is a 30-day public and municipal comment period for sites proposed for remediation using a site-specific standard, in whole or in part, and for sites remediated as a special industrial area. This period begins when a summary of the Notice of Intent to Remediate is published in a newspaper of general circulation in the area of the site. For the sites identified as proposed for remedia-

tion to a site-specific standard or as a special industrial area, the municipality, within which the site is located, may request to be involved in the development of the remediation and reuse plans for the site if the request is made within 30 days of the date specified. During this comment period the municipality may request that the person identified as the remediator of the site, develop and implement a public involvement plan. Requests to be involved, and comments, should be directed to the remediator of the site.

For further information concerning the content of a Notice of Intent to Remediate, contact the Environmental Cleanup Program Manager in the Department's Regional Office under which the notice appears. If information concerning this acknowledgment is required in an alternative form, contact the Community Relations Coordinator at the appropriate Regional Office listed. TDD users may telephone the Department through the AT&T Relay Service at (800) 654-5984.

The Department has received the following Notices of Intent to Remediate:

*Southeast Regional Office: Environmental Cleanup Program Manager, Lee Park, Suite 6010, 555 North Lane, Conshohocken, PA 19428, (610) 832-5950.*

**Unisys Downingtown Facility (Former)**, Downingtown Borough, **Chester County**. Randy L. Shuler, Environmental Resources Management, Princeton Crossroads, 250 Phillips Boulevard, Suite 280, Ewing, NJ 08618, has submitted a Notice of Intent to Remediate site soil and groundwater contaminated with heavy metals and solvents. The applicant proposes to remediate the site to meet Statewide health and site-specific standards. A summary of the Notice of Intent to Remediate was reported to have been published in *The Daily Local News* on May 25, 1999.

**Unisys Corp.**, Blue Bell, PA, Whitpain Township, **Montgomery County**. William J. Ponticello, P.G., Penn E & R, Inc., 2755 Bergey Road, Hatfield, PA 19440, has submitted a Notice of Intent to Remediate site groundwater contaminated with solvents. The applicant proposes to remediate the site to meet the Statewide health standard. A summary of the Notice of Intent to Remediate was reported to have been published in *The Times Herald* on May 10, 1999.

**Reiniger Brothers, Inc. and Reiniger Brothers**, Upper Moreland Township, **Montgomery County**. Darryl D. Borrelli, Manko, Gold & Katcher, LLP, 401 City Avenue, Suite 500, Bala Cynwyd, PA 19004, has submitted a Notice of Intent to Remediate site soil contaminated with lead, heavy metals and pesticides. The applicant proposes to remediate the site to meet the Statewide health standard. A summary of the Notice of Intent to Remediate was reported to have been published in *The Record* on June 3, 1999.

## **SOLID AND HAZARDOUS WASTE OPERATE WASTE PROCESSING OR DISPOSAL AREA OR SITE**

**Applications submitted under the Solid Waste Management Act (35 P. S. §§ 6018.101—6018.1003), the Municipal Waste Planning, Recycling and Waste Reduction Act (53 P. S. §§ 4000.101—4000.1904) and regulations to operate solid waste processing or disposal area or site.**

*Regional Office: Regional Solid Waste Manager, Suite 6010, 555 North Lane, Lee Park, Conshohocken, PA 19428.*

**A. 101069. SECCRA Landfill**, 219 West Street Road, Kennett Square, PA 19348. Application was received for the expansion of the SECCRA Landfill, which is located in London Grove Township, **Chester County**. Application was received in the Southeast Regional Office on June 11, 1999.

**A. 100973. Quickway Transfer Station**, 2900 Orthodox Street, Philadelphia, PA 19137. Application was received for the reissuance of their solid waste Permit No. 100973 from USA Waste Transfer of Philadelphia, Inc., to Republic Services Group of PA II, LLC. Facility is located in the **City of Philadelphia**. Application was received in the Southeast Regional Office on June 14, 1999.

**A. 101468. Girard Point Transfer Station**, 3600 South 26th Street, Philadelphia, PA 19145. Application was received for the reissuance of solid waste Permit No. 101468 from USA Waste Transfer of Philadelphia, Inc., to Republic Services Group of Pennsylvania I, LLC. Facility located in the **City of Philadelphia**. Application was received in the Southeast Regional Office on June 14, 1999.

## **AIR QUALITY**

### **Notice of Plan Approval and Operating Permit Applications**

#### **Nonmajor Sources and Modifications**

The Department of Environmental Protection (Department) has developed an integrated plan approval, State operating permit and Title V operating permit program. This integrated approach is designed to make the permitting process more efficient for the Department, the regulated community and the public. This approach allows the owner or operator of a facility to complete and submit all the permitting documents relevant to its application one time, affords an opportunity for public input and provides for sequential issuance of the necessary permits.

The Department has received applications for plan approvals and/or operating permits from the following facilities. Although the sources covered by these applications may be located at a major facility, the sources being installed or modified do not trigger major new source review or prevention of significant deterioration requirements.

Copies of these applications, subsequently prepared draft permits, review summaries and other support materials are available for review in the Regional Offices identified in this notice. Persons interested in reviewing the application files should contact the appropriate regional office to schedule an appointment.

Persons wishing to file protests or comments on the proposed plan approval and/or operating permits must submit the protest or comment within 30 days from the date of this notice. Interested persons may also request that a hearing be held concerning the proposed plan approval and operating permit. Comments or protests filed with the Department's Regional Offices must include a concise statement of the objections to the issuance of the plan approval or operating permit and relevant facts which serve as the basis for the objections. If the Department schedules a hearing, a notice will be published in the *Pennsylvania Bulletin* at least 30 days prior to the date of the hearing.

Final plan approvals and operating permit will contain terms and conditions to ensure that the source is constructed and operating in compliance with applicable

requirements in 25 Pa. Code Chapters 121—143, the Federal Clean Air Act and regulations adopted under the act.

### OPERATING PERMITS

#### Applications received and intent to issue Operating Permits under the Air Pollution Control Act (35 P. S. §§ 4001—4015).

*Northeast Regional Office: Air Quality Program, Two Public Square, Wilkes-Barre, PA 17811-0790, (570) 826-2531.*

**35-399-018A: General Dynamics Land Systems** (175 East Street, Eynon, PA 18403), for operation of a descaling and peening operation in Archbald Borough, **Lackawanna County**.

#### Notice of Intent to Issue Title V Operating Permits

Under 25 Pa. Code § 127.521, notice is given that the Department of Environmental Protection (Department) intends to issue a Title V Operating Permit to the following facilities. These facilities are major facilities subject to the operating permit requirements under Title V of the Federal Clean Air Act and 25 Pa. Code Chapter 127, Subchapters F and G (relating to operating permit requirements; and Title V operating permits).

Appointments to review copies of the Title V application, proposed permit and other relevant information must be made by contacting Records Management at the regional office telephone number noted. For additional information, contact the regional office noted.

Interested persons may submit written comments, suggestions or objections concerning the proposed Title V permit to the regional office within 30 days of publication of this notice. Written comments submitted to the Department during the 30-day public comment period shall include the name, address and telephone number of the person submitting the comments, along with the reference number of the proposed permit. The commentator should also include a concise statement of objections to the permit issuance and the relevant facts upon which the objections are based.

The Department reserves the right to hold a public hearing on the proposed action based upon the information received during the public comment period and will provide notice of any scheduled public hearing at least 30 days in advance of the hearing. The hearing notice will be published in the *Pennsylvania Bulletin* and a newspaper of general circulation where the facility is located.

*Northcentral Regional Office: Air Quality Program, 208 West Third Street, Suite 101, Williamsport, PA 17701, Attn: Muhammad Zaman, (570) 327-3637.*

**TVOP-49-00001: Foster Wheeler Mt. Carmel, Inc.** (P. O. Box 490-D, Marion Heights Road, Marion Heights, PA 17832-0490), for their cogeneration facility (Cogen) and associated culm processing plant located in Mount Carmel Township, **Northumberland County**. The facility's main sources include a Foster Wheeler Circulating Fluidized Bed Boiler (Cogen), several storage silos, culm processing equipment and combustion sources. These sources emit major quantities of nitrogen oxides (NOx), carbon monoxide (CO), sulfur oxides (SOx), particulate matter and hazardous air pollutants (HAPs). As a result of the major quantities of NOx, CO, SOx, particulate matter and HAPs emitted, Foster Wheeler Mt. Carmel, Inc.'s Cogeneration Facility (Cogen) and associated culm processing plant is a major stationary source as defined

in Title I, Part D of the Clean Air Act Amendments. The facility is therefore subject to the Title V permitting requirements adopted in 25 Pa. Code, Chapter 127, Subchapter G. The sources also emit volatile organic compounds (VOCs). This facility is also subject to all applicable requirements of Reasonably Available Control Technology (RACT) for NOx emissions.

**TVOP-59-00003: Osram Sylvania Products, Inc.** (1 Jackson Street, Wellsboro, PA 16901), for their incandescent lightbulb facility located in Wellsboro Borough, **Tioga County**. The facility's main sources include a regenerative glass furnace, natural gas-fired boilers, a ceramic coating process, a chrome plating operation, solvent processes and several natural-gas fired processes. These sources emit major quantities of nitrogen oxides (NOx), sulfur oxides (SOx), hazardous air pollutants (HAPs) and particulate matter. As a result of the major quantities of NOx, SOx, HAPs and particulate matter emitted, the Osram Wellsboro facility is a major stationary source as defined in Title I, Part D of the Clean Air Act Amendments. The facility is therefore subject to the Title V permitting requirements adopted in 25 Pa. Code, Chapter 127, Subchapter G. The sources also emit carbon monoxide (CO) and volatile organic compounds (VOCs). This facility is also subject to all applicable requirements of Reasonably Available Control Technology (RACT) for NOx emissions.

### PLAN APPROVALS

#### Applications received and intent to issue Plan Approvals under the Air Pollution Control Act (35 P. S. §§ 4001—4015).

*Southeast Regional Office: Air Quality Program, 555 North Lane, Conshohocken, PA 19428, (610) 832-6242.*

**PA-23-0001D: Sunoco, Inc.** (Delaware Avenue and Green Street, Marcus Hook, PA 19061), for a storage tank in Marcus Hook Borough, **Delaware County**.

**PA-23-0009: Boeing Co., The** (Stewart Avenue and Route 291, Ridley, PA 19078), for installation of two-stage dry particulate filters in Ridley Township, **Delaware County**.

**PA-46-0005K: Merck & Co., Inc.** (770 Sumneytown Pike, West Point, PA 19486), for a Boiler No. 4 in Upper Gwynedd Township, **Montgomery County**.

**PA-15-0013A: Graphic Packaging Corp.** (2400 Continental Boulevard, Malvern, PA 19355), for modification of a flexographic/gravure press in Tredyffrin Township, **Chester County**.

**PA-23-0001F: Sunoco, Inc.** (Delaware Avenue and Green Street, Marcus Hook, PA 19061), for a storage tank in Marcus Hook Borough, **Delaware County**.

**PA-23-0001E: Sunoco, Inc.** (Delaware Avenue and Green Street, Marcus Hook, PA 19061), for a storage tank in Marcus Hook Borough, **Delaware County**.

**PA-23-0077: County of Delaware** (340 North Middletown Road, Lima, PA 19037), for construction of a natural gas-fired generator in Middletown Township, **Delaware County**.

**PA-23-0031: Mercy Fitzgerald Hospital** (1500 Lansdowne Avenue, Darby, PA 19023), for installation of an MSB emergency generator in Darby Borough, **Delaware County**.

**OP-46-0022B: Elf Atochem North America, Inc.** (900 First Avenue, King of Prussia, PA 19406), for modification of two boilers in Upper Merion Township, **Montgomery County**.

**PA-09-0021: MRI Flexible Packaging** (122 Penns Trail, Newtown, PA 18940), for modification of a flexographic printing press in Newtown Township, **Bucks County**.

*Northeast Regional Office: Air Quality Program, Two Public Square, Wilkes-Barre, PA 17811-0790, (570) 826-2531.*

**35-399-033: Hospital Central Services Corp.** (HCSC Laundry, 317 Linden Street, Scranton, PA 18503), for construction of a linen drying operation in Scranton, **Lackawanna County**.

**48-320-011: Alcom Printing Group, Inc.** (Lehigh Litho, Inc., 2285 Avenue A, Lehigh Valley Industrial Park, Bethlehem, PA 18017), for construction of a lithographic printing operation in Bethlehem, **Northampton County**.

**66-315-036: Procter & Gamble Paper Products Co., Inc.** (P. O. Box 32, Mehoopany, PA 18629), for modification of paper conversion lines and associated printing in Washington Township, **Wyoming County**.

*Southcentral Regional Office: Air Quality Program, 909 Elmerton Avenue, Harrisburg, PA 17110, (717) 705-4702.*

**01-310-050A: Valley Quarries, Inc.** (P. O. Box J, Chambersburg, PA 17201), for modification/installation of an additional double deck screen for a crushing and screening plant in Hamiltonban Township, **Adams County**. The source is subject to 40 CFR Part 60, Subpart OOO—Standards of Performance for Nonmetallic Mineral Processing Plants.

**06-3106: Behringer Saws, Inc.** (721 Hemlock Road, Morgantown, PA 19543), for surface coating operation controlled by dry filters in Caernarvon Township, **Berks County**.

**06-318-042E: Reynolds Metals Co.** (County Line Road, R. D. 1, Boyertown, PA 19512), for installation of a flexographic printing press in Colebrookdale Township, **Berks County**.

**22-03021A: A. P. Green Refractories, Inc.** (P. O. Box 189, 105 North Wood Street, Middletown, PA 17057), for installation of a 1 ton per hour mixer for an existing process for the manufacture of solid ceramic shapes in Middletown Borough, **Dauphin County**.

**28-03004A: Bri-Mar Mfg. LLC.** (1080 South Main, Chambersburg, PA 17201), for moving two paint booths from their old location to their new location in Chambersburg Borough, **Franklin County**.

**28-03025: Wenger's Feed Mill, Inc.** (111 West Harrisburg Avenue, Rheems, PA 17570-0026), for construction of a feed mill facility in South Hampton Township, **Franklin County**.

**67-05070A: Graham Packaging Co., L.P.** (420-B Emig Road, York, PA 17402), for installation of a bottle coating system controlled by a thermal oxidizer in Manchester Township, **York County**.

**67-320-026B: GTY, Inc.** (2075 Loucks Road, York, PA 17404), for installation of a hot embosser in West Manchester Township, **York County**.

*Northwest Regional Office: Air Quality Program, 230 Chestnut Street, Meadville, PA 16335-3481, (814) 332-6940.*

**PA-43-287A: Jones Performance Products, Inc.** (One Jones Way, West Middlesex, PA 16159-0808), for construction of a sheet mold compound press (300 tons) at a Title V facility in West Middlesex, **Mercer County**.

## MINING

### APPLICATIONS TO CONDUCT COAL AND NONCOAL ACTIVITIES

Applications under the Surface Mining Conservation and Reclamation Act (52 P. S. §§ 1396.1—1396.19a); the Noncoal Surface Mining Conservation and Reclamation Act (52 P. S. §§ 3301—3326); The Clean Streams Law (35 P. S. §§ 691.1—691.1001); the Coal Refuse Disposal Control Act (52 P. S. §§ 30.51—30.66); The Bituminous Mine Subsidence and Land Conservation Act (52 P. S. §§ 1406.1—1406.21). Mining activity permits issued in response to the applications will also address the applicable permitting requirements of the following statutes: the Air Pollution Control Act (35 P. S. §§ 4001—4015); the Dam Safety and Encroachments Act (32 P. S. §§ 693.1—693.27); and the Solid Waste Management Act (35 P. S. §§ 6018.101—6018.1003).

The following permit applications to conduct mining activities have been received by the Department of Environmental Protection (Department). A copy of the application is available for inspection at the District mining office indicated above each application. Where a 401 water quality certification is needed for any aspect of a particular proposed mining activity, the submittal of the permit application will serve as the request for the certification.

Written comments or objections, or requests for informal conferences on applications, may be submitted by any person or any officer or head of any Federal, State or local government agency or authority to the Department at the same address within 30 days of this publication, or within 30 days after the last publication of the applicant's newspaper advertisement, as provided by 25 Pa. Code §§ 77.121—77.123 and 86.31—86.34 (relating to public notices of filing of permit applications, opportunity for comment, and informal conferences).

Where any of the mining activities listed will have discharges of wastewater to streams, the Department will incorporate NPDES permits into the mining activity permits issued in response to these applications. The NPDES permits will contain, at a minimum, technology-based effluent limitations (as described in the Department's regulations—25 Pa. Code §§ 77.522, 87.102, 88.92, 88.187, 88.242, 89.52 and 90.102) for iron, manganese, suspended solids, settleable solids, alkalinity and pH. In addition to the above, more restrictive effluent limitations, restrictions on discharge volume or restrictions on the extent of mining which may occur will be incorporated into a mining activity permit when necessary for compliance with water quality standards (in accordance with 25 Pa. Code Chapters 93 and 95). Persons or agencies which have requested review of the NPDES permit requirements for a particular mining activity within the above-mentioned public comment period will be provided with a 30-day period to review and submit comments on those requirements.

Written comments or objections should contain the name, address and telephone number of persons submitting comments or objections; application number; and a statement of sufficient detail to inform the Department on the basis of comment or objection and relevant facts upon which it is based. Requests for an informal conference must contain the name, address and telephone number of requestor; application number; a brief summary of the issues to be raised by the requestor at the conference; and a statement whether the requestor desires to have the conference conducted in the locality of the proposed mining activities.

*Greensburg District Office, R. D. 2, Box 603-C, Greensburg, PA 15601.*

*Coal Applications Received*

**26940103R. Amerikohl Mining, Inc.** (202 Sunset Drive, Butler, PA 16001). Renewal application received for continued reclamation of a bituminous surface mine with a coal crusher located in Springfield Township, **Fayette County**, affecting 23.0 acres. Receiving streams: unnamed tributaries to Indian Creek to Youghiogheny River and unnamed tributaries to Mill Run to Indian Creek to the Youghiogheny River. Renewal application received: June 7, 1999.

**26940105R. Amerikohl Mining, Inc.** (202 Sunset Drive, Butler, PA 16001). Renewal application received for continued reclamation of a bituminous surface mine located in Springfield Township, **Fayette County**, affecting 75.5 acres. Receiving streams: unnamed tributary to Indian Creek to Youghiogheny River and Buck Run to Laurel Run to Indian Creek to Youghiogheny River. Renewal application received: June 7, 1999.

**65940106R. Amerikohl Mining, Inc.** (202 Sunset Drive, Butler, PA 16001). Renewal application received for continued reclamation of a bituminous surface mine with a coal crusher located in Derry Township, **Westmoreland County**, affecting 170.0 acres. Receiving streams: unnamed tributaries to Miller Run to Loyahanna Creek to the Kiskiminetas River. Renewal application received: June 7, 1999.

**03990103. Amerikohl Mining, Inc.** (202 Sunset Drive, Butler, PA 16001). Application received for commencement, operation and reclamation of a bituminous surface auger mine located in Cowanshannock Township, **Armstrong County**, proposed to affect 59.5 acres. Receiving streams: unnamed tributaries to Cowanshannock Creek, Cowanshannock Creek, Allegheny River. Application received: June 8, 1999.

**26870203R. Yowonske Construction Co.** (R. R. 3, Box 343-A, Belle Vernon, PA 15012-9803). Renewal application received for continued operation and reclamation of a coal refuse reprocessing site located in Redstone Township, **Fayette County**, affecting 52.0 acres. Receiving streams: Rowes Run to Redstone Creek to the Monongahela River. Renewal application received: June 16, 1999.

**03970105. State Industries, Inc.** (P. O. Box 1022, Kittanning, PA 16201). Application received for commencement, operation and reclamation of a bituminous surface auger mine with a preparation plant/processing facility located in Washington Township, **Armstrong County**, proposed to affect 413.0 acres. Receiving streams: unnamed tributaries to Limestone Run to the Allegheny River. Application received: June 14, 1999.

*Hawk Run District Office, P. O. Box 209, Off Empire Road, Hawk Run, PA 16840.*

**17990902. Johnson Bros. Coal Co.** (R. D. 1, Box 580, Mahaffey, PA 15757), commencement, operation and restoration of an incidental coal extraction permit in Penn Township, **Clearfield County** affecting 1.3 acres. Receiving streams: Kratzer Run. Application received June 7, 1999.

**17743165. Roy Coal Company** (Box 12, Olanta, PA 16863), renewal of an existing bituminous surface mine permit in Boggs Township, **Clearfield County** affecting 164.4 acres. Receiving streams: Little Clearfield Creek to Clearfield Creek and Clearfield Creek to West Branch of

the Susquehanna River to the Susquehanna River. Application received June 10, 1999.

**17990103. River Hill Coal Co., Inc.** (P. O. Box 141, Kylertown, PA 16847), reactivation of an application for a bituminous surface mine-auger permit for commencement, operation and restoration, Bigler Township, **Clearfield County** affecting 228.8 acres. Receiving streams: Upper Morgan Run, unnamed tributary to Upper Morgan Run, and Alexander Run. Application received March 19, 1999. Application returned May 6, 1999. Application reactivated June 8, 1999.

*Knox District Office, P. O. Box 669, Knox, PA 16232.*

**33890115. Fred A. Deemer, Jr.** (R. D. 1, Reynoldsville, PA 15851). Renewal of an existing bituminous surface mine operation in Washington Township, **Jefferson County**, affecting 40.0 acres. Receiving streams: Two unnamed tributaries to Sandy Lick Creek to Redbank Creek to the Clarion River to the Allegheny River. Application for reclamation only. Application received June 14, 1999.

**102911-10980110-E-3. Fleishner Excavating, Inc.** (350 Lardintown Road, Sarver, PA 16055). Application for a stream encroachment to encroach within 100 feet of Lardintown Run in Clinton Township, **Butler County**. Receiving streams: Unnamed tributaries to Lardintown Run (TSF) to Bull Creek (TSF) to the Allegheny River. Application received June 18, 1999.

*Pottsville District Office, 5 West Laurel Boulevard, Pottsville, PA 17901-2454.*

**54851336C7. Summit Anthracite, Inc.** (RR 1, Box 12A, Klingerstown, PA 17941), correction to an existing anthracite underground mine operation to add another mine opening in Porter Township, **Schuylkill County** affecting 6.7 acres, receiving stream—Good Spring Creek. Application received June 8, 1999.

**49970203C. Mid-Valley Coal Sales, Inc.** (5 Woodland Drive, Mt. Carmel, PA 17851), correction to an existing coal refuse reprocessing operation in Coal Township, **Northumberland County** affecting 533.0 acres, receiving stream—Shamokin Creek. Application received June 10, 1999.

**54880201R2. Blaschak Coal Corp.** (P. O. Box 12, Mahanoy City, PA 17948), renewal of a coal refuse reprocessing and breaker operation in Pine Grove Township, **Schuylkill County** affecting 61.4 acres, receiving stream—none. Application received June 11, 1999.

**54773223R3. CLS Coal Company** (P. O. Box 81, Port Carbon, PA 17965), renewal of an existing coal refuse reprocessing operation in Cass Township, **Schuylkill County** affecting 133.0 acres, receiving stream—none. Application received June 17, 1999.

*Knox District Office, P. O. Box 669, Knox, PA 16232.*

*Noncoal Applications Received*

**10940306. Quality Aggregates, Inc.** (200 Neville Road, Pittsburgh, PA 15225). Renewal of an existing limestone operation in Marion Township, **Butler County**, affecting 58.5 acres. Receiving streams: Unnamed tributaries to Slippery Rock Creek to Slippery Rock Creek and an unnamed tributary to Blacks Creek. Renewal of NPDES Permit No. PA0212091. Application received June 16, 1999.

*Pottsville District Office, 5 West Laurel Boulevard, Pottsville, PA 17901-2454.*

**5677SM1C4. Watsontown Brick Company** (P. O. Box 68, Watsontown, PA 17777), renewal of NPDES Permit No. PA0223263 in Delaware Township, **Northumberland County**, receiving stream—West Branch Susquehanna River. Application received June 7, 1999.

**40930302C. Linde Enterprises, Inc.** (R. R. 1, Box 1755, P. O. Box A, Honesdale, PA 18431), renewal of NPDES Permit No. PA0223280 in Pittston Township, **Luzerne County**, receiving stream—Mill Creek. Application received June 14, 1999.

**67990301. Glen-Gery Corporation** (P. O. Box 7001, Wyomissing, PA 19610-6001), commencement, operation and restoration of a quarry operation in Dover Township, **York County**, NPDES Permit No. PA0223999, affecting 39.866 acres, receiving stream—unnamed tributary of Fox Run. Application received June 14, 1999.

**21990301. Valley Quarries, Inc.** (P. O. Box J, Chambersburg, PA 17201-0809), commencement, operation and restoration of a quarry operation in Southampton Township, **Cumberland County** affecting 252.52 acres, receiving stream—unnamed tributary to Bulls Head Branch. Application received June 15, 1999.

*Ebensburg District Office, 437 South Center Street, P. O. Box 625, Ebensburg, PA 15931-0625.*

#### *Small Industrial Minerals Applications Received*

**11990801. Donald J. Brawley** (375 Stevens Road, Carrolltown, PA 15722), commencement, operation and restoration of a small industrial minerals mine in East Carroll Township, **Cambria County**, affecting 5.0 acres, receiving stream unnamed tributary to Laurel Lick Run. Application received June 16, 1999.

*Hawk Run District Office, P. O. Box 209, Off Empire Road, Hawk Run, PA 16840.*

#### *Large Industrial Mineral (Noncoal) Permit Applications Received*

**18832301. Mill Hall Clay Products, Inc.** (44 Market Street, Mill Hall, PA 17751), renewal of an existing large industrial mineral NPDES permit in Bald Eagle Township, **Clinton County** affecting 33 acres. Receiving streams: Bald Eagle Creek to Susquehanna River. Application received May 27, 1999.

## **APPLICATIONS RECEIVED UNDER SECTION 401: FEDERAL WATER POLLUTION CONTROL ACT**

### **ENCROACHMENTS**

The following Dam Safety and Encroachment permit applications, requests for Environmental Assessment approval and requests for water quality certification have been received by the Department of Environmental Protection (Department). Section 401(a) of the Federal Water Pollution Control Act (33 U.S.C.A. § 1341(a)) requires the State to certify that the involved projects will not violate the applicable provisions of 33 U.S.C.A. §§ 1311—1313, 1316 and 1317, as well as relevant State requirements. Initial requests for 401 certification will be published concurrently with the permit application. Persons objecting to approval of a request for certification under section 401 or to the issuance of a Dam Safety or Encroachment Permit or the approval of Environmental Assessments must submit comments, suggestions or objections within 30 days of the date of this notice as well as questions to the office noted above the application.

## **Applications received under the Dam Safety and Encroachments Act (32 P. S. §§ 693.1—693.27) and section 302 of the Flood Plain Management Act (32 P. S. § 679.302) and requests for certification under section 401 of the Federal Water Pollution Control Act.**

*Southeast Regional Office: Program Manager, Water Management Program, Lee Park, Suite 6010, 555 North Lane, Conshohocken, PA 19428.*

**E15-621. Encroachment. Vaugh & Sons, Inc.**, 347 E. Conestoga Rd., Wayne, PA 19037. To place fill in a de minimis 0.04 acre of wetland which is in the watershed of a tributary of Crum Creek for the purpose of enhancing a yard area for a residential dwelling. The site is located in Fitzpatrick Subdivision lot number 7 approximately 500 ft. south of the intersection of Mill Road and Evergreen Lane. (Valley Forge, PA Quadrangle N: 4.00-inches; W: 16.5-inches) in Willistown Township, **Chester County**.

**E09-788. Encroachment. Doylestown Township**, 425 Wells Rd., Doylestown, PA 18901. To construct and maintain an 8-foot wide, 5,500 foot long macadam bike and hike path adjacent to the 100 year floodway fringe of the Neshaminy Creek impacting 0.55 acre of wetlands. The site is located along the Neshaminy Creek, in the vicinity of Wells Road and Lower State Road (Doylestown, PA Quadrangle, N: 5.75 inches; W: 3.5 inches) in Doylestown Township, **Bucks County**.

**E23-383. Encroachment. Sunoco, Inc.**, Ten Penn Center, 1801 Market Street, Philadelphia, PA 19103-1699. To install and maintain two 24-inch petroleum pipelines across Exceptional Value (EV) Palustrine open water/emergent mixed wetlands. This work is associated with the Terminal One Expansion Project at the Philadelphia International Airport. Wetland disturbance will be avoided by utilizing directional drilling techniques. The project is located just north of the Philadelphia International Airport, between SEPTA High Speed Line right-of-way and Ramp A which connects Industrial Highway (S.R. 0291) to Interstate 95 (Lansdowne, PA USGS Quadrangle N: 0.5 inch, W: 0.7 inch) in Tinicum Township, **Delaware County**.

**E51-179. Encroachment. City of Philadelphia**, Division of Aviation, Terminal E, Philadelphia International Airport, Philadelphia, PA 19153. To construct and maintain commuter Terminal F and associated 38 passenger boarding gates, aircraft apron, taxi lanes and taxiways in the 100 year floodplain of the Delaware River, located north of existing Terminal E at the Philadelphia International Airport (Philadelphia, PA-NJ Quadrangle N: 15.5 inches; W: 1.3 inches) in the City and **County of Philadelphia**.

*Northeast Regional Office: Soils and Waterways Section, 2 Public Square, Wilkes-Barre, PA 18711-0790, (570) 826-2511.*

**E40-526. Encroachment. John T. Timko**, 788 East Main Street, Weatherly, PA 18255. To construct and maintain a road crossing of a tributary to Big Wapwallopen Creek (locally known as Yeager Creek) (CWF), consisting of a 15.1-foot × 4.8-foot galvanized box culvert and including the placement of fill in a de minimis area of wetlands equal to 0.02 acre, for the purpose of providing access from Brandywyn Drive to a 16.2-acre single residential lot. The project was previously authorized by Permit No. E40-428, which authorized a 14.8-foot × 4.8-foot aluminum box culvert. The project is located on



Lot 19 of the Fox Run Subdivision, approximately 0.5 mile southeast of the intersection of S. R. 2045 and S. R. 3010 (Freeland, PA Quadrangle N: 19.1 inches; W: 8.1 inches), Wright Township, **Luzerne County** (Baltimore District, U. S. Army Corps of Engineers).

*Southcentral Regional Office: Section Chief, Water Management Program, Soils and Waterways Section, 909 Elmerton Avenue, 2nd Floor, Harrisburg, PA 17110, (717) 705-4707.*

**E05-276.** Encroachment. **Bedford Boro Municipal Authority**, 244 W. Penn Street, Bedford, PA 15522. To construct and maintain an effluent pumping station and associated sewer line along the left bank floodway and floodplain of Shobers Run (HQ-CWF) located just upstream of U. S. Route 30 Bridge (Everett West, PA Quadrangle N: 3.0 inches; W: 16.18 inches) in Bedford Borough, **Bedford County**.

**E21-293.** Encroachment. **Kurt Williams**, 3830 Lisburn Rd., Mechanicsburg, PA 17055. To construct and maintain a 10-inch diameter by 125 feet poly vinyl chloride intake pipe and intake headwall along the left bank and floodway of the Yellow Breeches Creek (CWF) to irrigate a property at 3830 Lisburn Road, to maintain existing and future vegetative landscaping, lawns, trees, maintain formal and informal garden areas, and to maintain water levels in and provide maintenance for several ponds located on the property. The intake will be located just upstream of the LR 21051 bridge (Lemoyne, PA Quadrangle N: 9.5 inches; W: 6.9 inches) in Lower Allen Township, **Cumberland County**.

*Northcentral Region: Water Management, Soils and Waterways Section, F. Alan Sever, Chief, 208 West Third St., Suite 101, Williamsport, PA 17701.*

**E14-349.** Encroachment. **PA Dept. of Transportation**, 1924-30 Daisy St., Clearfield, PA 16830. To construct and maintain two 60-inch reinforced concrete pipes (RCP), 579-feet and 907-feet, culverts 1 and 2, respectively; construct four permanent stormwater management basins; construct a temporary stream crossing with one 60-inch and six 48-inch corrugated metal pipes; modify an existing 30-foot span prestressed concrete box beam bridge; remove 0.006 acre of PEM wetlands adjacent to Waddle Creek and remove 0.184 acre of PEM wetlands along Ghaner Road. Culvert 1 (60-inch RCP) is located along S. R. 6220 Sta. 980+50, Segment 270; its upstream end is 2,651.5 feet from the confluence and its downstream end is 2,038.7' from the confluence. Culvert 2 (60-foot RCP) is located at Ramp D Sta. 318+00, Segment 21 and Ramp E Sta. 420+70, Segment 61; its upstream end is 1,345.1 feet from the confluence and its downstream end is 431.4 feet from the confluence. Culverts 1 and 2 are located in the Scotia Road interchange area and will flow into Waddle Creek. The four permanent stormwater management basin locations are as follows: Basin 6 is located within the inner loop of Ramp E, Sta. 974+00 Lt., 1,524 feet from the confluence; Basin 7 is located along existing S. R. 322 at Stevenson Road, Sta. 961+70 Lt., 332 feet from the confluence; Basin 8 is located along S. R. 6220 at ramps B & C, Sta. 974+00 Rt., 1,980 feet from the confluence; and Basin 9 is located along S. R. 6220 at ramps D & E, Sta. 970+00 Lt., 1,357 feet from the confluence. Temporary stream crossing no. 1 is located at approximate Sta. 203+00 and crosses Waddle Creek. Structure 323 is located along S. R. 3042 Sta. 203+00 and has a clear span of 30', an underclearance of 7.5 feet with an effective underclearance of 6.5 feet. (Julian, PA Quadrangle N: 12.0 inches; W: 5.8 inches). The project proposes to permanently impact 1,486 linear

feet of an UNT to Waddle Creek; permanently impact 30 linear feet of Waddle Creek; temporarily impact 135 linear feet of Waddle Creek, that has been classified as HQ-CWF; and permanently impact 0.190 acre of wetland, classified as PEM.

*Northwest Regional Office: Soils and Waterways Section, 230 Chestnut Street, Meadville, PA 16335-3481, (814) 332-6942.*

**E10-304.** Encroachment, **Marion Township**, 23 Creek Bottom Road, Harrisville, PA 16038. To remove the existing White Oak Bridge and to install and maintain a 14-foot-wide by 7.25-foot-high steel pipe arch culvert in North Branch Slippery Rock Creek (CWF) on T-477 (White Oak Road) approximately 1 mile east of SR 0008 (Barkeyville, PA Quadrangle N: 7.5 inches; 14.3 inches) located in Marion Township, **Butler County**.

**E20-479.** Encroachment, **DCNR—Region 2 Park Office**, 195 Park Road, P. O. Box 387, Prospect, PA 16052-0387. To place and maintain fill in approximately 0.6 acre of Pymatuning Reservoir to expand the existing parking and waterfowl/fish feeding area at the Linesville Spillway in Pymatuning State Park approximately 2.05 miles south of the intersection of SR 0006 and SR 3011 in the Borough of Linesville (Linesville, PA Quadrangle N: 1.0 inch; W: 9.0 inches) located in Pine and North Shenango Townships, **Crawford County**.

**E20-480.** Encroachment, **Meadville Area Industrial Comm.**, 18257 Industrial Drive, Meadville, PA 16335. To remove two existing 48-inch-diameter corrugated metal pipe culverts and to construct and maintain a reinforced concrete box culvert having a span of 10 feet and a rise of 4 feet on Painted Road across McMichael Run (WWF) for the initial phase of the Keystone Regional Industrial Park. The project is located approximately 800 feet north of the intersection of SR 3004 (Adamsville Road) and Painted Road at Halls Corners (Geneva, PA Quadrangle N: 4.5 inches; W: 15.5 inches) located in Greenwood Township, **Crawford County**.

#### ENVIRONMENTAL ASSESSMENT

**The following Environmental Assessment and request for Water Quality Certification are being processed under §§ 105.12(a)(16) and 105.15(b), restoration activities undertaken and conducted under a restoration plan approved by the Department.**

*Northwest Regional Office: Soils and Waterways Section, 230 Chestnut Street, Meadville, PA 16335-3481, (814) 332-6942.*

**EA10-011NW.** Environmental Assessment, **Bio Most, Inc.**, 338 Glen Eden Road, Rochester, PA 15074. To remove approximately 20,000 cubic yards of mine refuse/gob which was placed adjacent to Seaton Run (WWF); locally known as Murrin Run, and within the Floodway of this tributary to Seaton Run and to revegetate the riparian corridor. This project is part of a restoration effort to improve water quality within the Slippery Rock Creek Watershed. This project will include the use of BDWM-GP-8, temporary road crossing, (GP081000607) to provide access across this tributary to Seaton Creek. The project is located approximately 4,000 feet southwest of the intersection of S. R. 0308 and Erico Road (Eau Claire, PA Quadrangle N: 1.2 inches; W: 16.8 inches) located in Venango Township, **Butler County**.



## WATER ALLOCATIONS

**Applications received under the act of June 24, 1939 (P. L. 842, No. 365) (32 P. S. §§ 631—641) relating to the acquisition of rights to divert waters of this Commonwealth.**

*Southwest Regional Office: Regional Manager; Water Supply Management, 400 Waterfront Drive, Pittsburgh, PA 15222-4745, (412) 442-4000.*

**WA4-1004.** Water Allocation. **Conway Borough Municipal Authority**, PA 15716. The applicant is requesting the right to purchase 367,200 gallons per day from the Ambridge Water Authority, **Beaver County**.

**WA2-131B.** Water Allocation. **Pittsburgh Water & Sewer Authority**, 441 Smithfield Street, Pittsburgh, PA 15222. The applicant is requesting a subsidiary permit to buy from the Pennsylvania American Water Company on an emergency basis.

## ACTIONS

### FINAL ACTIONS TAKEN UNDER THE PENNSYLVANIA CLEAN STREAMS LAW AND THE FEDERAL CLEAN WATER ACT

[National Pollution Discharge Elimination System Program (NPDES)]

#### DISCHARGE OF CONTROLLED INDUSTRIAL WASTE AND SEWERAGE WASTEWATER

##### (Part I Permits)

The Department of Environmental Protection (Department) has taken the following actions on previously received permit applications and requests for plan approval and has issued the following significant orders.

Persons aggrieved by this action may appeal, under section 4 of the Environmental Hearing Board Act (35 P. S. § 7514), and 2 Pa.C.S. §§ 501—508 and 701—704 (relating to the Administrative Agency Law), to the Environmental Hearing Board, Second Floor, Rachel Carson State Office Building, 400 Market Street, P. O. Box 8457, Harrisburg, PA 17105-8457, (717) 787-3483. TDD users may contact the Board through the Pennsylvania Relay Service, (800) 654-5984. Appeals must be filed with the Environmental Hearing Board within 30 days of receipt of written notice of this action unless the appropriate statute provides a different time period. Copies of the appeal form and the Board's rules of practice and procedure may be obtained from the Board. The appeal form and the Board's rules of practice and procedure are also available in braille or on audiotape from the Secretary to the Board at (717) 787-3483. This paragraph does not, in and of itself, create any right of appeal beyond that permitted by applicable statutes and decisional law.

**Actions under The Clean Streams Law (35 P. S. §§ 691.1—691.1001).**

*Southeast Regional Office: Regional Water Management Program Manager, Lee Park, Suite 6010, 555 North Lane, Conshohocken, PA 19428, (610) 832-6130.*

**WQM Permit No. 0999414.** Sewerage. **Chalfont-New Britain Township Joint Sewer Authority**, 1645 Upper State Road, Doylestown, PA 18901. Approval for the

replacement of the existing chlorine disinfection system with UV light disinfection system located in Doylestown Township, **Bucks County**.

**NPDES Permit No. PA0057011, Amendment No. 1** Sewage. **Thornbury Township**, 8 Township Drive, Cheyney, PA 19319-1019. Amendment to increase the flow for the Bridlewood STP located in Thornbury Township, **Chester County** to Radley Run.

**NPDES Permit No. PA0040576.** Sewage. **Valleybrook Homeowner's Association, Inc.**, P. O. Box 394, Chester Heights, PA 19017, is authorized to discharge from a facility located in Chester Heights Borough, **Delaware County** into West Branch Chester Creek.

**NPDES Permit No. PA0057673.** Sewage. **Candlewyck Estates Homeowner's Association**, 5022 Fernwood Avenue, Egg Harbor, NJ 08234, is authorized to discharge from a facility located at Candlewyck Estates STP, Route 29 and Knight Road, Green Lane, PA 18054, located at Marlborough Township, **Montgomery County** into an unnamed tributary to Perkiomen Creek.

*Northeast Regional Office: Water Management Program Manager, 2 Public Square, Wilkes-Barre, PA 18711-0790, (570) 826-2511.*

**Permit No. 4598407.** Sewerage. **Penn Estates Utilities Inc.**, 503 Hallet Road, East Stroudsburg, PA 18301. Permit to expand existing sewage treatment plant, located in Stroud Township, **Monroe County**.

**Permit No. 4899401.** Sewerage. **Sovereign Bank**, 102 West Main Street, Bath, PA 18014. Permit to construct a sewage treatment facility to serve a single family residence, located in Lower Saucon Township, **Northampton County**.

**NPDES Permit No. PA-0063924.** Sewerage. **Commonwealth of Pennsylvania, Department of Conservation and Natural Resources**, Delaware Canal State Park, 11 Lodi Hill Road, Upper Black Eddy, PA 18972-9540, is authorized to discharge from a facility located in Williams Township, **Northampton County**, to Delaware River.

*Northwest Regional Office: Regional Water Management Program Manager, 230 Chestnut Street, Meadville, PA 16335-3481, (814) 332-6942.*

**WQM Permit No. 4399406.** Sewerage. **Harvey Byler and Tracy L. Deems SRSTP**, 106 Bend Rd., New Wilmington, PA 16142. Construction of Harvey Byler and Tracy L. Deems SRSTP located in Wilmington Township, **Mercer County**.

**NPDES Permit No. PA0101010.** Sewage. **Extendicare Homes, Inc., dba Abington Crest Nursing Center**, 1267 South Hill Road, Erie, PA 16509, is authorized to discharge from a facility located in Summit Township, **Erie County** to an unnamed tributary to Walnut Creek.

**NPDES Permit No. PA0209961.** Sewage. **Hill's Family Campground**, 6300 Sterrettania Road, Fairview, PA 16415, is authorized to discharge from a facility located in McKean Township, **Erie County** to an unnamed tributary to Bear Run.

**NPDES Permit No. PA0027367, Amendment No. 1.** Sewage. **Greenville Sanitary Authority**, 183 Hamburg Road, Greenville, PA 16125, is authorized to discharge from a facility located in Hempfield Township, **Mercer County** to the Shenango River.

**NPDES Permit No. PA0222836.** Sewage, **Harvey Byler and Tracy L. Deems**, 106 Bend Rd., New Wilmington, PA 16142, is authorized to discharge from a

facility located in Wilmington Township, **Mercer County** to Unnamed Tributary to the West Branch of Little Neshannock Creek.

---

### INDIVIDUAL PERMITS

#### (PAS)

The following NPDES Individual Permits for discharges of stormwater from construction activities have been issued.

*Southeast Regional Office: Regional Water Management Program Manager, Lee Park, Suite 6010, 555 North Lane, Conshohocken, PA 19428-2233, (610) 832-6130.*

<i>NPDES Permit No.</i>	<i>Applicant Name and Address</i>	<i>County and Municipality</i>	<i>Receiving Stream</i>
PAS10-G349	Battenkill Properties of PA, LTD 322 Kennett Pike, P. O. Box 895 Mendenhall, PA 19357	West Brandywine and Wallace Townships Chester County	Indian Run
PAS10-G364	Morgan Brothers Builders, Inc. 288 Lancaster Avenue P. O. Box 1074 Frazer, PA 19355	East Vincent Township Chester County	Unnamed Tributary to French Creek
PAS10-T016-R	The Cutler Group, Inc. P. O. Box 629 Horsham, PA 19044	Montgomery Township Montgomery County	Park Creek

### INDIVIDUAL PERMITS

#### (PAR)

---

#### Approvals to Use NPDES and/or Other General Permits

---

The following parties have submitted Notices of Intent (NOIs) for Coverage under (1) General NPDES Permit(s) to discharge wastewater into the surface waters of this Commonwealth. The approval for coverage under these general NPDES permits is subject to applicable effluent limitations, monitoring, reporting requirements and other conditions set forth in the general permit; (2) General Permit(s) for Beneficial Use of Sewage Sludge or Residential Septage by Land Application in Pennsylvania. The approval of coverage for land application of sewage sludge or residential septage under these general permits is subject to pollutant limitations, pathogen and vector attraction reduction requirements, operational standards, general requirements, management practices and other conditions set forth in the respective general permit. The Department of Environmental Protection approves the following coverages under the specified General Permit.

The EPA Region III Regional Administrator has waived the right to review or object to this permit action under the waiver provision: 40 CFR 123.24.

The application and related documents, effluent limitations, permitting requirements and other information are on file and may be inspected and arrangement made for copying at the contact office noted.

*List of NPDES and/or other General Permit Type*

PAG-1	General Permit For Discharges From Stripper Oil Well Facilities
PAG-2	General Permit For Discharges of Stormwater From Construction Activities
PAG-3	General Permit For Discharges of Stormwater From Industrial Activities
PAG-4	General Permit For Discharges From Single Residence Sewage Treatment Plant
PAG-5	General Permit For Discharges From Gasoline Contaminated Ground Water Remediation Systems
PAG-6	General Permit For Wet Weather Overflow Discharges From Combined Sewer Systems
PAG-7	General Permit For Beneficial Use of Exceptional Quality Sewage Sludge By Land Application
PAG-8	General Permit For Beneficial Use of Non-Exceptional Quality Sewage Sludge by Land Application to Agricultural Land, Forest, a Public Contact Site or a Land Reclamation Site
PAG-9	General Permit For Beneficial Use of Residential Septage By Land Application to Agricultural Land, Forest or a Land Reclamation Site

*General Permit Type—PAG-2**Facility Location**County and Municipality**Permit No.**Applicant Name and Address**Receiving Stream or Body of Water**Contact Office and Telephone No.*

<i>County and Municipality</i>	<i>Permit No.</i>	<i>Applicant Name and Address</i>	<i>Receiving Stream or Body of Water</i>	<i>Contact Office and Telephone No.</i>
Lehigh County Upper Saucon Township	PAR10Q123	Upper Saucon Township Bernard Rodgers 5500 Camp Meeting Rd. Center Valley, PA 18034	Saucon Cr.	Lehigh CD (610) 391-9583
Schuylkill County Walker Township and W. Penn Township	PAR105782	ICI Explosives, USA, Inc. ICI Americas Inc. Copperhead Chemical 1 River Road Tamaqua, PA 18252	Little Schuylkill River	Schuylkill CD (570) 622-3742
East Caln Township Chester County	PAR10-G317	PA DOT 200 Radnor Chester Rd. St. Davids, PA	East Branch Brandywine Creek	Suite 6010, Lee Park 555 North Lane Conshohocken, PA 19428 (610) 832-6130
Downingtown Borough Chester County	PAR10-G322	Pennfield P. O. Box 98 Chadds Ford, PA 19317	East Branch Red Clay Creek	Suite 6010, Lee Park 555 North Lane Conshohocken, PA 19428 (610) 832-6130
Radnor Township Delaware County	PAR10-J143	G & D Developers 315 Langford Rd. Broomall, PA 19008	Meadowbrook Run	Suite 6010, Lee Park 555 North Lane Conshohocken, PA 19428 (610) 832-6130
Chadds Ford Borough Concord Township Delaware County	PAR10-J153	PA DOT 200 Radnor Chester Rd. St. Davids, PA	West Branch Chester Creek	Suite 6010, Lee Park 555 North Lane Conshohocken, PA 19428 (610) 832-6130
Lower Moreland Township Montgomery County	PAR10-T507	Fred Betz and Sons, Inc. 670 Knowles Ave. Southampton, PA	Huntingdon Valley Creek	Suite 6010, Lee Park 555 North Lane Conshohocken, PA 19428 (610) 832-6130
City of Philadelphia Philadelphia County	PAR10-5324	Pine Meadows Associates 111 Pheasant Hill Dr. Philadelphia, PA	Municipal Storm Sewer	Suite 6010, Lee Park 555 North Lane Conshohocken, PA 19428 (610) 832-6130
Butler County Cranberry Township	PAR10E088	Cranberry Commons Joint Venture 215 Executive Drive Cranberry Township, PA 16066	Brush Creek	Butler Conservation Dist. 122 McCune Drive Butler, PA 16001-6501
Butler County Cranberry Township	PAR10E098	Home Depot USA 3096 Hamilton Boulevard South Plainfield, NJ 07080	Unnamed Tributary to Brush Creek	Butler Conservation Dist. 122 McCune Drive Butler, PA 16001-6501
Butler County Slippery Rock Township	PAR10E100	DEP Bureau of Abandoned Mine Reclamation, P. O. Box 8476 Harrisburg, PA 17105-8476	Unnamed Tributary to Long Run	Butler Conservation Dist. 122 McCune Drive Butler, PA 16001-6501
Butler County Cranberry Township	PAR10E101	Windwood Heights Plan of Lots Hopeview Partners 241 Emmet Road Wexford, PA 15090	Kaufman Run	Butler Conservation Dist. 122 McCune Drive Butler, PA 16001-6501
Butler County Middlesex Township	PAR10E102	Pheasant Ridge Golf Course 6065 Pittman Road Gibsonia, PA 16044	Unnamed Tributary to Bull Creek	Butler Conservation Dist. 122 McCune Drive Butler, PA 16001-6501
Butler County Cranberry Township	PAR10E104	SR 228 Widening Woodmont Corporation 6500 W. Freeway Suite 900 Fort Worth, TX 76116-2190	Unnamed Tributary to Brush Creek	Butler Conservation Dist. 122 McCune Drive Butler, PA 16001-6501

<i>Facility Location County and Municipality</i>	<i>Permit No.</i>	<i>Applicant Name and Address</i>	<i>Receiving Stream or Body of Water</i>	<i>Contact Office and Telephone No.</i>
Butler County Adams Township	PAR10E107	Mars Area School District 545 Rt. 228 Mars, PA 16046	Unnamed Tributary to Breakneck Creek	Butler Conservation Dist. 122 McCune Drive Butler, PA 16001-6501
Lawrence County Pulaski Township	PAR103733	Kent and Darrell Mitcheltree Mitcheltree Brothers Sawmill P. O. Box 322, Rt. 551N Pulaski, PA 16143	Unnamed Tributary to Buchanan Run	Lawrence Cons District Lawrence Co. Gov't Center 430 Court Street New Castle, PA 16101-3593
<i>General Permit Type—PAG-3</i>				
<i>Facility Location County and Municipality</i>	<i>Permit No.</i>	<i>Applicant Name and Address</i>	<i>Receiving Stream or Body of Water</i>	<i>Contact Office and Telephone No.</i>
Bucks County Falls Township	PAR800090	Joseph T. Moffitt, Regional Manager Parsec, Inc. East Cabot Boulevard Flynn Industrial Park Langhorne, PA 19047	Unnamed Tributary to Rock Run	Southeast Region Water Management 555 North Lane Conshohocken, PA 19428 (610) 832-6130
Cranberry Township Butler County	PAR808368	CNF Transportation/Emery Worldwide Airlines—J57 51 Penn Wood Place Cranberry Township, PA 15086	Unnamed Tributary to Brush Creek	Northwest Region Water Management 230 Chestnut St. Meadville, PA 16335-3481
<i>General Permit Type—PAG-4</i>				
<i>Facility Location County and Municipality</i>	<i>Permit No.</i>	<i>Applicant Name and Address</i>	<i>Receiving Stream or Body of Water</i>	<i>Contact Office and Telephone No.</i>
Allegheny County Forward County	PAG046182	Danner Doak P. O. Box 334 Elizabeth, PA 15037	Unnamed Tributary to the Monongahela River	Southwest Regional Office: Water Management Program Manager 400 Waterfront Drive Pittsburgh, PA 15222-4745 (412) 442-4000
<i>General Permit Type—PAG-7</i>				
<i>Facility Location County and Municipality</i>	<i>Permit No.</i>	<i>Applicant Name and Address</i>	<i>Receiving Stream or Body of Water</i>	<i>Contact Office and Telephone No.</i>
Pike County Westfall Township	PAG07-2201	Pike County Environmental, Inc. P. O. Box 127 Matamoras, PA 18336	N/A	Northeast Regional Office 2 Public Square Wilkes-Barre, PA 18711-0790 (570) 826-2511

**SEWAGE FACILITIES ACT  
PLAN APPROVAL**

**Plan Revision Approval granted June 18, 1999,  
under the Pennsylvania Sewage Facilities Act (35  
P. S. §§ 750.1—750.20).**

*Regional Office: Water Management Program Manager,  
Southcentral Region, 909 Elmerton Avenue, Harrisburg,  
PA 17110-8200.*

*Location: Lorne J. Bowser Subdivision, Single Family  
Residence, West St. Clair Township, Bedford County.*

Approval of a revision to the Official Plan of **West St. Clair Township, Bedford County**. Project involves construction of a small flow treatment facility to serve one new single family residence, with sewage flows of 400 gpd. Located along Township Route 591, 1/2 mile north of its intersection with State Route 56. Treated effluent is to be discharged into an unnamed tributary to Barefoot Run, which is classified as a warm water fishery. Barefoot Run is a tributary to Dunning's Creek.

Required NPDES permits or water management permits must be obtained in the name of the owner.

## SAFE DRINKING WATER

### Actions taken under the Pennsylvania Safe Drinking Water Act (35 P. S. §§ 721.1—721.17).

*Southeast Regional Office: Sanitarian Regional Manager, Lee Park, Suite 6010, 555 North Lane, Conshohocken, PA 19428-2233, (610) 832-6130.*

**Permit No. 1596506.** Public water supply. **Phillips Mushroom Farms**, 1011 Kaolin Road, Kennett Square, PA 19348. A permit has been issued to Phillips Mushroom Farms for the construction of Well Nos. PW2 and PW3 to serve the 70 onsite residents of the Phillips Mushroom Farms in Kennett Township, **Chester County**.

*Type of Facility:* Public Water Supply System

*Consulting Engineer:* Tetra Tech, Inc., P. O. Box 567, West Chester, PA 19381

*Permit to Construct Issued:* June 10, 1999

*Northeast Regional Office: Sanitarian Regional Manager, 2 Public Square, Wilkes-Barre, PA 18711-0790, (717) 826-2511.*

**Permit No. 6498502.** Public water supply. **PC Realty/Bethany Village**, RR 5, Box 170, Bethany, PA 18431, Laurie Aladovitz, CEO. This proposal involves the construction of a new wellhouse, with appurtenances (that is, meter, check valves, disinfection system, and the like) and modifications to the upper well terminus and existing storage facility. Construction permit issued on May 17, 1999.

**Permit No. 3999502.** Public water supply. **Nuss Mobile Home Park**, Donald Steffy, Manager, 3632 Old Post Road, Coplay, PA 18037. This proposal involves the injection of a blended phosphates solution into the well water (no. 2, no. 3) prior to disinfection at an existing MHP. It is located in **Lehigh County**. Construction permit issued on May 28, 1999.

**Permit No. 4099501.** Public water supply. **Monroe Bottling Company, Inc.**, 522 North Main Street, P. O. Box 865, Pittston, PA 18640. This proposal involves the addition of bulk water hauling. It is located in Pittston City, **Luzerne County**. Construction permit issued on June 8, 1999.

**Operations Permit** issued to **Jim Thorpe Borough—EastSide (Corrosion Control)**, Jim Thorpe Borough, **Carbon County**.

**Operations Permit** issued to **Jim Thorpe Borough—WestSide Filtration Plant (Corrosion Control)**, Jim Thorpe Borough, **Carbon County**.

**Operation Permit** issued to **PAWC—Crystal Lake System**, Wilkes-Barre City, **Luzerne County**.

*Regional Office: Northcentral Field Operations, Environmental Program Manager, 208 West Third Street, Suite 101, Williamsport, PA 17701.*

**Permit No. MA.** The Department issued a construction permit to **Tiadaghton View Mobile Home Park**, GSP Management Company, P. O. Box 278, King of Prussia, PA 19406, Upper Fairfield Township, **Lycoming County**, for construction of a 2,000 gallon polyethylene finished water storage tank, a 4,000 gallon steel finished water storage tank, two 1 HP (capacity of 19 gpm at 164 feet TDH) booster pumps and related appurtenances.

**Permit No. 1497502.** The Department issued an operation permit to **Rebersburg Water Company**, P. O.

Box 157, Rebersburg, PA 16872, Miles Township, **Centre County**. This permit authorizes operation of well no. 3 and the transmission line.

**Permit No. 5998501.** The Department issued a construction permit to **Wellsboro Municipal Authority**, 28 Crafton Street, Wellsboro, PA 16901, Wellsboro Borough, **Tioga County**, for construction of additional public water supply sources and related appurtenances, including Wooden Shanty Well, World's End Well and Rock Run Surface Water Intake.

**Permit No. WA-59-1007.** Water Allocation. **Borough of Wellsboro** (28 Crafton Street, Wellsboro, PA 16901), Duncan Township, **Tioga County**. Grants the right to relocate the Lower Clark Intake and withdraw an average of 250,000 gallons per day, on an annual average, from Rock Run located in Duncan Township, **Tioga County**.

## LAND RECYCLING AND ENVIRONMENTAL REMEDIATION

Under Act 2, 1995

Preamble 2

**The following final reports were submitted under the Land Recycling and Environmental Remediations Standards Act (35 P. S. §§ 6026.101—6026.908).**

Provisions of Chapter 3 of the Land Recycling and Environmental Remediation Standards Act (act) require the Department of Environmental Protection (Department) to publish in the *Pennsylvania Bulletin* a notice of submission of final reports. A final report is submitted to document cleanup of a release of a regulated substance at a site to one of the act's remediation standards. A final report provides a description of the site investigation to characterize the nature and extent of contaminants in environmental media, the basis for selecting the environmental media of concern, documentation supporting the selection of residential or nonresidential exposure factors, a description of the remediation performed and summaries of sampling methodology and analytical results which demonstrate that the remediation has attained the cleanup standard selected.

For further information concerning the final report, contact the Environmental Cleanup Program Manager in the Department's Regional Office under which the notice of receipt of a final report appears. If information concerning a final report is required in an alternative form, contact the community relations coordinator at the appropriate Regional Office listed. TDD users may telephone the Department through the AT&T Relay Service at (800) 654-5984.

The Department has received the following final reports:

*Southeast Regional Office: Environmental Cleanup Program Manager, Lee Park, Suite 6010, 555 North Lane, Conshohocken, PA 19428, (610) 832-5950.*

**Reiniger Brothers, Inc. and Reiniger Brothers**, Upper Moreland Township, **Montgomery County**. Darryl D. Borrelli, Manko, Gold & Katcher, LLP, Suite 500, 401 City Avenue, Bala Cynwyd, PA 19004, has submitted a Final Report concerning remediation of site soil contaminated with lead, heavy metals and pesticides. The report is intended to document remediation of the site to meet the Statewide health standard.

**Unisys Corp.**, Blue Bell, PA, Whitpain Township, **Montgomery County**. William J. Ponticello, P.G., Penn E & R, Inc., 2755 Bergey Road, Hatfield, PA 19440, has submitted a Final Report concerning remediation of site groundwater contaminated with solvents. The report is intended to document remediation of the site to meet the Statewide health standard.

**Witco Corp.**, Trainer Borough, **Delaware County**. Marc E. Gold, Manko, Gold & Katcher, LLP, Suite 500, 401 City Avenue, Bala Cynwyd, PA 19004, has submitted a Final Report concerning remediation of site soil contaminated with PCBs, lead, heavy metals, solvents, BTEX, petroleum hydrocarbons and polycyclic aromatic hydrocarbons and groundwater, surface water and sediment contaminated with lead, heavy metals, solvents, BTEX, petroleum hydrocarbons and polycyclic aromatic hydrocarbons. The report is intended to document remediation of the site to meet the Statewide health standard.

**Pennsylvania College of Optometry**, City of Philadelphia, **Philadelphia County**. Michael Williams, Clayton Services, Corp., 1201 Bethlehem Pike, Suite 105, North Wales, PA 19454, has submitted a Final Report concerning remediation of site soil contaminated with BTEX, petroleum hydrocarbons and polycyclic aromatic hydrocarbons. The report is intended to document remediation of the site to meet the Statewide health standard.

*Northwest Regional Office: Craig Lobins, Environmental Cleanup Program Manager, 230 Chestnut Street, Meadville, PA 16335, (814) 332-6648.*

**National Forge Company**, Brokenstraw Township, **Warren County**, One Front Street, Irvine, PA 16329, has submitted a Final Report concerning remediation of the site Area of Concern-7 (surface stained soils) contaminated with lead and heavy metals. The report is intended to document remediation of the site to meet the Statewide health standard. A summary of the Final Report was published in the *Warren Times Observer* on April 14, 1999.

## LAND RECYCLING AND ENVIRONMENTAL REMEDIATION

Under Act 2, 1995

Preamble 3

**The Department has taken action on the following plans and reports under the Land Recycling and Environmental Remediation Standards Act (35 P. S. §§ 6026.101—6026.908) and Chapter 250 Administration of Land Recycling Program.**

Provisions of 25 Pa. Code § 250.8 Administration of Land Recycling Program requires the Department of Environmental Protection (Department) to publish in the *Pennsylvania Bulletin* a notice of its final actions on plans and reports. A final report is submitted to document cleanup of a release of a regulated substance at a site to one of the remediation standards of the Land Recycling and Environmental Remediation Standards Act (act). Plans and reports required by provisions of the act for compliance with selection of remediation to a site-specific standard, in addition to a final report, include a remedial investigation report, risk assessment report and cleanup

plan. A remedial investigation report includes conclusions from the site investigation, concentration of regulated substances in environmental media, benefits of reuse of the property, and in some circumstances, a fate and transport analysis. If required, a risk assessment report describes potential adverse effects caused by the presence of regulated substances. A cleanup plan evaluates the abilities of potential remedies to achieve remedy requirements. A final report provides a description of the site investigation to characterize the nature and extent of contaminants in environmental media, the basis for selecting the environmental media of concern, documentation supporting the selection of residential or nonresidential exposure factors, a description of the remediation performed and summaries of sampling methodology and analytical results which demonstrate that the remediation has attained the cleanup standard selected. The Department may approve or disapprove plans and reports submitted. This notice provides the Department's decision and, if relevant, the basis for disapproval.

For further information concerning the plans and reports, contact the Environmental Cleanup Program Manager in the Department's Regional Office under which the notice of the plan or report appears. If information concerning a final report is required in an alternative form, contact the community relations coordinator at the appropriate Regional Office listed. TDD users may telephone the Department through the AT&T Relay Service at (800) 654-5984.

The Department has acted upon the following plans and reports:

*Southeast Regional Office: Environmental Cleanup Program Manager; Lee Park, Suite 6010, 555 North Lane, Conshohocken, PA 19428, (610) 832-5950.*

**Progress Lighting Facility**, City of Philadelphia, **Philadelphia County**. Michael S. Kozar, P.G. and Thomas A. Nowlan, P. E., O'Brien & Gere Engineers, Inc., 1777 Sentry Parkway West, Gwynedd Hall, Suite 302, Blue Bell, PA 19422, have submitted a Final Report concerning remediation of site soils contaminated with PCBs, heavy metals, solvents, BTEX, petroleum hydrocarbons and polycyclic aromatic hydrocarbons and groundwater contaminated with lead, heavy metals, solvents, BTEX, petroleum hydrocarbons and polycyclic aromatic hydrocarbons. The report demonstrated attainment of site-specific standards and was approved by the Department on June 8, 1999.

*Southwest Field Office: John J. Matviya, Environmental Cleanup Program Manager; 400 Waterfront Drive, Pittsburgh, PA 15222-4745, (412) 442-5217.*

**Home Depot, U.S.A.**, Richland Township, **Cambria County**. Home Depot, U.S.A., c/o Katherine E. Lee, Esq., 2455 Paces Ferry Road, NW, Building C, 20th Floor, Atlanta, GA 30339, Paramont Development, c/o Rex McQuaide, Esq., McQuaide Law Offices, 1405 Eisenhower Boulevard, Richland Square No. 1, Suite 200, Johnstown, PA 15904 and Claire G. Quadri, Urban Engineers of Erie, Inc., 502 West 7th Street, Erie, PA 16502, have submitted a final report concerning remediation of site soil contaminated with lead. The final report demonstrated attainment of the site-specific standard and was approved by the Department on May 17, 1999.

**SOLID AND HAZARDOUS WASTE  
OPERATE WASTE PROCESSING OR DISPOSAL  
AREA OR SITE**

**Permits revoked under the Solid Waste Management Act (35 P.S. §§ 6018.101—6018.1003) and regulations to operate solid waste processing or disposal area or site.**

*Southcentral Regional Office: Regional Solid Waste Manager, 909 Elmerton Avenue, Harrisburg, PA 17110-8200, (717) 705-4706.*

**Permit No. 603387. Hoffner Tract Farm, Altoona City Authority,** (20 Greenwood Road, Altoona, PA 16602). This permit has been revoked at the request of the permittee for a site in Catherine Township, **Blair County.** Permit revoked in the Regional Office June 11, 1999.

**Permits issued under the Solid Waste Management Act (35 P.S. §§ 6018.101—6018.1003) and regulations to operate solid waste processing or disposal area or site.**

*Southcentral Regional Office: Regional Solid Waste Program, 909 Elmerton Avenue, Harrisburg, PA 17110, (717) 705-4706.*

**Permit No. 100962. York County Sanitary Landfill, York County Solid Waste and Refuse Authority** (2700 Blackbridge Road, York, PA 17402). Application for change of closure plan for construction of golf course for a site in Hopewell Township, **York County.** Permit issued in the Regional Office June 15, 1999.

**AIR QUALITY  
OPERATING PERMITS**

**General Plan Approval and Operating Permit issued under the Air Pollution Control Act (35 P.S. §§ 4001—4015) and regulations to construct, modify, reactivate or operate air contamination sources and associated air cleaning devices.**

*Southeast Regional Office: Air Quality Program, 555 North Lane, Conshohocken, PA 19428, (610) 832-6242.*

**23-323-003GP: Southco, Inc.** (210 North Brinton Lake Road, Concordville, PA 19014), issued for burn off ovens in Concord Township, **Delaware County.**

*Northeast Regional Office: Air Quality Program, Two Public Square, Wilkes-Barre, PA 17811-0790, (570) 826-2531.*

**40-323-011GP: First Quality Fibers, Inc.** (P. O. Box 518, Hazleton, PA 18201), for construction and operation of a burn off oven in the Humboldt Industrial Park, Hazle Township, **Luzerne County.**

**Administrative Amendment of Operating Permits issued under the Air Pollution Control Act (35 P.S. §§ 4001—4015) and regulations to construct, modify, reactivate or operate air contamination sources and associated air cleaning devices.**

*Southeast Regional Office: Air Quality Program, 555 North Lane, Conshohocken, PA 19428, (610) 832-6242.*

**OP-46-0024: McNeil Consumer Healthcare** (7050 Camp Hill Road, Fort Washington, PA 19428), issued June 10, 1999, for Facility VOCs/NOx RACT in Whitemarsh Township, **Montgomery County.**

**Operating Permits Minor Modification issued under the Air Pollution Control Act (35 P.S. §§ 4001—4015) and regulations to construct, modify, reactivate or operate air contamination sources and associated air cleaning devices.**

*Northeast Regional Office: Air Quality Program, Two Public Square, Wilkes-Barre, PA 17811-0790, (570) 826-2531.*

**40-310037B: American Asphalt & Paving Co.** (500 Chase Road, Shavertown, PA 18708), for minor modification of a stone crushing plant in Plains Township, **Luzerne County.**

**Operating Permits issued under the Air Pollution Control Act (35 P.S. §§ 4001—4015) and regulations to construct, modify, reactivate or operate air contamination sources and associated air cleaning devices.**

*Southeast Regional Office: Air Quality Program, 555 North Lane, Conshohocken, PA 19428, (610) 832-6242.*

**OP-46-0176: A. Talone, Inc.** (318 West Lancaster Avenue, Ardmore, PA 19003), issued June 17, 1999, for operation of a Facility VOC/NOx RACT in Lower Merion Township, **Montgomery County.**

*Southcentral Regional Office: Air Quality Program, 909 Elmerton Avenue, Harrisburg, PA 17110, (717) 705-4702.*

**21-329-001: Naval Inventory Control Point** (P. O. Box 2020, Mechanicsburg, PA 17055), issued June 14, 1999, for five emergency generators in Hampden Township, **Cumberland County.**

*Northcentral Regional Office: Air Quality Program, 208 West Third Street, Suite 101, Williamsport, PA 17701, (570) 327-3637.*

**TVOP-18-00006: CNG Transmission Corp., Leidy Station** (CNG Tower, 625 Liberty Avenue, Pittsburgh, PA 15201), issued June 15, 1999, for operation of a natural gas transmission station in Leidy Township, **Clinton County.**

**TVOP-60-00014: Evangelical Community Hospital** (One Hospital Drive, Lewisburg, PA 17837), issued June 18, 1999, for operation of a hospital/medical/infectious waste incinerator in Kelly Township, **Union County.**

**TVOP-59-00011: Soldiers and Sailors Memorial Hospital** (32—36 Central Avenue, Wellsboro, PA 16901), issued June 16, 1999, for operation of a hospital/medical/infectious waste incinerator in Wellsboro, **Tioga County.**

**TVOP-53-00011: Charles Cole Memorial Hospital** (US Route 6 East, RR 1, Box 205, Coudersport, PA 16915), issued June 17, 1999, for operation of a hospital/medical/infectious waste incinerator in Coudersport, **Potter County.**

**TVOP-08-00004: Rynone Mfg. Corp., Sayre Plant** (P. O. Box 128, Sayre, PA 18840), issued June 5, 1999, for production of bathroom vanity tops in Sayre Borough, **Bradford County.**

**TVOP-17-00005: Glen-Gery Corp., Bigler Plant** (P. O. Box 338, State Route 970, Bigler, PA 16825), issued June 5, 1999, for production of brick and clay related products in Bradford Township, **Clearfield County.**

**TVOP-59-00008: Tennessee Gas Pipeline Co., Station 315 Wellsboro** (P. O. Box 2511, 1001 Louisiana Street, Houston, TX 77252-2511), issued revised Title V Operating Permit on June 16, 1999, for operation of a

natural gas transmission station, located in Charleston Township, **Tioga County**. The revision of this Title V operating permit is to incorporate the changes to permit conditions pertaining to emissions reporting requirements. The Title V Operating Permit was first issued on March 17, 1997.

#### PLAN APPROVALS

**Minor Modification of Plan Approvals issued under the Air Pollution Control Act (35 P. S. §§ 4001—4015) and regulations to construct, modify, reactivate or operate air contamination sources and associated air cleaning devices.**

*Northcentral Regional Office: Air Quality Program, 208 West Third Street, Suite 101, Williamsport, PA 17701, (570) 327-3637.*

**14-313-038: Rutgers Organics Corp.** (201 Struble Road, State College, PA 16801), on June 10, 1999, to modify a number of plan approval conditions pertaining to a chemical process facility (reduction in required caustic soda concentration in scrubbing solution, modification of sodium hydroxide scrubbing solution content limits from concentration basis to pH basis, increase in allowable condenser coolant temperature, and the like) in College Township, **Centre County**.

**Plan Approvals issued under the Air Pollution Control Act (35 P. S. §§ 4001—4015) and regulations to construct, modify, reactivate or operate air contamination sources and associated air cleaning devices.**

*Southeast Regional Office: Air Quality Program, 555 North Lane, Conshohocken, PA 19428, (610) 832-6242.*

**PA-46-0010B: Montenay Montgomery Ltd Partnership** (1155 Conshohocken Road, Conshohocken, PA 19428), issued June 10, 1999, for the operation of a municipal solid waste combustor in Plymouth Township, **Montgomery County**.

**PA-23-0047A: Degussa Corp.** (1200 West Front Street, Chester, PA 19013), issued June 10, 1999, for operation of a spray dryer in City of Chester, **Delaware County**.

**PA-23-0041: Tosco Refining Co.** (4101 Post Road, Trainer, PA 19061), issued June 15, 1999, for operation of a storage tank in Trainer Borough, **Delaware County**.

**PA-15-0086: Bakery Feeds** (97 West Brook Drive, Honey Brook, PA 19344), issued June 17, 1999, for operation of a bakery waste recycling operation in West Brandywine Township, **Chester County**.

*Northeast Regional Office: Air Quality Program, Two Public Square, Wilkes-Barre, PA 17811-0790, (570) 826-2531.*

**54-320-064: Rest Haven Nursing Home** (401 University Drive, Schuylkill Haven, PA 17972), issued June 4, 1999, for construction of a coal fired boiler in North Manheim Township, **Schuylkill County**.

**54-310-010B: Northeastern Power Co.** (P. O. Box 7, McAdoo, PA 18237), issued June 2, 1999, for modification of the fuel preparation plant in Kline Township, **Schuylkill County**.

*Southcentral Regional Office: Air Quality Program, 909 Elmerton Avenue, Harrisburg, PA 17110, (717) 705-4702.*

**22-317-012A: Hershey Foods, Inc.** (100 Crystal A Drive, Hershey, PA 17033-0810), issued June 4, 1999, for

modification of a sugar conveying system controlled by fabric filters at the Hershey Plant in Derry Township, **Dauphin County**.

**36-05015B: Dart Container Corp.** (60 East Main Street, Leola, PA 17540), issued June 11, 1999, for modification of the direct injection foam processing operations at the Leola Plant in Upper Leacock Township, **Lancaster County**.

**Plan Approvals extensions issued under the Air Pollution Control Act (35 P. S. §§ 4001—4015) and regulations to construct, modify, reactivate or operate air contamination sources and associated air cleaning devices.**

*Southeast Regional Office: Air Quality Program, 555 North Lane, Conshohocken, PA 19428, (610) 832-6242.*

**23-313-024C: Degussa Corp.** (1200 West Front Street, Chester, PA 19013), issued June 8, 1999, for operation of a silica manufacturing process in City of Chester, **Delaware County**.

**PA-15-0002B: Quebecor Printing Atglen, Inc.** (Route 372, Lower Valley Road, Atglen, PA 19310), issued June 8, 1999, for operation of a publication rotogravure press in West Sadsbury Township, **Chester County**.

**PA-46-0018A: Brown Printing Co.** (668 Gravel Pike, East Greenville, PA 18041), issued June 15, 1999, for operation of lithographic printing presses in Upper Hanover Township, **Montgomery County**.

**15-320-023: Dopaco, Inc.** (241 Woodbine Road, Downingtown, PA 19335), issued June 15, 1999, for operation of a flexographic printing press in Downingtown Borough, **Chester County**.

**PA-15-0027B: Johnson Matthey, Inc.** (456 Devon Park Drive, Wayne, PA 19087), issued June 15, 1999, for operation of a drum dryer in Tredyffrin Township, **Chester County**.

**PA-15-0027A: Johnson Matthey, Inc.** (456 Devon Park Drive, Wayne, PA 19087), issued June 15, 1999, for operation of a drum dryer dust collector in Tredyffrin Township, **Chester County**.

**15-309-016A: Johnson Matthey, Inc.** (456 Devon Park Drive, Wayne, PA 19087), issued June 15, 1999, for operation of an SCR System No. 1 in Tredyffrin Township, **Chester County**.

**23-313-046: Norquay Technology, Inc.** (800 West Front Street, Chester, PA 19016), issued June 15, 1999, for operation of a specialty chemical process in City of Chester, **Delaware County**.

**09-320-046: Fibermark, Inc.** (45 North Fourth Street, Quakertown, PA 18951), issued June 16, 1999, for operation of a graphic art line no. 1 in Quakertown Borough, **Bucks County**.

**09-320-047: Fibermark, Inc.** (45 North Fourth Street, Quakertown, PA 18951), issued June 16, 1999, for operation of a graphic art line no. 2 in Quakertown Borough, **Bucks County**.

**09-320-050: Superpac, Inc.** (1220 Industrial Boulevard, Upper Southampton, PA), issued June 17, 1999, for operation of a flexographic printing press in Upper Southampton Township, **Bucks County**.

*Southcentral Regional Office: Air Quality Program, 909 Elmerton Avenue, Harrisburg, PA 17110, (717) 705-4702.*



**36-312-002A: Mobil Oil Corp.** (Eight South Main Road, Frazer, PA 19355), issued March 19, 1999, to authorize temporary operation of a bulk gasoline terminal consisting of a three bottom bay loading rack controlled by a vapor combustion unit, covered under this Plan Approval until July 16, 1999, at 1360 Manheim Pike in Manheim Township, **Lancaster County**.

**67-310-053: York Building Products Co., Inc.** (P. O. Box 1708, York, PA 17405), issued March 31, 1999, to authorize temporary operation of stone crushing plants controlled by baghouses, covered under this Plan Approval until July 28, 1999, at the Lincoln Stone Quarry in Jackson Township, **York County**. This source is subject to 40 CFR Part 60, Subpart 000—Standards of Performance for Nonmetallic Mineral Processing Plants.

## MINING

### APPROVALS TO CONDUCT COAL AND NONCOAL ACTIVITIES

Actions on applications under the Surface Mining Conservation and Reclamation Act (52 P. S. §§ 1396.1—1396.19a); the Noncoal Surface Mining Conservation and Reclamation Act (52 P. S. §§ 3301—3326); The Clean Streams Law (35 P. S. §§ 691.1—691.1001); the Coal Refuse Disposal Control Act (52 P. S. §§ 30.51—30.66); The Bituminous Mine Subsidence and Land Conservation Act (52 P. S. §§ 1406.1—1406.21). The final action on each application also constitutes action on the request for 401 water quality certification. Mining activity permits issued in response to the applications will also address the applicable permitting requirements of the following statutes: the Air Quality Control Act (35 P. S. §§ 4001—4015); the Dam Safety and Encroachments Act (32 P. S. §§ 693.1—693.27); and the Solid Waste Management Act (35 P. S. §§ 6018.101—6018.1003).

*Greensburg District Office, R. D. 2, Box 603-C, Greensburg, PA 15601.*

#### Coal Permits Issued

**03960102. Walter L. Houser Coal Co., Inc.** (R. D. 1, Box 434, Kittanning, PA 16201). Permit revised to change land use from wildlife habitat to pastureland at an existing bituminous surface/auger mine located in Sugarcreek Township, **Armstrong County**, affecting 300.8 acres. Receiving streams: unnamed tributary to Snyder Run to Snyder Run. Application received: March 18, 1999. Revision issued: June 14, 1999.

**04890101R. Kerry Coal Company** (R. D. 2, Box 2139, Wampum, PA 16157). Renewal issued for continued reclamation only of a bituminous surface mine located in South Beaver Township, **Beaver County**, affecting 186 acres. Receiving streams: Brush Run to the North Fork to Little Beaver Creek to the Ohio River. Application received: March 29, 1999. Reclamation only renewal issued: June 15, 1999.

**03890116R. Rosebud Mining Company** (R. R. 9, Box 379A, Kittanning, PA 16201-9642). Renewal issued for continued operation and reclamation of a bituminous surface/auger mine located in Perry Township, **Armstrong County**, affecting 174.5 acres. Receiving streams: unnamed tributaries to the Allegheny River. Application received: January 29, 1999. Renewal issued: June 15, 1999.

**30773006R. Chess Coal Company** (R. D. 1, Box 151, Smithfield, PA 15478). Renewal issued for continued operation and reclamation of a bituminous surface mine located in Dunkard Township, **Greene County**, affecting 66.5 acres. Receiving streams: unnamed tributary to

Crooked Run and Dunkard Creek. Application received: April 1, 1999. Renewal issued: June 15, 1999.

**03960105. Amerikohl Mining, Inc.** (202 Sunset Drive, Butler, PA 16001). Revision issued to mine through and relocate a portion of unnamed tributary 2, add sedimentation pond B-1 and associated collection ditches, and include postmining land use for the newly relocated 1.9 acres around unnamed tributary 2, at a bituminous surface/auger mine located in Cowanshannock Township, **Armstrong County**, affecting 501 acres. Receiving streams: unnamed tributaries to Huskins Run and Huskins Run. Application received: April 28, 1999. Revision issued: June 15, 1999.

**03960108. Dutch Run Coal, Inc.** (A02-Box 366, Shelocta, PA 15774). Revision issued to change the land use from forestland to pastureland/land occasionally cut for hay at a bituminous surface/auger mine located in Plumcreek Township, **Armstrong County**, affecting 39.6 acres. Receiving streams: unnamed tributary to Crooked Creek. Application received: April 14, 1999. Revision issued: June 21, 1999.

*Hawk Run District Office, P. O. Box 209, Off Empire Road, Hawk Run, PA 16840.*

**17753050. River Hill Coal Co., Inc.** (P. O. Box 141, Kylertown, PA 16847), renewal of an existing bituminous surface mine-tipple refuse disposal permit in Karthaus Township, **Clearfield County** affecting 642.8 acres. Receiving streams: unnamed tributaries to Saltlick Run, to Saltlick Run, unnamed tributaries to West Branch Susquehanna River, Saltlick Run, Mosquito Creek all to West Branch Susquehanna River. Application received February 25, 1999. Permit issued June 9, 1999.

**17850120. M. B. Energy, Inc.** (250 Airport Road, P. O. Box 1319, Indiana, PA 15701-1319), revision to an existing bituminous surface mine for a change in permit acreage from 902.4 to 924.7 acres, Bell Township, **Clearfield County**. Receiving streams: Haslett Run and two unnamed tributaries to Haslett Run to the West Branch of the Susquehanna River. Application received January 27, 1999. Permit issued June 9, 1999.

**14663003. Power Operating Co., Inc.** (P. O. Box 25, Osceola Mills, PA 16666), major revision to an existing bituminous surface mine permit to apply biosolids (stabilized sewage sludge) to enhance vegetation on a 920 acre site in Rush Township, **Centre County**. Application received September 10, 1999. Permit issued June 10, 1999.

**17980120. R. B. Contracting** (R. D. 1, Box 13, Curwensville, PA 16833), commencement, operation and restoration of a bituminous surface mine permit in Westover Borough, **Clearfield County** affecting 64.1 acres. Receiving streams: unnamed tributary #1 to Chest Creek, Chest Creek. Application received September 10, 1998. Permit issued June 11, 1999.

**17970117. Waroquier Coal Company** (P. O. Box 128, Clearfield, PA 16830), commencement, operation and restoration of a bituminous surface mine permit in Bell Township, **Clearfield County** affecting 36.4 acres. Receiving streams: unnamed tributaries to the West Branch of the Susquehanna River. Application received October 9, 1997. Permit issued June 11, 1999.

**14940101. Power Operating Co., Inc.** (P. O. Box 25, Osceola Mills, PA 16666), major permit modification to apply biosolids (stabilized sewage sludge) to enhance vegetation on an existing bituminous surface mine permit in Rush Township, **Centre County** affecting 522 acres.

Receiving streams: unnamed tributary to Moshannon Creek. Application received November 9, 1998. Permit issued June 18, 1999.

*Knox District Office, P. O. Box 669, Knox, PA 16232*

**37890108. Amerikohl Mining, Inc.** (202 Sunset Drive, Butler, PA 16001). Renewal of an existing bituminous strip and auger operation in Hickory Township, **Lawrence County** affecting 301.0 acres. This renewal is issued for reclamation only. Receiving streams: Two unnamed tributaries to Neshannock Creek, Three unnamed tributaries to Hottenbaugh Creek and one unnamed tributary to Big Run. Application received: March 12, 1999. Permit Issued: May 18, 1999.

**10980109. Ben Hal Mining Company** (389 Irishtown Rd., Grove City, PA 16127). Commencement, operation and restoration of a bituminous strip operation in Muddy Creek Township, **Butler County** affecting 141.2 acres. Receiving streams: Unnamed tributary to Bear Run. Application received: September 15, 1998. Permit Issued: June 4, 1999.

**16940107. RFI Energy, Inc.** (555 Philadelphia, PA 15701). Transfer of an existing bituminous strip operation from C & K Coal Company in Perry Township, **Clarion County** affecting 224.0 acres. Receiving streams: Five unnamed tributaries to Cherry Run. Application received: April 9, 1999. Permit Issued: June 9, 1999.

**24980907. Floyd Mottern Coal, Inc.** (RR, Box 118, Penfield, PA 15849). Commencement, operation and restoration of an incidental coal extraction operation in the City of St. Marys, **Elk County** affecting 3.9 acres. Receiving streams: Unnamed tributary to Elk Creek and Unnamed tributary to South Fork. Application received: December 8, 1998. Permit Issued: June 9, 1999.

*Pottsville District Office, 5 West Laurel Boulevard, Pottsville, PA 17901-2454.*

**13990201. Rossi Excavating Company** (9 West 15th Street, Hazleton, PA 18201), commencement, operation and restoration of a coal refuse reprocessing operation in Banks Township, **Carbon County** affecting 493.0 acres, receiving stream—none. Permit issued June 17, 1999.

**54900101C3. Blackwood, Inc.** (P. O. Box 639, Wind Gap, PA 18091), correction to an existing surface mine operation in Branch and Reilly Townships, **Schuylkill County** affecting 1,847.6 acres, receiving streams—Panther and Swatara Creeks. Correction issued June 18, 1999.

*Greensburg District Office, R. D. 2, Box 603-C, Greensburg, PA 15601.*

*Noncoal Permits Issued*

**03990801. Mary A. Edwards** (R. D. 1, Ford City, PA 16226). Permit issued for commencement, operation and reclamation of a small noncoal (shale) surface mine located in Manor Township, **Armstrong County**, affecting 1.2 acres. Receiving streams: unnamed tributary to the Allegheny River. Application received: March 16, 1999. Permit issued: June 9, 1999.

*Knox District Office, P. O. Box 669, Knox, PA 16232.*

**3175SM3. I. A. Construction Corp.** (P. O. Box 8, Concordville, PA 19331). Transfer of an existing sand and gravel operation from A. Medure Sand & Gravel Co., Inc. in Plain Grove Township, **Lawrence County** affecting 153.0 acres. Receiving streams: Unnamed tributary to Jamison Run and Jamison Run. Application received: March 11, 1999. Permit Issued: June 1, 1999.

*Pottsville District Office, 5 West Laurel Boulevard, Pottsville, PA 17901-2454.*

**15830602C3. Allan A. Myers, Inc. d/b/a Independence Construction Materials** (4042 State Street, P. O. Box 657, Devault, PA 19432), renewal of NPDES Permit No. PA0614203 in Charlestown Township, **Chester County**, receiving stream—unnamed tributary to Pickering Creek. Renewal issued June 16, 1999.

*Hawk Run District Office, P. O. Box 209, Off Empire Road, Hawk Run, PA 16840.*

*Small Noncoal (Industrial Mineral) Permits Issued*

**59990801. Wesley J. Cole** (R. R. 2, Box 328, Middlebury Center, PA 16935), commencement, operation and restoration of a small industrial mineral (topsoil/gravel) permit in Middlebury Township, **Tioga County** affecting 1 acre. Receiving streams: Crooked Creek, tributary to North Ives Run. Application received March 31, 1999. Permit issued June 9, 1999.

*Knox District Office, P. O. Box 669, Knox, PA 16232.*

**43992803. J. J. Cline Excavating** (628 Hadley Road, Greenville, PA 16125). Commencement, operation and restoration of a small noncoal sand and gravel operation in Perry Township, **Mercer County** affecting 10.0 acres. Receiving streams: None. Application received: March 26, 1999. Permit Issued: May 27, 1999.

**20982804. Andrew M. Kosturick** (8565 State Highway 285, Conneaut Lake, PA 16316). Commencement, operation and restoration of a small noncoal sand and gravel operation in East Fallowfield Township, **Crawford County** affecting 5.0 acres. Receiving streams: None. Application received: December 11, 1998. Permit Issued: June 8, 1999.

**Bureau of Deep Mine Safety**

**Request for Variance**

**Tanoma Mining Company, Inc.**

The Bureau of Deep Mine Safety (BDMS) has approved Tanoma Mining Company, Inc.'s request for a variance from the requirements of section 242(c) of the Pennsylvania Bituminous Coal Mine Act at the Tanoma Mine. The following notification contains a summary of this request. A complete copy of the variance request may be obtained from Allison Gaida by calling (724) 439-7469 or from the BDMS web site at <http://www.dep.state.pa.us/dep/deputate/minres/dms/dms.htm>.

*Summary of the request:* Tanoma Mining Company, Inc. requested a variance from section 242(c) of the Pennsylvania Bituminous Coal Mine Act to allow for the common ventilation of belt conveyor entry with other entries at the Tanoma Mine. This proposal accords protections to persons and property substantially equal to or greater than the requirements of section 242(c) of the Pennsylvania Bituminous Coal Mine Act.

The basis for the Bureau's approval is summarized in the following statements:

1. Tanoma's plan provides early warning fire detection by the use of CO detectors and audible alarm over the mine communication system.
2. Tanoma's plan provides a separate, isolated intake escapeway that will be maintained at a higher ventilation pressure than the belt and common entries.
3. Tanoma's plan provides for the belt and common entries to serve as an alternate intake escapeway.

4. There are significant health and safety benefits associated with allowing entries in common with the belt entry. Repair and maintenance work in the belt entry is isolated from other entries. All other terms and requirements of section 242(c) shall remain in effect. This approval applies to all areas developed after May 20, 1998. Continued authorization for operation under the approval is contingent upon compliance with the measures described in Tanoma's approved plan and the following condition. Common entries will only be permitted out by areas where the common entry is at a higher ventilation pressure than the intake escapeway.

### ACTIONS TAKEN UNDER SECTION 401: FEDERAL WATER POLLUTION CONTROL ACT ENCROACHMENTS

The Department of Environmental Protection (Department) has taken the following actions on previously received Dam Safety and Encroachment permit applications, requests for Environmental Assessment approval and requests for Water Quality Certification under section 401 of the Federal Water Pollution Control Act (33 U.S.C.A. § 1341(a)).

Persons aggrieved by this action may appeal, under section 4 of the Environmental Hearing Board Act (35 P. S. § 7514) and 2 Pa.C.S. §§ 501—508 and 701—704 (relating to the Administrative Agency Law) to the Environmental Hearing Board, 400 Market Street, Floor 2, P. O. Box 8457, Harrisburg, PA 17105-8457, (717) 787-3483. TDD users may contact the Board through the Pennsylvania Relay Service, (800) 654-5984. Appeals must be filed with the Environmental Hearing Board within 30 days of receipt of the written notice of this action unless the appropriate statute provides a different time period. Copies of the appeal form and the Board's rules of practice and procedure may be obtained from the Board at (717) 787-3483. This paragraph does not, in and of itself, create any right of appeal beyond that permitted by applicable statutes and decisional law.

**Actions on applications filed under the Dam Safety and Encroachments Act (32 P. S. §§ 693.1—693.27) and section 302 of the Flood Plain Management Act (32 P. S. § 679.302) and sections 5 and 402 of The Clean Streams Law (35 P. S. §§ 691.5 and 691.402) and notice of final action for certification under section 401 of the Federal Water Pollution Control Act (33 U.S.C.A. § 1341(a)).** (Note: Permits issued for Small Projects do not include 401 Certification, unless specifically stated in the description.)

*Southeast Regional Office: Program Manager, Water Management Program, Lee Park, Suite 6010, 555 North Lane, Conshohocken, PA 19428.*

**E51-165.** Encroachment Permit. **CSX Intermodal**, Southern Bell Towers, 301 West Bay Street, Suite 2400, Jacksonville, FL 32202. To perform the following activities at the CSX Intermodal Greenwich Yard Project: 1. To relocate, place fill in and modify approximately 2,520 linear feet of an unnamed tributary to the Delaware River (WWF, MF) and to construct and maintain 2,600 linear feet of trapezoidal open channel whose bottom width varies from 9 to 12 feet. Approximately 540 linear

feet of the existing channel is tidal and the entire proposed channel will be tidal; 2. To place and maintain fill within 6.92 acres of wetland (PEM) to accommodate an intermodal container cargo staging area and railroad tracks; 3. To remove an 18-inch CMP culvert measuring 30 linear feet in length and a 24-inch CMP culvert measuring 50 linear feet in length along the existing channel and to install and maintain approximately 84 linear feet of 8-foot by 6-foot reinforced concrete box culvert along the proposed channel; 4. To regrade and maintain fill associated with the track relocation of various railroad sidings and to install and maintain drainage facilities within the 100-year floodplain of Delaware River. The project is situated in an area south of Interstate 95, north and east of the former Philadelphia Naval Yard, and west of the Delaware River and Columbus Boulevard (a.k.a. Delaware Avenue) (Philadelphia, PA-NJ USGS Quadrangle N: 4.5 inches, W: 4.0 inches) in the City and **County of Philadelphia**. The permittee will construct 6.92 acres of onsite wetland replacement.

*Southcentral Regional Office: Section Chief, Water Management Program, Soils and Waterways Section, 909 Elmerton Avenue, 2nd Floor, Harrisburg, PA 17110, (717) 705-4707.*

**E01-206.** Encroachment. **David LeVan**, 1094 Baltimore Pike, Gettysburg, PA 17325. To remove an existing structure and to (1) construct and maintain 20 linear feet of 57-inch by 38-inch corrugated metal pipe arch in an unnamed tributary to Rock Creek (WWF); (2) maintain a chain link privacy fence across the stream at this location; (3) restore approximately 100 linear feet of channel; and, (4) construct approximately 120 linear feet of a previously filled channel located upstream of the culvert. The site is located east of US 140 (Baltimore Pike) 1.2 miles south of Gettysburg Square (Gettysburg, PA Quadrangle N: 11.6 inches; W: 13.6 inches) in Cumberland Township, **Adams County**. This permit was issued under section 105.13(e) "Small Projects." This permit also includes 401 Water Quality Certification.

**E06-520.** Encroachment. **Upper Tulpehocken Township**, Ken Grimes, P. O. Box H, Strausstown, PA 19559. To remove an existing structure and to construct and maintain an 18-foot x 5 1/2-foot concrete box culvert in the channel of Northkill Creek at a point at Northkill Road (T-704) (Friedensberg, PA Quadrangle N: 2.7 inches; W: 0.6 inch) in Upper Tulpehocken Township, **Berks County**. This permit was issued under section 105.13(e) "Small Projects." This permit also includes 401 Water Quality Certification.

**E22-399.** Encroachment. **HC Partners**, Dennis Goodwin, 1770 E. Market St., York, PA 17402. To impact 0.03 acre of wetlands with a driveway crossing and to excavate an impoundment area within the floodway for construction of a stormwater collection basin in and along a tributary to Beaver Creek (WWF). The Hunt Club residential development is located upstream of Copperstone Road (Harrisburg East, PA Quadrangle N: 8.75 inches; W: 0.75 inch) in Lower Paxton Township, **Dauphin County**. The applicant will provide 0.05 acre of replacement wetlands. Issuance of this permit constitutes approval of the Environmental Assessment for the nonjurisdictional stormwater management embankment proposed at the project site. This permit also includes 401 Water Quality Certification.

*Southwest Regional Office: Soils and Waterways Section, 400 Waterfront Drive, Pittsburgh, PA 15222-4745.*

**E02-1264.** Encroachment. **Port Authority of Allegheny County**, 2235 Beaver Avenue, Pittsburgh, PA

15233-1080. To construct and maintain a reinforced concrete box culvert having a span of 2.43 m (8 feet) and an underclearance of 1.83 m (6 feet) for a distance of approximately 217 m (710 feet), the invert of the box culvert will be depressed a minimum depth of 0.15 m (6 inches), to place and maintain 43 m (140 feet) of gabion mattress inlet protection and 55 m (180 feet) of gabion mattress outlet protection in a tributary to Piney Fork (TSF) for the purpose of permanently stabilizing the stream bank and protecting the rail line. The project is located along the west side of Brightwood Road between its intersections with Munroe Street and Winton Drive (Bridgeville, PA Quadrangle starts at N: 12.6 inches; W: 3.9 inches and ends at N: 13.1 inches; W: 4.1 inches) in the Municipality of Bethel Park, **Allegheny County**.

**E02-1271.** Encroachment. **Public Auditorium Authority of Pittsburgh and Allegheny County**, Regional Resource Center, 425 Sixth Avenue, Suite 1410, Pittsburgh, PA 15219-1819. To construct and maintain a new NFL stadium for the Pittsburgh Steelers Football Team within the floodway fringe of the Ohio River (WWF). The stadium will be located on the north side of North Shore Drive between Stadium Drive West and Allegheny Drive, on the right bank side of the Ohio River at the confluence of the Allegheny River and Monongahela River (Pittsburgh West, PA Quadrangle N: 13.0 inches; W: 2.2 inches) in the City of Pittsburgh, **Allegheny County**.

**E11-272.** Encroachment. **PA Department of Transportation**, 1620 North Juniata Street, Hollidaysburg, PA 16648. To rehabilitate, operate and maintain the existing Inclined Plan Access Bridge having a normal span of 232.0 feet and a minimum underclearance of 35.0 feet across Stony Creek (WWF) and to construct and maintain a temporary causeway and a temporary stream crossing consisting of 14 48-inch pipes in Stony Creek (WWF). The project is located on S. R. 3022, Section 001, Segment 0010, Offset 0000 (Johnstown, PA Quadrangle N: 13.8 inches; W: 7.0 inches) in the City of Johnstown, **Cambria County**.

**E32-399.** Encroachment. To place and maintain fill in 0.19 acre of wetlands (PEM) in an unnamed tributary to McCarthy Run (CWF) for the purpose of construction of a development. The project is located at the intersection of S. R. 286 and S. R. 6422 (Indian Springs Road), (Indiana, PA Quadrangle N: 18.9 inches; W: 8.5 inches) in White Township, **Indiana County**. The permittee shall make a monetary contribution to the National Fish & Wildlife Foundation Pennsylvania Wetland Project.

*Permits Issued and Actions on 401 Certification*

*Northwest Regional Office: Soils and Waterways Section, 230 Chestnut Street, Meadville, PA 16335-3481, (814) 332-6942.*

**E20-475.** Encroachment. **French Creek Recreational Trails, Inc.**, c/o Community Health Services, 747 Terrace Street, Meadville, PA 16335. To construct and maintain a covered bridge having a clear span of approximately 50 feet and an underclearance of 3.5 feet across Van Horne Creek on the former Bessemer and Lake Erie Railroad bed approximately 1,300 feet south of S. R. 322 for use as a bicycle/recreational trail (Geneva, PA Quadrangle N: 21.2 inches; W: 5.4 inches) located in Vernon Township, **Crawford County**.

## SPECIAL NOTICES

### Public Hearing

*Northeast Regional Office: Soils and Waterways Section, 2 Public Square, Wilkes-Barre, PA 18711-0790, (570) 826-2511.*

### NPDES Discharge of Stormwater from Construction Activities

#### Kovatch Enterprises

#### One Industrial Complex

#### Nesquehoning, PA 18240

The Department of Environmental Protection (Department) will hold a public hearing on an individual National Pollution Elimination System (NPDES) permit application No. PAS101321 submitted by Kovatch Enterprises. The application is for discharges of stormwater, from construction activities, to Deep Run and First Hollow Run, both are exceptional value (EV) watersheds and also Dennison Run and Broad Run which are high quality (HQ) watersheds. The construction is related to the proposed Green Acres Industrial Park in Nesquehoning Borough, Carbon County.

The hearing is scheduled for Thursday, August 5 at 7 p.m. in the Nesquehoning Borough Building on West Catawissa Street in Nesquehoning.

The Department is in the final stages of review for the proposal and has received a recommendation for approval from the Carbon County Conservation District. The public hearing will only be held if significant public interest exists. If the Department does not receive comments regarding the proposal during the 30-day comment period, it will be understood that there is no significant interest and the public hearing will be canceled.

To develop an agenda for the hearing, the Department requests that individuals wishing to testify at the hearing submit a written notice of their intent to Kate Crowley, Department of Environmental Protection, Water Management Program, 2 Public Square, Wilkes-Barre, PA 18711. The Department will accept notices up to the day of the hearing.

The Department requests that individuals limit their testimony to 10 minutes so that all individuals have the opportunity to testify. Written copies of oral testimony are requested. Relinquishing of time will not be allowed. All individuals attending the hearing will have the opportunity to testify if they so desire, however, individuals who preregister to testify will be given priority.

Persons with a disability who wish to testify and require an auxiliary aid, service or other accommodation should contact Richard Shudak of DEP at (570) 826-2060 or the Pennsylvania AT&T relay service at (800) 654-5984 (TDD) to discuss how the Department can accommodate their needs.

Those unable to attend the hearing can submit written testimony or comment to the Department until August 12, 1999.

The NPDES permit application is available for review at the Northeast Regional Office, 2 Public Square in Wilkes-Barre. Appointments for scheduling a review can be made by calling DEP's regional Records Management Section at (570) 826-2511. The permit application is also for review at the Carbon County Conservation District, 5664 Interchange Road, Lehighton, PA 18235-5114.

**Availability of Grants for the Remediation of Waste Tire Piles in Pennsylvania Under the Waste Tire Remediation Grant Program for Municipalities for Fiscal Year 1999/2000**

The Department of Environmental Protection (Department) hereby announces the availability of grants through the Waste Tire Recycling Act of 1996 (Act 190) for Fiscal Year 1999/2000 for the remediation of waste tire piles in Pennsylvania. The Waste Tire Remediation Grant Program for Municipalities for Fiscal Year 1999/2000 provides a grant program, which is funded through the general fund. The grants are limited to only those municipalities having a waste tire pile containing 5,000 or more waste tires.

Only municipalities are eligible to participate and receive funding. To be considered for a grant, a municipality must propose to remediate a waste tire pile on the Department's list of priority waste tire piles or piles containing 5,000 or greater waste tires. (Copies of the list of priority waste tire piles is available from the Division of Municipal and Residual Waste, (717) 787-7381, or may be obtained electronically by the Department's Internet site on the world wide web at: [www.dep.state.pa.us](http://www.dep.state.pa.us) under subject Waste Tire Recycling. Also to be considered for a grant, an applicant must not have contributed, in any manner, to the creation of a noncompliant waste tire pile and must have an identifiable end-use for the remediated waste tires.

Grant funds are intended for activities directly related to the remediation of waste tire piles (such as employe wages, operation of equipment, transportation, processing costs, and the like). Grants may not be used for the purchase of equipment and grant recipients shall use funds only for those activities approved by the Department.

All applicants must complete and submit an official two-part application for each proposed tire pile remediation. The Waste Tire Remediation Grant Part A and B Applications include all the materials and instructions necessary for applying for a grant. Copies of these documents are available by contacting the Division of Municipal and Residual Waste at (717) 787-7381 or may be obtained electronically from the Department's Internet site on the world wide web at: [www.dep.state.pa.us](http://www.dep.state.pa.us) under subject Waste Tire Recycling. Part A and Part B applica-

tions must be completed and submitted by 4 p.m. on September 17, 1999 to: Department of Environmental Protection, Division of Municipal and Residual Waste, 14th Floor—Rachel Carson State Office Building, 400 Market Street, P. O. Box 8472, Harrisburg, PA 17105-8472. Applications which are incomplete or arrive after the deadline will not be considered.

At a minimum, all applications must contain: (1) a description of the applicant's or their contractors experience in waste tire remediation, (2) markets or end-uses for the remediated tires, (3) a schedule for the remediation of tires at the site, (4) proposed cost of the waste tire pile remediation, and (5) any additional information the Department deems necessary. Please follow the instructions in the Part A and B Grant Applications to assure you are submitting all of the necessary information in the correct format.

Persons who have questions about this grant program should contact the Division of Municipal and Residual Waste at (717) 787-7381.

**Recycling Grant Awards Under the Municipal Waste Planning, Recycling and Waste Reduction Act**

The Department of Environmental Protection announces the following grants to municipalities for recycling programs under section 902 of the Municipal Waste Planning, Recycling and Waste Reduction Act (Act 101), (53 P. S. § 4000.902).

Grant funds are used to develop and implement recycling programs. Municipalities and counties are eligible for up to 90% funding of approved recycling program costs. Municipalities considered financially distressed under the Municipalities Financial Recovery Act (53 P. S. §§ 11701.101—11701.501) are eligible to receive funding for an additional 10% of approved costs. All grant awards are predicated on the receipt of recycling fees required by Sections 701 and 702 of Act 101, and the availability of moneys in the Recycling Fund.

Inquiries regarding the grant offerings should be directed to Todd Pejack, Recycling Grants Coordinator, Department of Environmental Protection, Bureau of Land Recycling and Waste Management, Division of Waste Minimization and Planning, Rachel Carson State Office Building, P. O. Box 8472, Harrisburg, PA 17105-8472.

**Act 101**

**Section 902 Recycling Development and Implementation Grants**

**Bureau of Land Recycling and Waste Management**

<i>Municipal Applicant</i>	<i>Project Type</i>	<i>Grant Award</i>
1 Bucks County	Institutional Recycling	\$ 14,026
2 Lower Makefield Township Bucks County	Yardwaste Collection	\$ 32,760
3 Chester County	Home Composting Program	\$ 52,775
4 City of Coatesville Chester County	Recycling Education	\$ 1,890
5 Wallace Township Chester County	Wood Waste Recycling	\$ 21,097
6 West Whiteland Township Chester County	Recycling Education	\$ 1,200
7 Collingdale Borough Delaware County	Curbside Recycling	\$ 21,816

## NOTICES

3403

<i>Municipal Applicant</i>	<i>Project Type</i>	<i>Grant Award</i>
8 Lansdowne Borough Delaware County	Curbside Recycling	\$ 21,308
9 Upper Darby Township Delaware County	Recycling Education	\$ 23,209
10 Cheltenham Township Montgomery County	Curbside & Drop-off Recycling	\$ 303,213
11 Douglass Township Montgomery County	Processing Equipment	\$ 6,871
12 Hatboro Borough Montgomery County	Yardwaste Composting	\$ 16,281
13 Lower Merion Township Montgomery County	Yardwaste Composting	\$ 416,313
14 Montgomery Township Montgomery County	Drop-off Recycling	\$ 6,219
15 Pennsburg Borough Montgomery County	Wood Waste Recycling	\$ 27,382
16 Upper Merion Township Montgomery County	Yardwaste Composting	\$ 273,800
17 Lehighton Borough Carbon County	Curbside Recycling	\$ 19,248
18 Summit Hill Borough Carbon County	Curbside Recycling	\$ 13,526
19 Covington Township Lackawanna County	Drop-off Recycling	\$ 208,057
20 Lackawanna County	Recycling Center Improvements	\$1,551,476
21 Taylor Borough Lackawanna County	Curbside Recycling	\$ 6,075
22 Lehigh County	Office Recycling & Recycling Education	\$ 59,907
23 Lower Macungie Township Lehigh County	Yardwaste Composting	\$ 71,010
24 Lynn Township Lehigh County	Curbside & Drop-Off Recycling	\$ 4,122
25 Exeter Borough Luzerne County	Recycling Center Improvements	\$ 154,953
26 Forty Fort Borough Luzerne County	Yardwaste Collection	\$ 9,765
27 Jenkins Township Luzerne County	Curbside Recycling	\$ 78,750
28 Kingston Borough Luzerne County	Curbside Recycling	\$ 89,100
29 Luzerne County	Recycling Education	\$ 28,800
30 White Haven Borough Luzerne County	Curbside Recycling	\$ 2,976
31 City of Wilkes-Barre Luzerne County	Yardwaste Composting	\$ 44,217
32 Bangor Borough Northampton County	Curbside Recycling	\$ 4,933
33 City of Bethlehem Northampton County	Curbside & Drop-off Recycling	\$ 320,606
34 Lower Mt. Bethel Township Northampton County	Curbside Recycling	\$ 2,383
35 Pike County	Drop-off Recycling	\$ 194,304
36 Frackville Borough Schuylkill County	Curbside & Drop-off Recycling	\$ 51,821
37 Schuylkill Haven Borough Schuylkill County	Yardwaste Collection	\$ 12,319

<i>Municipal Applicant</i>	<i>Project Type</i>	<i>Grant Award</i>
38 Susquehanna County	Recycling Center	\$ 365,215
39 Wayne County	Recycling Center Improvements	\$ 36,221
40 Straban Township Adams County	Wood Waste Processing	\$ 18,877
41 Bedford County	Curbside Recycling	\$ 4,275
42 City of Reading Berks County	Yard Waste Composting	\$ 54,808
43 Robesonia Borough Berks County	Yardwaste Collection	\$ 11,601
44 Sinking Spring Borough Berks County	Yardwaste Collection	\$ 18,450
45 Spring Township Berks County	Yardwaste Collection	\$ 27,603
46 City of Altoona Blair County	Yardwaste Collection	\$ 33,075
47 Blair County	Curbside & Drop-off Recycling	\$ 235,380
48 Camp Hill Borough Cumberland County	Yardwaste Collection	\$ 99,057
49 Cumberland County	Yardwaste Composting	\$ 148,162
50 Lower Allen Township Cumberland County	Curbside Recycling and Yardwaste Composting	\$ 47,385
51 Steelton Borough Dauphin County	Wood Waste Processing	\$ 13,792
52 Huntingdon County	Recycling Education	\$ 14,211
53 Fayette Township Juniata County	Drop-off Recycling	\$ 25,645
54 Elizabethtown Borough Lancaster County	Wood Waste Processing	\$ 14,895
55 Ephrata Borough Lancaster County	Wood Waste Processing	\$ 18,000
56 Ephrata Township Lancaster County	Yardwaste Collection	\$ 15,390
57 Manheim Borough Lancaster County	Recycling Education	\$ 594
58 Annville Township Lebanon County	Yardwaste Collection	\$ 26,775
59 Lebanon County	Curbside Recycling & Yardwaste Composting	\$ 174,735
60 North Lebanon Township Lebanon County	Curbside Recycling & Yardwaste Composting	\$ 67,114
61 Spring Grove Borough York County	Yardwaste Collection	\$ 94,875
62 York County	Curbside Recycling	\$ 44,856
63 Bradford County	Processing Equipment	\$ 142,326
64 Potter Township Centre County	Wood Waste Processing	\$ 17,460
65 State College Borough Centre County	Yardwaste Composting	\$ 290,114
66 Clinton County	Drop-off Recycling	\$ 137,014
67 Lock Haven Borough Clinton County	Curbside & Drop-off Recycling	\$ 40,103
68 Town of Bloomsburg Columbia County	Curbside Recycling	\$ 59,857
69 Columbia County	Office Recycling	\$ 2,555
70 Lycoming County	Commercial Recycling	\$ 130,500

<i>Municipal Applicant</i>	<i>Project Type</i>	<i>Grant Award</i>
71 Northumberland County	Office Recycling & Recycling Education	\$ 29,340
72 New Berlin Borough Union County	Wood Waste Processing	\$ 20,250
73 Union County	Newsprint-to Animal Bedding	\$ 7,200
74 Allegheny County	Drop-off Recycling & Recycling Education	\$ 488,700
75 Coraopolis Borough Allegheny County	Curbside Recycling & Yardwaste Collection	\$ 70,326
76 Municipality of Monroeville Allegheny County	Curbside Recycling & Yardwaste Composting	\$ 52,845
77 Plum Borough Allegheny County	Curbside Recycling	\$ 5,700
78 Robinson Township Allegheny County	Yardwaste Collection	\$ 257,789
79 Scott Township Allegheny County	Curbside Recycling	\$ 133,560
80 Beaver Borough Beaver County	Yardwaste Collection	\$ 65,664
81 Cambria County	Drop-off Recycling	\$ 148,491
82 City of Johnstown Cambria County	Yardwaste Collection	\$ 22,500
83 Fayette County	Public Area Recycling	\$ 5,040
84 Point Marion Borough Fayette County	Curbside Recycling	\$ 3,834
85 Redstone Township Fayette County	Curbside Recycling	\$ 14,868
86 South Union Township Fayette County	Recycling Education	\$ 36,000
87 City of Uniontown Fayette County	Yardwaste Composting	\$ 57,832
88 New Baltimore Borough Somerset County	Drop-off Recycling	\$ 4,770
89 Quemahoning Township Somerset County	Wood Waste Processing	\$ 19,030
90 Somerset Borough Somerset County	Wood Waste Processing	\$ 14,400
91 Canton Township Washington County	Curbside Recycling	\$ 36,657
92 North Strabane Township Washington County	Curbside Recycling & Yardwaste Collection	\$ 20,875
93 City of Washington Washington County	Yardwaste Collection	\$ 39,213
94 City of New Kensington Westmoreland County	Yardwaste Collection	\$ 67,563
95 Westmoreland County	Home Composting & Recycling Education	\$ 117,918
96 City of Titusville Crawford County	Yardwaste Collection	\$ 21,780
97 West Mead Township Crawford County	Processing Equipment	\$ 353,624
98 Edinboro Borough Erie County	Yardwaste Collection	\$ 24,167
99 City of Erie Erie County	Recycling Education	\$ 122,500
100 Harborcreek Township Erie County	Yardwaste Collection	\$ 38,666



<i>Municipal Applicant</i>	<i>Project Type</i>	<i>Grant Award</i>
101 Millcreek Township Erie County	School Recycling	\$ 62,160
102 North East Township Erie County	Wood Waste Processing	\$ 18,074
103 Platea Borough Erie County	Yardwaste Collection	\$ 7,354
104 Summit Township Erie County	Recycling Education	\$ 9,471
105 Brockway Borough Jefferson County	Curbside Recycling	\$ 6,302
106 Lawrence County	Recycling Education	\$ 164,051
107 City of New Castle Lawrence County	Curbside Recycling	\$ 85,500
108 Greenville Borough Mercer County	Yardwaste Composting	\$ 58,897
TOTAL		\$9,312,339

[Pa.B. Doc. No. 99-1053. Filed for public inspection July 2, 1999, 9:00 a.m.]

### Availability of Final General Plan Approval and General Operating Permit for Nonheatset Web Offset Lithographic Printing Presses (BAQ-GPA/GP-10)

The Department of Environmental Protection (Department) finalized the General Plan Approval and General Operating Permit No. BAQ-GPA/GP-10 for nonheatset web offset lithographic printing presses. Notice regarding the availability of the draft general permit was published at 29 Pa.B. 1662 (April 24, 1999).

The Nonheatset Web Press General Permit and associated documents were drafted in consultation with the Graphic Arts Association and the Graphic Arts Technical Foundation. A 45-day comment period was provided and no comments were received, therefore the general permit has been finalized as originally published.

The general permit is now available for use by qualifying applicants. Copies are now available of the final general permit BAQ-GPA/GP-10 and an application form. These documents may be obtained by contacting Kimberly Maneval, Bureau of Air Quality, Rachel Carson State Office Building, P. O. Box 8468, Harrisburg, PA 17105-8468, (717) 787-4325.

The documents have also been placed on the Department's World Wide Web site on the Internet which can be accessed at <http://www.dep.state.pa.us>, select Bureau of Air Quality, then Division of Permits.

JAMES M. SEIF,  
*Secretary*

1. *Statutory Authority and General Description*—In accordance with section 6.1(f) of the Air Pollution Control Act (35 P. S. § 4006.1) and 25 Pa. Code § 127.622, the Department of Environmental Protection (Department) hereby issues this general plan approval and general operating permit for nonheatset web offset lithographic printing press(es) (hereinafter referred to as "Nonheatset Web Press General Permit").

2. *Applicability/Source Coverage Limitations*—This Nonheatset Web Press General Permit is designed to serve as either a general plan approval or as a general operating permit for printers who exclusively use

nonheatset web offset lithographic printing presses or have one or more nonheatset web offset lithographic presses located in a facility. The specific use of the general permit will depend upon permit status, emission levels and location of the facility as outlined below.

Approval herein granted to operate under this Nonheatset Web Press General Permit is limited to a facility engaged in printing on nonheatset web offset lithographic printing press(es) as defined in Condition 16 of this permit. This Nonheatset Web Press General Permit has been established in accordance with the provisions described in 25 Pa. Code Subchapter H of Chapter 127. If additional types of printing or manufacturing is conducted at the facility that can not be regulated by the requirements of this general permit, an operating permit issued in accordance with 25 Pa. Code Subchapter F of Chapter 127 will be required, or, if the facility is a Title V facility, a Title V operating permit issued in accordance with Subchapters F and G will be required.

#### *Operating Permit*

This Nonheatset Web Press General Permit is not intended for use by a Title V facility as defined in 25 Pa. Code § 121.1. A "Title V facility" includes sources that have actual emissions or a potential to emit (PTE) equal to or greater than the maximum permitted emission levels shown in the following table for a single facility: A facility is eligible to operate under this Nonheatset Web Press General Permit if its actual emissions will remain below the maximum permitted emission levels listed below. A nonheatset web offset lithographic printing press facility is exempted from the permit requirements of § 127.402 if it is demonstrated that the facility's actual emissions are less than the permit exemption levels in this section.

<i>Pollutant</i>	<i>Maximum Permitted Emission Levels/Facility</i>	<i>Facility Permit Exemption Levels</i>
CO	<100 TPY	<20 TPY
NOx	<100 TPY*	<10 TPY
SOx	<100 TPY	<8 TPY
VOCs	<50 TPY*	<8 TPY
PM <sub>10</sub>	<100 TPY	<3 TPY

<i>Pollutant</i>	<i>Maximum Permitted Emission Levels/Facility</i>	<i>Facility Permit Exemption Levels</i>
HAP **	<10 TPY	<1 TPY
HAPs	<25 TPY	<2.5 TPY

\*<25 TPY for Severe nonattainment area including Bucks, Chester, Delaware, Montgomery and Philadelphia counties.

\*\*See Table A for a list of hazardous air pollutants.

This Nonheatset Web Press General Permit can be used for any facility engaged in nonheatset web offset printing with actual emissions less than those identified above as the maximum permitted emission levels.

#### *Plan Approval*

This Nonheatset Web Press General Permit shall also serve as a general plan approval for nonheatset web offset lithographic printing press that meet the requirements specified in Conditions 17, 18, 19 and 20 of the general permit. The installation or modification of each nonheatset web offset lithographic printing press that meets the following criteria is exempt from plan approval requirements if the press:

- emits volatile organic compounds (VOCs) at a rate less than 2.7 tons per year (tpy), and;
- emits a single hazardous air pollutant (HAP) at a rate less than 1 tpy, and;
- emits a combination of hazardous air pollutants (HAPs) rates less than 2.5 tons of all HAPs combined per year, or;
- has a cylinder width 17 inches or less.

Facilities claiming an exemption based on the emissions-based criteria (a) through (c) must provide a 15-day prior written notification to the Department indicating that VOC/HAP emission increases will not exceed the emissions-based criteria.

The modification of a nonheatset web offset lithographic printing press includes the addition of a printing unit, coating unit, or other changes that would increase the facility's emission of VOCs or HAPs above the exemption levels specified in criteria (a) through (c).

3. *Application for Use*—Any person proposing to operate, install, or modify a nonheatset web offset lithographic press under this Nonheatset Web Press General Permit shall notify the Department using the Nonheatset Web Offset Lithographic Printing Press General Permit Application provided by the Department. In accordance with 25 Pa. Code § 127.621 (relating to application for use of general plan approvals and general operating permits), the applicant shall receive prior written approval from the Department prior to operating under the general permit.

4. *Compliance*—Any applicant authorized to operate a nonheatset web offset lithographic printing press(es) under this Nonheatset Web Press General Permit shall comply with the terms and conditions of the general permit. The nonheatset web offset lithographic printing press(es) shall be:

- Operated in such a manner as not to cause air pollution.
- Operated and maintained in a manner consistent with good operating and maintenance practices.
- Operated and maintained in accordance with the manufacturer's specifications and the applicable terms and conditions of this Nonheatset Web Press General Permit.

5. *Permit Modification, Suspension and Revocation*—This Nonheatset Web Press General Permit may be modified, suspended or revoked if the Department determines that affected nonheatset web offset lithographic printing press(es) cannot be regulated under this general permit. Authorization to use this Nonheatset Web Press General Permit shall be suspended or revoked if the permittee fails to comply with applicable terms and conditions of the Nonheatset Web Press General Permit.

The approval herein granted to operate the nonheatset web offset lithographic printing press(es) shall be suspended, if, at any time, the permittee causes, permits or allows any modification without Departmental approval (as defined in 25 Pa. Code § 121.1) of the nonheatset web offset lithographic printing press(es) covered by this general permit. Upon suspension of the general permit, the permittee may not continue to operate or use said nonheatset web offset lithographic printing press(es). If warranted, the Department will require that the nonheatset web offset lithographic printing press(es) be permitted under the state operating permit and/or Title V operating permit program requirements in 25 Pa. Code Chapter 127, as appropriate.

6. *Notice Requirements*—The applications and notifications required by 25 Pa. Code § 127.621 shall be submitted to the appropriate Regional Office responsible for issuing general permits in the county in which the nonheatset web offset lithographic printing press is, or will be, located. As required under § 127.621(b), the application shall be either hand delivered or transmitted by certified mail return receipt requested.

The permittee shall notify the Department, in writing, within 24 hours of the discovery of any malfunction during a business day or by 5 p.m. on the first business day after a weekend or holiday of any malfunction of the nonheatset web offset lithographic printing press(es) which results in, or may result in, the emission of air contaminants in excess of the limitations specified in, or established under, any applicable rule or regulation contained in 25 Pa. Code, Subpart C, Article III (relating to air resources).

7. *Sampling and Testing*—The permittee shall, upon the request of the Department, provide input material analyses, or input material samples used in any nonheatset web offset lithographic printing press(es) authorized to operate under this general permit.

8. *Monitoring, Recordkeeping and Reporting*—The permittee shall comply with applicable monitoring, recordkeeping and reporting requirements set forth in 25 Pa. Code Chapter 139 (relating to sampling and testing), the Air Pollution Control Act, the Clean Air Act and the applicable regulations under the acts.

9. *Term of Permit*—The Nonheatset Web Press General Permit is issued for a fixed term of 5 years. The Department will notify each applicant, by letter, when approval to operate under this general permit is granted.

10. *Permit and Administrative Fees*—The Nonheatset Web Press General Permit establishes the following application and renewal fees payable every 5 years if no equipment changes occur:

- Two hundred fifty dollars during the 1999 calendar year.
- Three hundred dollars during the 2000-2004 calendar years.
- Three hundred seventy-five dollars beginning in the 2005 calendar year.

An additional plan approval application fee as indicated above is required each time the permittee installs or modifies a nonheatset web offset lithographic printing press. The installation or modification of a nonheatset web offset lithographic printing press must be conducted according to the terms and conditions of this general permit. Two or more nonheatset web offset lithographic printing presses may be installed under a single plan approval fee.

11. *Expiration and Renewal of Permit*—The permittee's right to operate under this Nonheatset Web Press General Permit terminates on the date of expiration of this permit unless a timely and complete application for the renewal of the general permit is submitted to the Department at least 30 days prior to the permit expiration date.

Upon receipt of a complete and timely application for renewal, the nonheatset web offset lithographic printing press(es) may continue to operate subject to final action by the Department on the renewal application. This protection shall cease to exist if, subsequent to a completeness determination, the applicant fails to submit by the deadline specified in writing by the Department any additional information required by the Department to process the renewal application.

The Nonheatset Web Press General Permit application for renewal shall include the identity of the owner or operator, location of the nonheatset web offset lithographic printing press(es), current permit number, description of source category, the appropriate renewal fee listed in Condition 10 of this permit and any other information requested by the Department. At a minimum, the permit renewal fee shall be submitted to the Department at least 30 days prior to the expiration of the Nonheatset Web Press General Permit.

12. *Applicable Laws*—Nothing in this Nonheatset Web Press General Permit relieves the permittee from its obligation to comply with all applicable Federal, state and local laws and regulations.

13. *Prohibited Use*—Any air contamination source that is subject to the requirements of 25 Pa. Code Chapter 127, Subchapter D (relating to prevention of significant deterioration), 25 Pa. Code Chapter 127, Subchapter E (relating to new source review) 25 Pa. Code Chapter 127, Subchapter G (relating to Title V operating permits), or 25 Pa. Code § 129.91 (relating to control of major sources of NO<sub>x</sub> and VOCs), may not operate under this Nonheatset Web Press General Permit. Title V facilities may use this Nonheatset Web Press General Permit as a general plan approval when the major new source review and prevention of significant deterioration requirements are not applicable.

14. *Transfer of Ownership or Operation*—The permittee may not transfer the Nonheatset Web Press General Permit except as provided in 25 Pa. Code § 127.464 (relating to transfer of operating permits).

15. *Plan Approval*—This Nonheatset Web Press General Permit authorizes the construction and operation of nonheatset web offset lithographic printing press(es) that meet the best available technology (BAT) required under 25 Pa. Code §§ 127.1 and 127.12(a)(5). For purposes of this general permit, the emission limits specified in Conditions 17, 18, 19 and 20 of this general permit are BAT for nonheatset web offset lithographic printing press(es).

16. *Definitions*—For purposes of this Nonheatset Web Press General Permit, the following definitions apply:

a. *Alcohol*—A class of compounds containing a single hydroxyl group OH. When used as a fountain solution additive for offset lithographic printing, the term includes: ethanol, n-propanol and isopropanol.

b. *Alcohol Substitutes*—Nonalcohol additives that contain VOCs and are used in the fountain solution. The term includes additives used to reduce the surface tension of water or prevent piling (ink build-up).

c. *Automatic Blanket Wash System*—Equipment used to remotely clean lithographic blankets which may include, but is not limited to those utilizing a cloth and expandable bladder, brush, spray or impregnated cloth system.

d. *Batch*—A supply of fountain solution that is prepared and used without alteration until completely used or removed from the printing process. For the purposes of this general permit, this term includes solutions that are either prepared in discrete batches or solutions that are continuously blended with automix units.

e. *Cleaning Solution*—Liquid solvents or solutions used to remove ink and debris from the operating surfaces of the printing press and its parts.

f. *Dampening System*—Equipment used to deliver the fountain solution to the lithographic plate.

g. *Fountain Solution*—A mixture of water, nonvolatile printing chemicals and an additive (liquid) that reduces the surface tension of the water so that it spreads easily across the printing plate surface. The fountain solution wets the nonimage area so that the ink is maintained within the image areas. Nonvolatile additives include mineral salts and hydrophilic gums. For the purpose of this general permit, the additives may include a VOC content of 5.0% or less. Alcohol and alcohol substitutes, including isopropyl alcohol, glycol ethers and ethylene glycol, are the most common VOC additives used to reduce the surface tension of the fountain solution.

h. *Fountain Solution Recirculating Reservoir*—The collection tank which accepts fountain solution recirculated from printing unit(s). The tanks typically contains a coarse filter to remove contaminants from the fountain solution and in some cases, are equipped with cooling coils for refrigeration of the fountain solution.

i. *Inking System*—A series of rollers used to meter the ink onto the lithographic plate. The system can include agitators, pumps, and totes and other types of ink containers.

j. *Lithography*—A planographic printing process where the image and nonimage areas are chemically differentiated; the image area is oil receptive and the nonimage area is water receptive. This method differs from other printing methods, where the image is typically printed from a raised or recessed surface.

k. *Nonheatset*—A lithographic printing process where the printing inks are set without the use of heat. Traditional nonheatset inks set and dry by absorption and/or oxidation of the ink oils. For the purposes of this general permit, ultraviolet-cured and electron beam-cured inks are considered nonheatset, although radiant energy is required to cure these inks.

l. *Offset*—A printing process that transfers the ink film from the lithographic plate to an intermediary surface (blanket), which, in turn, transfers the ink film to the substrate.

m. *Press*—For purposes of this general permit, a printing production assembly composed of one or more units

used to produce a printed substrate or a web. The term includes any associated coating, spray powder application or infra-red heating units.

n. *Unit*—The smallest complete printing component, composed of inking and dampening systems, of a printing press.

o. *VOC Composite Partial Vapor Pressure*—The sum of the partial pressure of the compounds defined as VOCs. VOC composite partial pressure is calculated as follows:

$$PP_c = \sum_{i=1}^n \frac{(W_i)(VP_i)/MW_i}{\frac{W_w}{MW_w} + \frac{W_c}{MW_c} + \sum_{i=1}^n \frac{W_i}{MW_i}}$$

Where:

$W_i$  = Weight of the "i"th VOC compound, in grams  
 $W_w$  = Weight of water, in grams  
 $W_c$  = Weight of exempt compound, in grams  
 $MW_i$  = Molecular weight of the "i"th VOC compound, in g/g-mole  
 $MW_w$  = Molecular weight of water, in g/g-mole  
 $MW_c$  = Molecular weight of exempt compound, in g/g-mole  
 $PP_c$  = VOC composite partial pressure at 20°C, in mm Hg  
 $VP_i$  = Vapor pressure of the "i"th VOC compound at 20°C, in mm Hg

p. *Web*—A continuous roll of paper used as the printing substrate in a printing process.

17. *Equipment Standards for Fountain Solutions*—Any nonheatset web offset lithographic printing press(es) subject to this Nonheatset Web Press General Permit shall meet one of the following requirements for the fountain solution used on that press:

a. Maintain the as applied VOC content of the fountain solution at or below 5.0% by weight, and;

b. The fountain solution shall contain no alcohol.

18. *Equipment Standards for Blanket and Roller Cleaning Solutions*—Any blanket and roller cleaning solution used on a nonheatset web offset lithographic printing press subject to the terms and conditions this Nonheatset Web Press General Permit shall meet one of the following requirements:

a. VOC content, as applied, is less than or equal to 30 percent by weight, or;

b. VOC composite partial vapor pressure, as used, is less than or equal to 10 mm Hg at 20°C (68°F).

c. The use of cleaning solutions not meeting Conditions 18 a. or b. is permitted provided that the quantity used does not exceed 55 gallons over any twelve consecutive months.

19. *Equipment Standards for Solvent Containers*—Any owner/operator of a nonheatset web offset lithographic printing press(es) subject to this Nonheatset Web Press General Permit shall keep all solvent containers closed at all times unless filling, draining or performing cleanup operations.

20. *Equipment Standards for Solvent Laden Shop Towels*—Any owner/operator of a nonheatset web offset lithographic printing press(es) subject to this Nonheatset Web Press General Permit shall keep all solvent laden shop towels in a closed container when not being used.

21. *Testing of Fountain Solutions*—Any owner/operator of a nonheatset web offset lithographic printing press(es) subject to this Nonheatset Web Press General Permit shall determine the VOC content of fountain solution by one of the following procedures:

a. Analysis by USEPA Method 24 of a fountain solution sample,

b. Calculation which combines USEPA Method 24 analytical VOC content data for the concentrated materials used to prepare the press ready fountain solution and records of the proportions in which they are mixed. The calculation shall only be performed once for each press ready fountain solution and kept in the form of a batch log. See the Fountain Solution Batch VOC Content Form and Fountain Solution VOC Addition Form attached to this general permit. The analysis of the concentrated fountain solution may be performed by the supplier(s) of those materials.

22. *Testing of Blanket and Roller Cleaning Solutions*—Any owner/operator of a nonheatset web offset lithographic printing press(es) subject to this Nonheatset Web Press General Permit shall determine the VOC content or VOC composite partial vapor pressure of cleaning solutions by one of the following procedures:

a. Analysis by USEPA Method 24 of a cleaning solution sample for VOC content or by an appropriate method for composite partial vapor pressure,

b. Calculation which combines USEPA Method 24 analytical VOC content data for the concentrated materials used to prepare the press ready cleaning solution and records of the proportions in which they are mixed. The calculation shall only be performed once for each press ready cleaning solution and kept in the form of a batch log. See the Cleaning Solution Batch VOC Content Form attached to this general permit. The analysis of the concentrated cleaning solution may be performed by the supplier(s) of those materials,

c. Calculation for VOC composite partial vapor pressure which combines analytical VOC vapor pressure data for the concentrated materials used to prepare the press ready cleaning solution and records of the proportions in which they are mixed. The analysis and vapor pressure determinations of the concentrated material(s) may be performed by the suppliers(s) of the material(s).

23. *Monitoring Requirements for Automatic Blanket Wash Systems*—Any owner/operator of a nonheatset web offset lithographic printing press(es) subject to this Nonheatset Web Press General Permit using an automatic blanket wash system that mixes cleaning solution at the point of application must demonstrate compliance with the VOC limitation in Condition 18 a. or b. shall document that flow meters or fixed volume spray systems result in the VOC content of the mixed solution complies with Condition 18 a. or b. of the general permit.

24. *Recordkeeping Requirements*—Any owner/operator of a nonheatset web offset lithographic printing press(es) subject to this Nonheatset Web Press General Permit shall collect and record the applicable information specified in this Condition. The information shall be maintained at the facility for a minimum of 5 years. The Department or an authorized representative of the Department shall, at reasonable times, have access to and require the production of books, papers or records, as the Department may reasonably prescribe relevant to compliance with the terms and conditions in this general permit. The information required includes the following:

a. For each nonheatset web offset lithographic ink or conventional varnish used: the monthly consumption in pounds or gallons; the percent by weight VOC and HAP content, as applied; and, an estimate of VOC and HAP emissions. Alternately, the ink with the highest VOC and HAP content may be used to represent all inks used by all nonheatset web offset lithographic printing presses.

b. For each fountain solution and additive: the monthly consumption in pounds or gallons; the percent by weight or weight to volume ratio (lbs/gal) VOC and HAP content and an estimate of VOC and HAP emissions.

c. For each blanket and roller cleaning solution used: the monthly consumption in pounds or gallons; the percent by weight or weight to volume ratio (lbs/gal) VOC and HAP content and an estimate of VOC and HAP emissions.

d. For each month of operation, the volume of all cleaning solution used which does not meet Condition 18 a. or b.

e. For each month of operation, an estimate of VOC and HAP emissions during the latest 12 months.

**Fountain Solution Batch VOC Content Form**

*Fountain Solution Concentrate*

Name: \_\_\_\_\_

Formula Number: \_\_\_\_\_

Density(lbs/gal)\*: \_\_\_\_\_

VOC Content (lbs/gal)\*\*: \_\_\_\_\_

*Fountain Solution Additive*

Name: \_\_\_\_\_

Formula Number: \_\_\_\_\_

Density(lbs/gal)\*: \_\_\_\_\_

VOC Content (lbs/gal)\*\*: \_\_\_\_\_

\* Density may be obtained from data on the Material Safety Data Sheet or determined by multiplying the specific gravity from the MSDS by 8.33 pounds per gallon.

\*\* VOC content may be determined by either using the Material Safety Data Sheet, conducting USEPA Method 24, or by summing the percent composition of each individual VOC and multiplying it by the density. Do not include exempt VOCs, especially Methylene Chloride and 1,1,1-Trichloroethane.

\_\_\_\_\_ Ounces of Fountain Concentrate Added Per Gallon of Water.

\_\_\_\_\_ Ounces of Fountain Additive Added Per Gallon of Water.

Press Ready VOC Concentration:

1. Weight of VOC in Concentrate =  $\frac{\text{Oz. Concentrate} \times \text{VOC Content (lbs/gal)}}{128 \text{ oz/gal}}$

2. Weight of VOC in Additive =  $\frac{\text{Oz. Additive} \times \text{VOC Content (lbs/gal)}}{128 \text{ oz/gal}}$

3. Weight Percent VOC =  $\frac{\text{Result of Steps 1+2}}{\text{Result of 1+2} + 8.33}$

**Fountain Solution VOC Addition Form**

Indicate When Any VOC Is Added To Press Ready Fountain Solution

<i>Date</i>	<i>Press or Fountain Recirculator</i>	<i>Material Added</i>	<i>Amount Added In Ounces</i>	<i>Final VOC Content In Weight Percent</i>

Final Press Ready VOC Concentration:

1. Weight of VOC in Concentrate =  $\frac{\text{Oz. Concen.} \times \text{VOC Content (lbs/gal)}}{128 \text{ oz/gal}}$

2. Weight of VOC in Additive =  $\frac{\text{Oz. Additive} \times \text{VOC Content (lbs/gal)}}{128 \text{ oz/gal}}$

3. Weight of VOC Added =  $\frac{\text{Oz. Added VOC} \times \text{VOC Content (lbs/gal)}}{128 \text{ oz/gal}}$

4. Weight Percent VOC =  $\frac{\text{Result of Steps 1+2+3}}{\text{Result of 1+2+3} + 8.33}$

**Cleaning Solution Batch VOC Content Form**

*Cleaning Solution Concentrate*

Name: \_\_\_\_\_

Formula Number: \_\_\_\_\_

Density(lbs/gal)\*: \_\_\_\_\_

VOC Content (lbs/gal)\*\*: \_\_\_\_\_

*Cleaning Solution Additive*

Name: \_\_\_\_\_

Formula Number: \_\_\_\_\_

Density(lbs/gal)\*: \_\_\_\_\_

VOC Content (lbs/gal)\*\*: \_\_\_\_\_

\* Density may be obtained from the Material Safety Data Sheet or by multiplying the specific gravity from the MSDS by 8.33 pounds per gallon.

\*\* VOC content may either be obtained from the Material Safety Data Sheet, conducting USEPA Method 24, or determined by summing the percent composition of each individual VOC and multiplying it by the density. Do not include exempt VOCs, especially Methylene Chloride and 1,1,1-Trichloroethane.

\_\_\_\_\_ Ounces of Cleaning Solution Concentrate Added Per Gallon of Water.

\_\_\_\_\_ Ounces of Cleaning Solution Additive Added Per Gallon of Water.

Press Ready VOC Concentration:

1. Weight of VOC in Concentrate =  $\frac{\text{Oz. Concentrate} \times \text{VOC Content (lbs/gal)}}{128 \text{ oz/gal}}$

2. Weight of VOC in Additive =  $\frac{\text{Oz. Additive} \times \text{VOC Content (lbs/gal)}}{128 \text{ oz/gal}}$

3. Weight Percent VOC =  $\frac{\text{Result of Steps 1+2}}{\text{Result of 1+2} + 8.33}$

**NONHEATSET WEB PRESS GENERAL PERMIT RECORDKEEPING FORMAT**

Month: \_\_\_\_\_

*Inks:*

Vendor	Color	Formula #	VOC Content <sup>1</sup>	HAP	HAP Content <sup>2</sup>	Usage <sup>3</sup>	VOC <sup>7</sup> Emissions	HAP <sup>7</sup> Emissions
ABC Inks	Black	P-45701	15%	N/A	N/A	10,000 lbs.		

*Fountain Solution Concentrate:*

Vendor	Formula #	VOC Content <sup>4</sup>	VOC Content As Applied <sup>1</sup>	HAP	HAP Content <sup>5</sup>	Usage <sup>3</sup>	VOC <sup>7</sup> Emissions	HAP <sup>7</sup> Emissions
Wet All I	WA-001	2.3	4.5%	2-Butoxy-ethanol	2.3	200 gal		

*Fountain Solution Additive:*

Vendor	Formula #	VOC Content <sup>4</sup>	VOC Content As Applied <sup>1</sup>	HAP	HAP Content <sup>5</sup>	Usage <sup>3</sup>	VOC <sup>7</sup> Emissions	HAP <sup>7</sup> Emissions
Wet All II	WA-002	6.0	4.5%	2-Butoxy-ethanol	6.0	200 gal		

*Cleaning Solutions:*

Vendor	Formula #	VOC Content <sup>4</sup>	VOC Content As Applied <sup>1</sup>	Vapor Pressure <sup>6</sup>	HAP	HAP Content <sup>5</sup>	Usage <sup>3</sup>	VOC <sup>7</sup> Emissions	HAP <sup>7</sup> Emissions
Clean All	CA-010	7.5	100%	5 mmHg	Xylene, cumene	2-Butoxy-ethanol	2.0	850 gal	

*Coatings:*

Vendor	Formula #	VOC Content <sup>1,4</sup>	VOC Content As Applied <sup>1,4</sup>	HAP	HAP Content <sup>2,5</sup>	Usage <sup>3</sup>	VOC <sup>7</sup> Emissions	HAP <sup>7</sup> Emissions
Coatings, Inc.	P-46400	42.6%	42.6%	N/A	N/A	2,000 lbs		

- <sup>1</sup>VOC content in weight percent
- <sup>2</sup>HAP content in weight percent
- <sup>3</sup>Usage in pounds or gallons
- <sup>4</sup>VOC Content in pounds/gallon
- <sup>5</sup>HAP Content in pounds/gallon
- <sup>6</sup>Vapor pressure in millimeters of mercury (mm Hg)
- <sup>7</sup>Use appropriate emission/retention factors as identified in permit application

*12-Month Totals*

The U.S. Environmental Protection Agency requires the Department to track emissions on a 12-month total basis rather than on a calendar basis. This means that emission estimates should be recalculated each month totaling emissions that occurred during the last 12 months. For example, at the end of March, 1998 you would total the emissions which occurred from April, 1997 through March, 1998; at the end of April, 1998 you would total the emissions which occurred from May, 1997 through April, 1998, etc.

*Sample Form*

*12-Month Totals for Calendar Year - - - -*

<i>Month</i>	<i>VOCs</i>	<i>HAPs</i>	<i>12-Mon. Tot. VOCs</i>	<i>12-Mon. Tot. HAPs</i>
January				
February				
March				
April				
May				
June				
July				
August				
September				
October				
November				
December				

[Pa.B. Doc. No. 99-1054. Filed for public inspection July 2, 1999, 9:00 a.m.]

**Small Water Systems Technical Assistance Center  
Advisory Board; Special Committee Meeting**

The Capability Enhancement Committee will hold a meeting on Tuesday, July 13, 1999, from 9:30 a.m. to 12 noon in the 11th Floor Conference Room of the Rachel Carson State Office Building, Harrisburg, PA. The purpose of the meeting will be to continue discussion of the two parts of the Department's proposed public water system capacity development strategy: (1) Capability Enhancement Priority Rating System and (2) Public Participation Strategy.

Questions concerning this schedule or agenda items can be directed to Donna Green at (717) 787-0122 or e-mail at [Green.Donna@dep.state.pa.us](mailto:Green.Donna@dep.state.pa.us). This schedule, an agenda for the meeting, and notices of meeting changes will be available through the Public Participation Center on DEP's World Wide Web site at <http://www.dep.state.pa.us>.

Persons in need of accommodations as provided for in the Americans with Disabilities Act of 1990 should contact Donna Green directly at (717) 787-0122 or through the Pennsylvania AT&T Relay Service at (800) 654-5984 (TDD) to discuss how the Department may accommodate their needs.

JAMES M. SEIF,  
*Secretary*

[Pa.B. Doc. No. 99-1055. Filed for public inspection July 2, 1999, 9:00 a.m.]

**State Board for Certification of Sewage Treatment  
Plant and Waterworks Operators; Special Committee Meeting**

The Water Workgroup will hold a special meeting on Tuesday, July 20, 1999 from 9:30 a.m. to 3:30 p.m. at the PA Municipal Authorities Association in Wormleysburg, PA. The purpose of the meeting will be to discuss the results of the Water Training Priority Assessment Survey and to review the final draft training matrix.

Questions concerning this schedule or agenda items can be directed to Christine Sowers at (717) 787-0122 or e-mail at [Sowers.Christine@dep.state.pa.us](mailto:Sowers.Christine@dep.state.pa.us). This schedule, an agenda for the meeting, and notices of meeting changes will be available through the Public Participation Center on DEP's World Wide Web site at <http://www.dep.state.pa.us>.

Persons in need of accommodations as provided for in the Americans with Disabilities Act of 1990 should contact Christine Sowers directly at (717) 787-0122 or through the Pennsylvania AT&T Relay Service at (800) 654-5984 (TDD) to discuss how the Department may accommodate their needs.

JAMES M. SEIF,  
*Secretary*

[Pa.B. Doc. No. 99-1056. Filed for public inspection July 2, 1999, 9:00 a.m.]

### Wetlands Protection Advisory Committee; Cancellation of Meeting

The Wetlands Protection Advisory Committee meeting scheduled for July 6, 1999, has been canceled. The next meeting is scheduled for September 7, 1999, in the first floor conference room of the Rachel Carson State Office Building.

JAMES M. SEIF,  
*Secretary*

[Pa.B. Doc. No. 99-1057. Filed for public inspection July 2, 1999, 9:00 a.m.]

## DEPARTMENT OF HEALTH

### Human Immunodeficiency Virus (HIV) Community Prevention Planning Committee; Public Meetings

The Statewide HIV Community Prevention Planning Committee, established by the Department of Health under sections 301 and 317 of the Public Health Service Act (42 U.S.C.A. §§ 241(a) and 247(b)), will hold a public meeting on Wednesday, July 21, 1999, and Thursday, July 22, 1999.

The meeting will be held at the Sheraton Inn Harrisburg East, 800 East Park Avenue, Harrisburg, PA, from 10 a.m. to 4 p.m.

For additional information please contact Thomas M. DeMelfi, Department of Health, Division of HIV/AIDS, PO Box 90, Room 912, Health and Welfare Building, Harrisburg, PA 17108, (717) 783-0574.

Persons with a disability who desire to attend the meeting, and require an auxiliary aid service or other accommodation to do so, should also contact Thomas DeMelfi at (717) 783-0574, V/TT (717) 783-6514 for speech and/or hearing impaired persons or the Pennsylvania AT&T Relay Services at 1 (800) 654-5984 [TT].

ROBERT S. ZIMMERMAN, Jr.,  
*Secretary*

[Pa.B. Doc. No. 99-1058. Filed for public inspection July 2, 1999, 9:00 a.m.]

### Laboratories Approved to Determine Blood Alcohol Content Under the Clinical Laboratory Act, the Vehicle Code, the Fish and Boat Code and the Game and Wildlife Code

The following laboratories are licensed by the Department of Health (Department) under the Clinical Laboratory Act (35 P.S. §§ 2151—2165) and are currently approved by the Department under 28 Pa. Code §§ 5.50 and 5.103 (relating to approval to provide special analytical services; and blood tests for blood alcohol content) to perform alcohol analyses of blood and/or serum and plasma. This approval is based on demonstrated proficiency in periodic tests conducted by the Department's Bureau of Laboratories. Since procedures for determining the alcohol content of serum and plasma are identical and results obtained from serum or plasma derived from a blood sample are the same, laboratories that demonstrate reliability in the analysis of serum proficiency testing specimens are approved to analyze both serum and

plasma. These laboratories are also approved and designated under the provisions of the Vehicle Code, 75 Pa.C.S. §§ 1547 and 3755 (relating to chemical testing to determine amount of alcohol or controlled substance; and reports by emergency room personnel), the Fish and Boat Code, 30 Pa.C.S. § 5125 (relating to chemical testing to determine amount of alcohol or controlled substance) and the Game and Wildlife Code, 34 Pa.C.S. § 2502 (relating to hunting or furtaking under the influence of alcohol or controlled substance) as qualified to perform the types of specialized services which will reflect the presence of alcohol in blood and/or serum and plasma. Laboratories located outside this Commonwealth may not provide blood and/or serum and plasma alcohol testing services in Pennsylvania unless they are specifically licensed by the Department under the Clinical Laboratory Act.

Persons seeking forensic blood and/or serum and plasma analysis services from the following designated laboratories should determine that the laboratory employs techniques and procedures acceptable for forensic purposes, and that the director of the facility is agreeable to performing determinations for this purpose. The list of approved laboratories will be revised approximately semi-annually and published in the *Pennsylvania Bulletin*.

The Department's blood alcohol and serum/plasma alcohol proficiency testing programs are approved by the United States Department of Health and Human Services (HHS) in accordance with the requirements contained in the Clinical Laboratory Improvement Amendments of 1988 (42 CFR 493.901 and 493.937) which are administered by the Health Care Financing Administration (HCFA). Participation in these programs may therefore be used to demonstrate acceptable performance for approval purposes under both Federal and Commonwealth statutes.

Questions regarding this list should be directed to Dr. M. Jeffery Shoemaker, Division of Chemistry and Toxicology, Department of Health, Bureau of Laboratories, P. O. Box 500, Exton, PA 19341-0500, (610) 363-8500.

Persons with a disability who require an auxiliary aid service should contact Dr. Shoemaker at V/TT: (717) 783-6514 for speech and/or hearing impaired persons or the Pennsylvania AT & T Relay Service at (800) 654-5984 [TT].

The symbols S and B indicate the following:

S = approved for serum and plasma analyses  
B = approved for blood analyses  
SB = approved for serum, plasma and blood analyses

Abington Memorial Hospital-S  
1200 Old York Road  
Abington, PA 19001  
215-576-2350

Albert Einstein Medical Center-Northern Division-S  
5501 Old York Road  
Philadelphia, PA 19141  
215-456-6100

Allegheny County Coroner's Office-SB  
Division of Laboratories  
10 County Office Building  
Pittsburgh, PA 15219  
412-355-6873

Allegheny General Hospital-Dept. Lab. Medicine-S  
320 East North Avenue  
Pittsburgh, PA 15212  
412-359-3521



Allegheny Valley Hospital Laboratory-SB  
1300 Carlisle Street  
Natrona Heights, PA 15065  
412-224-5100

Altoona Hospital-SB  
620 Howard Avenue  
Altoona, PA 16601  
814-946-2340

American Medical Laboratories, Inc.-SB  
14225 Newbrook Drive  
Chantilly, VA 20153  
703-802-6900

Analytic Bio-Chemistries, Inc.-SB  
1680-D Loretta Avenue  
Feasterville, PA 19053  
215-322-9210

Armstrong County Memorial Hospital-S  
R. D.# 8, Box 50  
Kittanning, PA 16201  
412-543-8122

Associated Clinical Laboratories-SB  
1526 Peach Street  
Erie, PA 16501  
814-453-6621

Associated Regional and University Pathologists-SB  
500 Chipeta Way  
Salt Lake City, UT 84108  
800-242-2787

Ayer Clinical Laboratory-Penn Hospital-S  
8th & Spruce Streets  
Philadelphia, PA 19107  
215-829-3541

Bon Secours-Holy Family Regional Health-SB  
2500 Seventh Avenue  
Altoona, PA 16602  
814-949-4495

Braddock Medical Center-S  
412 Holland Avenue  
Braddock, PA 15104  
412-636-5000

Bradford Hospital Laboratory-SB  
116-156 Interstate Parkway  
Bradford, PA 16701  
814-834-8282

Brandywine Hospital and Trauma Center-S  
Route 30 Bypass  
Coatesville, PA 19320  
610-383-8000

Brownsville General Hospital Laboratory-S  
125 Simpson Road  
Brownsville, PA 15417  
724-785-7200

Butler Memorial Hospital-S  
911 East Brady Street  
Butler, PA 16001  
724-284-4510

Canonsburg General Hospital-SB  
R. D.# 1, Box 147, Route 519  
Canonsburg, PA 15317  
724-745-6100

Carlisle Hospital-S  
245 Parker Street  
Carlisle, PA 17013  
717-249-1212

Centre Community Hospital-B  
1800 East Park Avenue  
State College, PA 16803  
814-234-6117

Chambersburg Hospital-S  
112 North Seventh Street  
Chambersburg, PA 17201  
717-267-7152

Charles Cole Memorial Hospital-S  
R. D. # 1, Box 205  
Coudersport, PA 16915  
814-274-9300

Chester County Hospital-S  
701 East Marshall Street  
West Chester, PA 19380  
610-431-5182

Chestnut Hill Hospital-S  
8835 Germantown Avenue  
Philadelphia, PA 19118  
215-248-8630

Childrens Hospital of Philadelphia-S  
One Children's Center, 34th and Civic Center Blvd.  
Philadelphia, PA 19104  
215-590-1000

Citizens General Hospital-SB  
651 Fourth Avenue  
New Kensington, PA 15068  
412-337-5031

City Avenue Hospital-S  
4150 City Avenue  
Philadelphia, PA 19131  
215-871-1000

Clarion Hospital-SB  
One Hospital Drive  
Clarion, PA 16214  
814-226-9500

Clearfield Hospital Laboratory-S  
809 Turnpike Avenue, P. O. Box 992  
Clearfield, PA 16830  
814-765-5341

Clintox Laboratories-S  
601 Gay Street  
Phoenixville, PA 19460  
610-933-6550

Community Hospital-B  
North Fraley Street  
Kane, PA 16735  
814-837-8585

Community Hospital of Lancaster-S  
1100 East Orange Street  
Lancaster, PA 17602  
717-397-3711

Community Medical Center-S  
1822 Mulberry Street  
Scranton, PA 18510  
717-969-8000

Conemaugh Valley Memorial Hospital-SB  
1086 Franklin Street  
Johnstown, PA 15905  
814-534-9000

Corry Memorial Hospital-S  
612 West Smith Street  
Corry, PA 16407  
814-664-4641

Crozer-Chester Medical Center-Springfield-S  
190 West Sproul Road  
Springfield, PA 19064  
610-328-9200

Crozer Chester Medical Center-S  
1 Med Ctr. Blvd.  
Upland, PA 19013  
610-447-2000

Delaware County Memorial Hospital-S  
501 N. Lansdowne Avenue  
Drexel Hill, PA 19026  
610-284-8100

Department of Pathology & Lab Med-HUP-SB  
3400 Spruce Street  
Philadelphia, PA 19104  
215-662-6880

Doylestown Hospital-S  
595 West State Street  
Doylestown, PA 18901  
215-345-2250

DrugScan, Inc.-SB  
1119 Mearns Road, P. O. Box 2969  
Warminster, PA 18974  
215-674-9310

DuBois Regional Medical Center-West Unit-S  
100 Hospital Avenue  
DuBois, PA 15801  
814-371-2200

Easton Hospital-SB  
250 South 21st Street  
Easton, PA 18042  
610-250-4140

Elk County Regional Medical Center-S  
94 Hospital Street  
Ridgway, PA 15853  
814-776-6111

Elkins Park Hospital-S  
60 East Township Line Road  
Elkins Park, PA 19027  
215-663-6753

Ellwood City General Hospital-S  
724 Pershing Street  
Ellwood City, PA 16117  
724-752-0081

Endless Mountains Health Systems-B  
3 Grow Avenue  
Montrose, PA 18801  
717-278-3801

Ephrata Community Hospital-S  
169 Martin Avenue, P. O. Box 1002  
Ephrata, PA 17522  
717-733-0311

Episcopal Hospital-S  
100 East Lehigh Avenue  
Philadelphia, PA 19125  
215-427-7333

Evangelical Community Hospital-SB  
1 Hospital Drive  
Lewisburg, PA 17837  
717-522-2510

Forbes Regional Health Center-SB  
2570 Haymaker Road  
Monroeville, PA 15146  
412-858-2560

Frankford Hospital Bucks County Campus-S  
380 North Oxford Valley Road  
Langhorne, PA 19047  
215-934-5227

Frankford Hospital-Frankford Division-S  
Frankford Avenue and Wakeling Street  
Philadelphia, PA 19124  
215-831-2068

Frankford Hospital-Torresdale Division-S  
Red Lion and Knights Road  
Philadelphia, PA 19114  
215-612-4000

Frick Hospital-S  
508 South Church Street  
Mount Pleasant, PA 15666  
412-547-1500

Fulton County Medical Center-S  
216 South First Street  
McConnellsburg, PA 17233  
717-485-3155

Geisinger Medical Center-SB  
North Academy Road  
Danville, PA 17822  
717-271-6338

George Tolstoi Laboratory-Uniontown Hospital-S  
500 W. Berkeley Street  
Uniontown, PA 15401  
724-430-5143

Germantown Hospital and Medical Center-S  
One Penn Boulevard  
Philadelphia, PA 19144  
215-951-8800

Gettysburg Hospital-SB  
147 Gettys Street  
Gettysburg, PA 17325  
717-334-2121

Gnaden Huetten Memorial Hospital-SB  
Eleventh and Hamilton Streets  
Lehighon, PA 18235  
610-377-1300

Good Samaritan Hospital-SB  
Fourth and Walnut Streets, P. O. Box 1281  
Lebanon, PA 17042  
717-270-7500

Good Samaritan Regional Medical Center-B  
700 East Norwegian Street  
Pottsville, PA 17901  
717-621-4000

Graduate Hospital-S  
1800 Lombard Street  
Philadelphia, PA 19146  
215-893-2240

Grand View Hospital-S  
700 Lawn Avenue  
Sellersville, PA 18960  
215-257-3611

Greene County Memorial Hospital-S  
Bonar Avenue  
Waynesburg, PA 15370  
724-627-3101

Guthrie Clinic Pathology Laboratory-S  
Guthrie Square  
Sayre, PA 18840  
717-888-5858

Hahnemann University Hospital-S  
Broad and Vine Streets, MS 435  
Philadelphia, PA 19102  
215-762-1783

Hamot Medical Center-S  
201 State Street  
Erie, PA 16550  
814-455-6711

Hanover General Hospital-SB  
300 Highland Avenue  
Hanover, PA 17331  
717-637-3711

Harrisburg Hospital-SB  
South Front Street  
Harrisburg, PA 17101  
717-782-3131

Hazleton General Hospital-SB  
East Broad Street  
Hazleton, PA 18201  
717-450-4156

Health Network Laboratories-SB  
2024 Lehigh Street  
Allentown, PA 18103  
610-402-8150

Health Network Laboratories-S  
2545 Schoenersville Road  
Bethlehem, PA 18017  
610-861-2261

Highlands Hospital and Health Center-S  
401 East Murphy Avenue  
Connellsville, PA 15425  
412-628-1500

Holy Spirit Hospital-SB  
503 North 21st Street  
Camp Hill, PA 17011  
717-763-2206

Horizon Hospital System-Greenville Campus-SB  
110 North Main Street  
Greenville, PA 16125  
412-588-2100

Horizon Hospital System-Shenango Campus-SB  
2200 Memorial Drive  
Farrell, PA 16121  
412-981-3500

Indiana Hospital-Department of Lab Medicine-S  
P. O. Box 788  
Indiana, PA 15701  
724-357-7166

Jameson Memorial Hospital-S  
1211 Wilmington Avenue  
New Castle, PA 16105  
412-658-9001

J. C. Blair Memorial Hospital-S  
Warm Springs Avenue  
Huntingdon, PA 16652  
814-643-8645

Jeanes Hospital-S  
7600 Central Avenue  
Philadelphia, PA 19111  
215-728-2347

Jeannette District Memorial Hospital-S  
Jefferson Avenue  
Jeannette, PA 15644  
724-527-3551

Jefferson Regional Health Services, Inc.-Brookville Div.-S  
100 Hospital Road  
Brookville, PA 15825  
814-849-2312

John F. Kennedy Memorial Hospital-S  
Cheltenham Avenue and Langdon Streets  
Philadelphia, PA 19124  
215-831-7203

Kensington Hospital-S  
136 W. Diamond Street  
Philadelphia, PA 19122  
215-426-8100

LabOne, Inc.-SB  
10101 Renner Boulevard  
Lenexa, KS 66219  
913-888-1770

Lab Corp Occupational Testing Services, Inc.-SB  
4022 Willow Lake Blvd  
Memphis, TN 38118  
901-795-1515

Lab Corp. of America Holdings-SB  
69 First Avenue, P. O. Box 500  
Raritan, NJ 08869  
201-526-2400

Lab Corp. of America Holdings-SB  
6370 Wilcox Road  
Dublin, OH 43016  
800-282-7300

Laboratory Specialists, Inc.-B  
1111 Newton Street  
Gretna, Louisiana 70053  
504-361-8989

Lancaster General Hospital-S  
555 North Duke Street, P. O. Box 3555  
Lancaster, PA 17603  
717-299-5511

Lancaster General Hospital-Susquehanna Division-S  
306 North Seventh Street  
Columbia, PA 17512  
717-684-2841

Latrobe Area Hospital-B  
West Second Avenue  
Latrobe, PA 15650  
724-537-1550

Lewistown Hospital-S  
Highland Avenue  
Lewistown, PA 17044  
717-248-5411

Lock Haven Hospital-B  
24 Cree Drive  
Lock Haven, PA 17745  
717-893-5000

Main Line Clinical Laboratories-Bryn Mawr-CP-S  
Bryn Mawr Avenue  
Bryn Mawr, PA 19010  
610-526-3554

Main Line Clinical Laboratories-Lankenau-CP-S  
100 East Lancaster Avenue  
Wynnewood, PA 19096  
610-645-2615

Main Line Clinical Laboratories-Paoli Memorial-CP-S  
255 W. Lancaster Avenue  
Paoli, PA 19301  
610-648-1000

- Marian Community Hospital-S  
100 Lincoln Avenue  
Carbondale, PA 18407  
717-281-1042
- McKeesport Hospital Laboratory-S  
1500 Fifth Avenue  
McKeesport, PA 15132  
412-664-2233
- Meadville Medical Center-Liberty Street-S  
751 Liberty Street  
Meadville, PA 16335  
814-336-3121
- The Medical Center, Beaver, PA, Inc.-SB  
1000 Dutch Ridge Road  
Beaver, PA 15009  
724-728-7000
- Medical Center of Delaware-Department of Pathology-S  
4755 Ogletown-Stanton Road  
Newark, DE 19718  
312-733-3625
- Medical Center of Delaware-Department of Pathology-S  
501 W. 14th Street  
Wilmington, DE 19899  
302-733-3625
- Medical College of Pennsylvania Hospital-S  
3300 Henry Avenue  
Philadelphia, PA 19129  
215-842-6615
- MedTox Laboratories, Inc.-SB  
402 West County Road D  
St. Paul, MN 55112  
612-636-7466
- Memorial Hospital-SB  
325 South Belmont Street, P. O. Box 15118  
York, PA 17403  
717-843-8623
- Memorial Hospital Lab-SB  
1 Hospital Drive  
Towanda, PA 18848  
717-265-2191
- Mercy Health Laboratory, Mercy Fitzgerald Hospital-S  
Lansdowne Avenue and Bailey Road  
Darby, PA 19023  
610-237-4175
- Mercy Health Laboratory, Mercy Hospital/Philadelphia-S  
5301 Cedar Avenue  
Philadelphia, PA 19143  
215-748-9170
- Mercy Health Laboratory, Mercy Community Hospital-S  
2000 Old West Chester Pike  
Havertown, PA 19083  
610-645-3600
- Mercy Health Partners-S  
746 Jefferson Avenue  
Scranton, PA 18510  
717-348-7100
- Mercy Hospital-S  
Pride and Locust Streets  
Pittsburgh, PA 15219  
412-232-7831
- Mercy Hospital-S  
25 Church Street  
Wilkes-Barre, PA 18765  
717-826-3100
- Mercy Hospital-Nanticoke-S  
128 West Washington Street  
Nanticoke, PA 18634  
717-735-5000
- Mercy Providence Hospital Laboratory-S  
1004 Arch Street  
Pittsburgh, PA 15212  
412-323-5783
- Mercy Suburban Hospital-S  
2701 DeKalb Pike  
Norristown, PA 19404  
610-278-2075
- Methodist Hospital Division/TJUH, Inc.-S  
2301 South Broad Street  
Philadelphia, PA 19148  
215-952-9059
- MidValley Hospital-S  
1400 Main Street  
Peckville, PA 18452  
717-489-7546
- Miner's Hospital Lab of North Cambria-B  
2205 Crawford Avenue  
Spangler, PA 15775  
814-948-7171
- Monongahela Valley Hospital, Inc.-S  
Country Club Road, Route 88  
Monongahela, PA 15063  
412-258-2000
- Monsour Medical Center-S  
70 Lincoln Way East  
Jeannette, PA 15644  
724-527-1511
- Montgomery Hospital Laboratory-S  
Powell and Fornance Streets  
Norristown, PA 19401  
610-270-2173
- Moses Taylor Hospital-S  
700 Quincy Avenue  
Scranton, PA 18510  
717-963-2100
- Nason Hospital-B  
Nason Drive  
Roaring Spring, PA 16673  
814-224-6215
- National Medical Services, Inc.-Laboratory-SB  
3701 Welsh Road  
Willow Grove, PA 19090  
215-657-4900
- National Medical Services, Inc.-SB  
2300 Stratford Avenue  
Willow Grove, PA 19090  
215-784-1600
- Nazareth Hospital-S  
2601 Holme Avenue  
Philadelphia, PA 19152  
215-335-6245
- North Penn Hospital-S  
100 Medical Campus Drive  
Lansdale, PA 19446  
215-368-2100
- Northwest Medical Center-Franklin-S  
1 Spruce Street  
Franklin, PA 16323  
814-437-7000

Northwest Medical Center, Oil City Campus-SB  
174 East Bissell Avenue  
Oil City, PA 16301  
814-677-1711

Ohio Valley General Hospital-S  
Heckel Road  
McKees Rocks, PA 15136  
412-777-6244

Omega Medical Laboratories, Inc.-SB  
2001 State Hill Road, Suite 100  
Wyomissing, PA 19610  
610-378-1900

PA Department of Health, Bureau of Laboratories-SB  
P. O. Box 500  
Exton, PA 19341-0500  
610-363-8500

PA State Police Lab-Bethlehem-SB  
2932 Airport Road  
Bethlehem, PA 18017  
610-861-2103

PA State Police Lab-Erie-SB  
4310 Iroquois Avenue  
Erie, PA 16511  
814-899-8447

PA State Police Lab-Greensburg-SB  
P. O. Box P, PA State Police  
Greensburg, PA 15601  
724-832-3299

PA State Police Lab-Harrisburg-SB  
1800 Elmerton Avenue  
Harrisburg, PA 17110  
717-783-5548

PA State Police Lab-Lima-SB  
350 N. Middletown Road  
Media, PA 19063  
610-566-9066

PA State Police Lab-Wyoming-SB  
479 Wyoming Avenue  
Wyoming, PA 18644  
717-826-2230

Palmerton Hospital-S  
135 Lafayette Avenue  
Palmerton, PA 18071  
610-826-3141

Parkview Hospital-S  
1331 East Wyoming Avenue  
Philadelphia, PA 19124  
215-537-7430

Penn State-Geisinger WVMC-S  
1000 East Mountain Drive  
Wilkes-Barre, PA 18711  
717-826-7830

Philipsburg Area Hospital-SB  
210 Lock Lomond Road  
Philipsburg, PA 16866  
814-342-7112

Phoenixville Hospital Laboratory-S  
140 Nutt Road, Department of Pathology  
Phoenixville, PA 19460  
610-983-1612

Pinnacle Health/Community General Osteopathic  
Hospital-S

4300 Londonderry Road, P. O. Box 3000  
Harrisburg, PA 17109  
717-657-7214

Pittsburgh Criminalistics-SB  
1320 Fifth Avenue  
Pittsburgh, PA 15219  
412-391-6118

Pocono Medical Center Laboratory-SB  
206 East Brown Street  
East Stroudsburg, PA 18301  
717-476-3544

Polyclinic Hospital-S  
2601 North Third Avenue  
Harrisburg, PA 17110  
717-782-4141

Pottstown Memorial Medical Center-S  
1600 East High Street  
Pottstown, PA 19464  
610-327-7111

Pottsville Hospital and Warne Clinic-SB  
420 South Jackson Streets  
Pottsville, PA 17901  
717-621-5262

Presbyterian Medical Center of Phila.-S  
3400 Spruce Street, Dept. of Pathology  
Philadelphia, PA 19104  
215-662-3435

Quest Diagnostics of PA, Inc.-S  
900 Business Center Drive  
Horsham, PA 19044  
215-957-9300

Quest Diagnostics of PA, Inc.-SB  
875 Greentree Road  
4 Parkway Center  
Pittsburgh, PA 15220  
412-920-7600

Quest Diagnostics, Incorporated-SB  
One Malcolm Avenue  
Teterboro, NJ 07608  
201-288-0900

Reading Hospital and Medical Center-S  
Sixth and Spruce Streets  
Reading, PA 19611  
610-378-6080

Riddle Memorial Hospital-S  
Baltimore Pike Highway 1  
Media, PA 19063  
610-566-9400

Roxborough Memorial Hospital-S  
5800 Ridge Avenue  
Philadelphia, PA 19128  
215-483-9900

Sacred Heart Hospital-S  
Fourth and Chew Streets  
Allentown, PA 18102  
610-776-4727

Saint Agnes Medical Center-S  
1900 South Broad Street  
Philadelphia, PA 19145  
215-339-4100

Saint Clair Memorial Hospital-S  
1000 Bower Hill Road  
Pittsburgh, PA 15243  
412-561-4900

Saint Francis Hospital-S  
1000 South Mercer Street  
New Castle, PA 16101  
412-658-3511

Saint Joseph Hospital-S  
250 College Avenue, P. O. Box 3509  
Lancaster, PA 17604  
717-291-8022

Saint Lukes Hospital-S  
801 Ostrum Street  
Bethlehem, PA 18015  
610-691-4141

Saint Mary Medical Center-S  
Langhorne-Newtown Road  
Langhorne, PA 19047  
215-750-2162

Saint Vincent Health Center-S  
232 West 25th Street  
Erie, PA 16544  
814-452-5383

Sewickley Valley Hospital Laboratory-S  
Blackburn Road and Fitch Drive  
Sewickley, PA 15143  
412-741-6600

Shadyside Hospital-S  
5230 Centre Avenue  
Pittsburgh, PA 15232  
412-622-2315

Sharon Regional Health System-SB  
740 East State Street  
Sharon, PA 16146  
724-983-3911

Sierra Analytical Laboratories-SB  
625 East Drinker Street  
Dunmore, PA 18512  
717-341-2224

SmithKline Beecham Clinical Laboratories, Inc.-SB  
400 Egypt Road  
Norristown, PA 19403  
610-631-4200

Soldiers & Sailors Memorial Hospital-S  
Central Avenue  
Wellsboro, PA 16901  
717-724-1631

Somerset Hospital Laboratory-SB  
225 South Center Avenue  
Somerset, PA 15501  
814-443-2626

South Hills Health System-Jefferson-SB  
575 Coal Valley Road  
Pittsburgh, PA 15236  
412-469-5723

Southern Chester County Medical Center-S  
1015 West Baltimore Pike  
West Grove, PA 19390  
610-869-1080

Specialty Laboratories-SB  
2211 Michigan Avenue  
Santa Monica, CA 90404  
310-828-6543

St. Francis Central Hospital-S  
1200 Centre Avenue  
Pittsburgh, PA 15219  
412-562-3060

St. Francis Hospital-Cranberry-S  
One St. Francis Way  
Cranberry Township, PA 16066  
412-772-5300

St. Francis Medical Center-S  
400-45th Street  
Pittsburgh, PA 15201  
412-622-4838

St. Joseph Quality Medical Laboratory-SB  
215 North 12th Street, Box 316  
Reading, PA 19603  
215-378-2200

St. Joseph's Hospital-Div. of NPHS-S  
16th Street and Girard Avenue  
Philadelphia, PA 19130  
215-787-9000

St. Lukes Hospital-Allentown Campus-S  
1736 Hamilton Street  
Allentown, PA 18104  
610-439-4000

St. Lukes Quakertown Hospital-S  
Eleventh Street & Park Avenue, P. O. Box 9003  
Quakertown, PA 18951  
215-536-2400

St. Marys Regional Medical Center-B  
763 Johnsonburg Road  
St. Marys, PA 15857  
814-834-8519

Suburban General Hospital-S  
100 South Jackson Avenue  
Bellevue, PA 15202  
412-734-6000

Taylor Hospital Division of CCMC-S  
175 East Chester Pike  
Ridley Park, PA 19078  
610-595-6450

Temple East, Inc., NE-S  
2301 East Allegheny Avenue  
Philadelphia, PA 19134  
215-291-3671

Temple East, Inc.-NMC-S  
1741 Frankford Avenue  
Philadelphia, PA 19125  
215-291-2118

Temple Lower Bucks Hospital Lab-S  
501 Bath Road  
Bristol, PA 19007  
215-785-9200

Temple University Hospital-S  
3401 N. Broad Street  
Philadelphia, PA 19140  
215-221-3453

Thomas Jefferson University Hospital-S  
125 South 11th Street, 204 Pavillion  
Philadelphia, PA 19107  
215-955-6374

Titusville Area Hospital-S  
406 West Oak Street  
Titusville, PA 16354  
814-827-1851

Toxi-Con-SB  
120 Monahan Avenue, Suite 101  
Dunmore, PA 18512  
717-963-0722

Tyler Memorial Hospital-S  
RD #1, Route 6  
Tunkhannock, PA 18657  
717-836-2161

Tyrone Hospital-SB  
Clay Avenue Extension  
Tyrone, PA 16686  
814-684-1255

United Community Hospital-S  
631 North Broad Street Ext.  
Grove City, PA 16127  
412-458-5442

University Hospital-M.S. Hershey Medical Center-S  
500 University Avenue  
Hershey, PA 17033  
717-531-8353

University of Pittsburgh Medical Center/Beaver Valley-B  
2500 Hospital Drive-Pathology Dept.  
Aliquippa, PA 15001  
412-857-1238

University of Pittsburgh Medical Center-CLSI-S  
200 Lothrop Street, CLSI Room 5929 MT  
Pittsburgh, PA 15213  
412-647-7813

UPMC Bedford Memorial-SB  
10455 Lincoln Highway  
Everett, PA 15537  
814-623-3506

UPMC Lee Regional Hospital-SB  
320 Main Street  
Johnstown, PA 15901  
814-533-0130

UPMC Passavant-S  
9100 Babcock Boulevard  
Pittsburgh, PA 15237  
412-367-6700

UPMC Saint Margaret Hospital-S  
815 Freeport Road  
Pittsburgh, PA 15215  
412-784-4000

Warminster Hospital-S  
225 Newtown Road  
Warminster, PA 18974  
215-441-6700

Warren General Hospital-SB  
212 Crescent Park West  
Warren, PA 16365  
814-723-3300

Washington Hospital-S  
155 Wilson Avenue  
Washington, PA 15301  
412-225-7000

Wayne Memorial Hospital-S  
601 Park Street  
Honesdale, PA 18431  
717-253-1300

Waynesboro Hospital-SB  
East Main Street  
Waynesboro, PA 17268  
717-765-3403

West Virginia University Hospital-S  
Clinical Laboratories

1 Medical Center Drive, P. O. Box 8009  
Morgantown, WV 26506  
304-598-4241

Western Pennsylvania Hospital-S  
4800 Friendship Avenue  
Pittsburgh, PA 15224  
412-578-5779

Western Reserve Care System-SB  
500 Gypsy Lane  
Youngstown, OH 44504  
216-740-3794

Westmoreland Hospital-S  
532 W. Pittsburgh Street  
Greensburg, PA 15601  
412-832-4365

Williamsport Hospital and Medical Center-SB  
777 Rural Avenue  
Williamsport, PA 17701  
717-321-2300

Windber Medical Center-B  
600 Somerset Avenue  
Windber, PA 15963  
814-467-6611

WVHCS Hospital, General Campus-SB  
Corner North River and Auburn Streets  
Wilkes-Barre, PA 18764  
717-829-8111

York Hospital-SB  
1001 South George Street  
York, PA 17405  
717-771-2696

ROBERT S. ZIMMERMAN, Jr.,  
*Secretary*

[Pa.B. Doc. No. 99-1059. Filed for public inspection July 2, 1999, 9:00 a.m.]

## DEPARTMENT OF REVENUE

### Pennsylvania Bingo Doubler Instant Lottery Game

Under the State Lottery Law (72 P. S. §§ 3761-101—3761-314), and 61 Pa. Code § 819.203 (relating to notice of instant game rules), the Secretary of Revenue hereby provides public notice of the rules for the following instant lottery game:

1. *Name:* The name of the game is Pennsylvania Bingo Doubler.

2. *Price:* The price of a Pennsylvania Bingo Doubler instant lottery game ticket is \$2.00.

3. *Play Symbols:* Each Pennsylvania Bingo Doubler instant lottery game ticket will contain four play areas designated as "Card 1," "Card 2," "Card 3" and "Card 4." The 77 play symbols and their captions located in the four play areas are: The numbers 1 through 75, DBL and FREE. Each ticket will also contain a "Caller's Card" area. The "Caller's Card" area will consist of 30 squares in a 3 x 10 grid. The play symbols that may be located in each square are: The letter B with a number 1 through 15; the letter I with a number 16 through 30; the letter N

with a number 31 through 45; the letter G with a number 46 through 60; and the letter O with a number 61 through 75.

4. *Prizes:* The prizes that can be won in this game are \$2, \$4, \$5, \$10, \$20, \$100, \$250, \$500 and \$25,000. The player can win up to four times on a ticket.

5. *Approximate Number of Tickets Printed For the Game:* Approximately 9,000,000 tickets will be printed for the Pennsylvania Bingo Doubler instant lottery game.

6. *Determination of Prize Winners:*

(a) Holders of tickets matching the "Caller's Card" play symbols in an "X" extending through the "FREE" space and through to each of the four corners on "Card 4," shall be entitled to a prize of \$25,000.

(b) Holders of tickets matching the "Caller's Card" play symbols in an "X" extending through the "FREE" space and through to each of the four corners on "Card 3," shall be entitled to a prize of \$500.

(c) Holders of tickets matching the "Caller's Card" play symbols in a diamond pattern, matching one square in the midpoint in each of the four outside rows and columns, on "Card 4," shall be entitled to a prize of \$250.

(d) Holders of tickets matching the "Caller's Card" play symbols in an "X" extending through the "FREE" space and through to each of the four corners on "Card 2," shall be entitled to a prize of \$250.

(e) Holders of tickets matching the "Caller's Card" play symbols in an "X" extending through the "FREE" space and through to each of the four corners on "Card 1," shall be entitled to a prize of \$100.

(f) Holders of tickets matching the "Caller's Card" play symbols in a diamond pattern, matching one square in the midpoint in each of the four outside rows and

columns, on "Card 2" or "Card 3," shall be entitled to a prize of \$100.

(g) Holders of tickets matching the "Caller's Card" play symbols in a diamond pattern, matching one square in the midpoint in each of the four outside rows and columns, on "Card 1," shall be entitled to a prize of \$20.

(h) Holders of tickets matching the "Caller's Card" play symbols in the four corners on "Card 2," "Card 3" or "Card 4," shall be entitled to a prize of \$20.

(i) Holders of tickets matching the "Caller's Card" play symbols in the four corners on "Card 1," shall be entitled to a prize of \$10.

(j) Holders of tickets matching the "Caller's Card" play symbols in a five space horizontal, vertical or diagonal line with one of the five spaces in the line containing a DBL play symbol, on "Card 3," shall be entitled to a prize of \$10.

(k) Holders of tickets matching the "Caller's Card" play symbols in a five space horizontal, vertical or diagonal line on "Card 3," shall be entitled to a prize of \$5.

(l) Holders of tickets matching the "Caller's Card" play symbols in a five space horizontal, vertical or diagonal line with one of the five spaces in the line containing a DBL play symbol, on "Card 1," "Card 2" or "Card 4," shall be entitled to a prize of \$4.

(m) Holders of tickets matching the "Caller's Card" play symbols in a five space horizontal, vertical or diagonal line on "Card 1," "Card 2" or "Card 4," shall be entitled to a prize of \$2.

7. *Number and Description of Prizes and Approximate Odds:* The following table sets forth the approximate number of winners, amounts of prizes, and approximate odds of winning:

<i>Get Bingo With Prizes Of:</i>	<i>Win</i>	<i>Approximate Odds</i>	<i>Approximate No. of Winners Per 9,000,000 Tickets</i>
Line-Card 1	\$2	1:15	600,000
Line-Card 2	\$2	1:37.50	240,000
Line-Card 4	\$2	1:30	300,000
Line-Card 1 Doubler	\$4	1:75	120,000
Line-Card 2 Doubler	\$4	1:93.75	96,000
Line-Card 4 Doubler	\$4	1:107.14	84,000
Line-Cards 1 & 2	\$4	1:50	180,000
Line-Cards 2 & 4	\$4	1:75	120,000
Line-Card 3	\$5	1:30	300,000
Line-Cards 1, 2 & 4	\$6	1:50	180,000
Line-Card 3 Doubler	\$10	1:250	36,000
Corner-Card 1	\$10	1:375	24,000
Line-Cards 1, 2, 3 & 4	\$11	1:150	60,000
Corner-Card 2	\$20	1:375	24,000
Corner-Card 3	\$20	1:750	12,000
Corner-Card 4	\$20	1:750	12,000
Diamond-Card 1	\$20	1:750	12,000
Corner-Cards 1 & 4	\$30	1:895.52	10,050
Corner-Cards 1 & 3	\$30	1:895.52	10,050
Corner-Cards 3 & 4	\$40	1:4,000	2,250
Diamond-Card 1 + Corner-Card 4	\$40	1:6,000	1,500
Diamond-Card 2	\$100	1:12,000	750
Diamond-Card 3	\$100	1:12,000	750
X-Card 1	\$100	1:15,000	600
X-Card 2	\$250	1:120,000	75
Diamond-Card 4	\$250	1:120,000	75
X-Card 2 + Diamond-Card 4	\$500	1:40,000	225



<i>Get Bingo With Prizes Of:</i>	<i>Win</i>	<i>Approximate Odds</i>	<i>Approximate No. of Winners Per 9,000,000 Tickets</i>
X-Card 3	\$500	1:40,000	225
X-Card 4	\$25,000	1:750,000	12

8. *Retailer Incentive Awards:* The Lottery may conduct a separate Retailer Incentive Game for retailers who sell Pennsylvania Bingo Doubler instant lottery game tickets. The conduct of the game will be governed by 61 Pa. Code § 819.222 (relating to retailer bonuses and incentives).

9. *Unclaimed Prize Money:* For a period of 1 year from the announced close of Pennsylvania Bingo Doubler, prize money from winning Pennsylvania Bingo Doubler instant lottery game tickets will be retained by the Secretary for payment to the persons entitled thereto. If no claim is made within 1 year of the announced close of the Pennsylvania Bingo Doubler instant lottery game, the right of a ticket holder to claim the prize represented by the ticket, if any, will expire and the prize money will be paid into the State Lottery Fund and used for purposes provided for by statute.

10. *Governing Law:* In purchasing a ticket, the customer agrees to comply with and abide by the State Lottery Law (72 P. S. §§ 3761-101—3761-314), the regulations contained in 61 Pa. Code Part V (relating to State Lotteries) and the provisions contained in this notice.

11. *Termination of the Game:* The Secretary may announce a termination date, after which no further tickets from this game may be sold. The announcement will be disseminated through media used to advertise or promote Pennsylvania Bingo Doubler or through normal communications methods.

ROBERT A. JUDGE, Sr.,  
*Secretary*

[Pa.B. Doc. No. 99-1060. Filed for public inspection July 2, 1999, 9:00 a.m.]

## DEPARTMENT OF TRANSPORTATION

### Multijurisdictional Permit Agreement

Notice is hereby given by the Department of Transportation, under the authority contained in Section 6146.1 of the Vehicle Code, Act of June 17, 1976, P. L. 162, No. 81, as amended by the Act of April 29, 1994, P. L. 148, No. 28 (75 Pa.C.S. § 6146.1), that the Department, on behalf of the Commonwealth of Pennsylvania, has executed a Memorandum of Understanding (MOU) with the Northeast Association of State Transportation Officials (NASTO) and has thereby joined as a participating member of the NASTO system for regional overweight and oversize trip permits for vehicles with nondivisible loads. The MOU was adopted by the NASTO Highway Transport Committee on January 28, 1993, and was amended on October 16, 1996. The participating NASTO States who have executed the MOU have agreed to consider proposals, beginning on January 4, 1999, from permit services. Permit services that the participating NASTO States have authorized may then apply for and compile NASTO multijurisdictional permits and amendments (i.e., supplements). This authorization process is

expected to last approximately sixty days before the Department will issue any permits under terms of the NASTO MOU. However, the Department will issue no multijurisdictional permit until this notice is published in the *Pennsylvania Bulletin*.

The NASTO MOU establishes a formal agreement for processing permit applications for oversize or overweight combinations with nondivisible loads among participating jurisdictions within the NASTO region that propose to cross participating state borders. The MOU also establishes conditions of movement under the permit. Other states, provinces and jurisdictions within the NASTO region that have executed or will execute the MOU by November 1999, include Maryland, Delaware, New Jersey, New York, and Ontario. States, provinces and jurisdictions within the NASTO region that have not yet agreed to execute the MOU include Connecticut, Puerto Rico, Quebec, New Brunswick, Nova Scotia and Newfoundland. New York City and Washington, D.C. are exploring the possibility of executing the MOU. The states of Rhode Island, Massachusetts, Vermont, New Hampshire and Maine have executed the MOU but they have not yet decided whether or when they will abandon their long-existing New England Transportation Consortium (NETC) agreement for issuing oversize/overweight permits for multi-state movements.

In accordance with Section 6146.1(b) of the Vehicle Code, the MOU executed by the Secretary of Transportation has been drafted to be in the best interest of this Commonwealth and its citizens. The MOU is fair and equitable to this Commonwealth and its citizens. The MOU will benefit the economy of this Commonwealth by facilitating the uninterrupted flow of commerce, and will continue to preserve the safety of the motoring public, the orderly movement of traffic and the structural integrity of the highways.

Section 6146.1(c) of the Vehicle Code provides for enforcement of the provisions of the executed MOU and the multijurisdictional permit. Multijurisdictional permits will be enforced in Pennsylvania in the same manner as any other oversize or overweight permits issued under authority of Chapter 49 of the Vehicle Code and Chapter 179 of Department Regulations (67 Pa. Code, Chapter 179). Relevant rules contained in the MOU and its appendices are in addition to current Federal and State laws and regulations governing the movement of oversize or overweight vehicles, combinations and loads.

Section 6146.1 (d) of the Vehicle Code requires that, to implement this law and the provisions of a multijurisdictional permit agreement, the Secretary shall publish the agreement and relevant rules as a notice in the *Pennsylvania Bulletin*. Accordingly, a copy of the MOU executed by the Department and relevant rules are included in this notice. The Department will also post a copy of the current MOU and relevant rules on the Internet at the following Department address: [www.dot.state.pa.us](http://www.dot.state.pa.us). The MOU can then be viewed at this site by clicking on "Roads and Highways," then "Permits," then "Hauling Permits," then "NASTO."

Under this MOU, an authorized permit service must submit an application for a NASTO Multijurisdictional

permit. In Pennsylvania, the permit service must apply via the Internet. The permit service may submit an application for a motor carrier having a combination with sizes and weights that do not exceed the envelope vehicle limitations contained in Appendix A of the MOU. Currently, the NASTO envelope vehicle has the following maximum limits: 90 feet in length, 14 feet in width, 14 feet, six inches in width at the roof eave of a manufactured housing unit, 13 feet, six inches in height, 3 foot front load overhang, 108,000 pounds gross weight on a five-axle combination, 120,000 pounds gross weight on a combination with six or more axles, 6,000 to 12,000 pounds on a steering axle, 25,000 pounds on any other single axle, 25,000 pounds on each axle in a two-tandem axle group (commonly called tandem axles), 20,000 pounds on each axle in a three-tandem axle group (commonly called tridem axles), 600 pounds per inch of nominal tire width or the tire manufacturer's ratings, whichever is less, and at least four tires on all nonsteering axles. In addition, retractable or variable load suspension axles may not be counted as axles nor will they be considered capable of carrying any load. Only a nondivisible load being hauled on a combination will qualify for a NASTO multijurisdictional permit.

Appendix B of the MOU will be used by participating jurisdictions as a member jurisdiction point-of-contact list in the future. Appendix B will contain no relevant rules and, therefore, does not need to be published as a notice when NASTO develops it.

Combinations operating under authority of a multijurisdictional permit will be subject to both the common safety standards contained in Appendix C of the MOU and 67 Pa. Code, Chapter 179. Additionally, Department Form M-938 shall be in the driver's possession along with the multijurisdictional permit when operating a permitted vehicle along Pennsylvania State highways. Department Form M-938 is a document that includes Sections 179.10 and 179.11 from 67 Pa. Code, Chapter 179 and a map that governs authorized travel periods within urbanized areas designated on the map. It is important that the driver know and comply with this information to promote safe movement.

Under this MOU, multijurisdictional permits will be submitted only by permit services who have executed an agent agreement and form identified in Appendix D and Appendix D-1 of the MOU. Once each participating jurisdiction issues their permit, the authorized permit service will compile these permits on a permit form identified in Appendix D-2 of the MOU. These permit services will also be authorized to compile amendments (or supplements) to the multijurisdictional permits on an amendment form identified in Appendix D-3 of the MOU, after the request is approved by each participating jurisdiction.

It is anticipated that the NASTO MOU will be amended as participating jurisdictions gain experience in administering the provisions of the MOU. The Department intends to publish future notices as relevant rules are modified by the participating NASTO jurisdictions.

Questions, comments, or suggestions may be forwarded to Mr. Walter Knerr, Permit Manager, P. O. Box 8210, Harrisburg, PA 17105-8210, (717) 783-6473.

BRADLEY L. MALLORY,  
*Secretary*

N A S T O  
MEMORANDUM OF UNDERSTANDING  
for

Regional Overweight and Over-Dimensional Trip Permits  
for Vehicles with Nondivisible Loads

Adopted by NASTO Highway Transport Committee on:  
January 28, 1993

Amended: October 16, 1996

ENDORSEMENT PAGE

We, the undersigned, endorse and subscribe to the common set of procedures described in this Memorandum of Understanding for the issuance of one way single trip permits for nondivisible oversize and overweight loads on vehicles engaged in interstate, inter-provincial or international travel to the extent such travel is within the boundaries of our respective Jurisdictions, effective as of the date noted below:

Jurisdiction	Chief Adm. Officer/designee	
_____	_____	_____ Date
_____	_____	_____ Date
_____	_____	_____ Date

1.0 INTRODUCTION

Governmental agencies and the trucking industry in the United States and Canada have recognized the need for uniformity and simplification of procedures for the regulation, registration, taxation or permitting of trucks involved in interstate, inter-provincial or international travel. The Federal Highway Administration (FHWA) and the American Association of State Highway and Transportation Officials (AASHTO) have identified the issuance of overweight and over-dimensional one way, single trip permits for vehicles carrying nondivisible loads in interstate travel as a matter of high priority for improvement through the development of procedures for the issuance of permits on a regional basis. All of the regional organizations of AASHTO, including the Northeastern Association of State Transportation Officials (NASTO) have developed or are developing such procedures.

This Memorandum of Understanding (MOU) sets forth the procedures and applicability of the regional permitting arrangement developed by the northeastern states and adjacent provinces through the NASTO Highway Transport Committee.

2.0 PURPOSE, SCOPE AND GOAL/OBJECTIVE OF THIS MOU

2.1 Purpose

The purpose of this MOU is to provide for the issuance and processing of one way, single trip overweight and over-dimensional permits for Envelope Vehicles with Nondivisible Loads engaged in interstate, inter-provincial or international travel on designated routes in or between the northeast states and/or adjacent provinces.

2.2 Scope

This MOU applies only to the issuance of one way, single trip permits for vehicles with Nondivisible Loads that are within the limits of the Envelope Vehicle, as defined herein, on the network of highways designated or approved for such travel by the jurisdictions that are parties to this MOU.

### 2.3 Goal/Objective

The longer term goal of the jurisdictions entering into this MOU is the implementation of a formal agreement for the issuance of NASTO regional trip permits on an ISSUING JURISDICTION basis, as defined herein, after the future development of required common procedures and supporting systems as described in Article 5.0. The immediate objective of this MOU is to provide an interim alternative method for issuance of permits authorizing trips through several jurisdictions on a timely basis, and to utilize a common set of safety standards for permitted travel in all Participant Jurisdictions.

### 3.0 DEFINITIONS

The definitions below are in relation to the use of these terms in connection with this MOU, including those required in the future for the issuance of permits on an "Issuing Jurisdiction" basis, as described in Article 5.0.

**3.1 Access Highway(s)**—Highways connecting the points of origin and destination for nondivisible oversize or overweight loads with the regional highway network, within the boundaries of a participant jurisdiction.

**3.2 Axle**—The common axis of rotation of two or more wheels extending the full width of the vehicle, whether power driven or freely rotating, and whether in one or more segments, and regardless of the number of wheels carried thereon.

**3.3 Envelope Vehicle**—A combination vehicle with specific limits as to length, height, width, gross weight, axle spacing, axle weight, and tire load. The limits for the NASTO envelope vehicle are established based on the maximum limits that can be routinely permitted in all of the Participant Jurisdictions. The NASTO envelope vehicle applicable to this MOU is described in APPENDIX A, following hereto.

**3.4 Gross Weight**—The weight of any vehicle without load, plus the weight of any load thereon.

**3.5 Height**—The total vertical dimension of any vehicle above the ground surface including any load or load-holding device thereon.

**3.6 Issuing Jurisdiction**—The one jurisdiction that will approve and issue, and collect all applicable fees for a NASTO regional trip permit for a vehicle within the limitations of the Envelope Vehicle with a nondivisible load, on behalf of all jurisdictions included in the routing for the permit. (NOTE-The issuance of NASTO regional permits on an issuing jurisdiction basis is a longer term goal of this MOU as described in Article 5.0 Future Development).

**3.7 Length**—The total longitudinal dimension of any vehicle, including any load or load-holding devices thereon.

**3.8 Nondivisible load**—Any vehicle, or any load with carrying vehicle heavier, longer or wider than the legal limit, that cannot be separated into two or more lighter or smaller components without destroying the value of the shipment. A containerized load is considered nondivisible only if the content of the container is identified, is separately indivisible and cannot be separated into two or more lighter or smaller components without destroying the value of the shipment.

**3.8A Overhang**—Overhang means the distance from the front/rear of the vehicle or combination vehicle exclusive of load, to the frontmost or rearmost part of the load.

**3.9 Participant jurisdictions**—States, Provinces, or other authorities that have signed this MOU.

**3.10 Permittee**—Any person(s), company, corporation or legal entity responsible for the movement of any oversize or overweight vehicle or load in accordance with the provisions of this MOU.

**3.11 Regional Highway Network**—Routes selected and approved by each participant jurisdiction over which envelope vehicles are permitted to travel in accordance with the provisions of this MOU.

**3.12 Single Axle**—An axle with two or more wheels, whose centers are in one transverse plane, which is not a steering axle.

**3.13 Steering Axle**—The axle or axles of a combination of vehicles which is guided or steered.

**3.14 Tandem Axles**—Any two consecutive axles, excluding retractable or variable load suspension axles, whose centers are at least 48 inches, but not more than 96 inches apart, and are individually attached to and/or articulated from a common attachment to the vehicle including a connection mechanism designed to equalize the load between axles.

**3.15 Tridem Axles**—Any three consecutive axles, excluding retractable or variable load suspension axles, whose extreme centers are not more than 144 inches apart, with individual centers at least 48 inches apart, and are individually attached to a common attachment to the vehicle including a connecting mechanism designed to equalize the load among axles.

**3.16 Retractable or variable load suspension axles** - Axles which can be regulated by the driver of the vehicle. These axles are controlled by hydraulic and air suspension systems, mechanically, or by a combination of these methods.

**3.17 Width**—The total outside transverse dimension of a vehicle including any load or load-holding devices thereon, excluding approved safety devices and tire bulge due to load.

### 4.0 PERMITTING PROCEDURES

#### 4.1 Interim procedures

As an interim method for providing NASTO Regional trip permits covered by this MOU, each Participant Jurisdiction will accept permit applications in accordance with their procedures. Each Participant Jurisdiction will continue to approve and issue permits and to enforce its laws and regulations governing all permitted movements within its boundaries, and to collect permit fees directly from the permittee or FAX companies/permit agents in accordance with currently existing procedures. Therefore, each Participant Jurisdiction will continue to receive revenues for permitted travel within its boundaries on the same basis that existed prior to this MOU.

#### 4.2 Timeliness of permit issuance

Participant Jurisdictions agree that four (4) hours is a reasonable turnaround time for permits issued pursuant to this MOU and will use their best efforts to approve permit applications within that time frame, from the time a request is received, subject to the normal days and hours of operation of the issuing jurisdiction.

**4.3 Permits for routes on turnpikes, toll roads or bridges, local highways, and roads and streets or other facilities not under the authority of the Participant Jurisdictions**

If a particular trip permit requires the use of a turnpike, toll road, bridge, tunnel or local highways, roads and streets or other facilities not under the author-

ity of the Participant Jurisdiction, the permittee, or his agent must obtain those permits as may be required, in the same manner as under previously existing procedures.

#### 4.4 Establishment and collection of permit fees

Each Participant Jurisdiction will continue to establish and collect its own fees.

#### 4.5 Common safety standards

Safety standards related to the issuance of truck permits are set forth in Appendix C.

#### 4.6 Notifications

If notifications are to be made to or from Participant Jurisdictions for any matters related to the issuance of permits, such notifications will be made by letter, facsimile transmission (FAX), telephone call, or other accepted method of communication to the person designated by each Participant Jurisdiction for that purpose as set forth in Appendix B, attached hereto and made a part hereof. Changes in the names of the designated officials or other information on Appendix B will be forwarded to the official designated for the Delaware Department of Transportation for distribution to all other Participant Jurisdictions.

### 5.0 FUTURE DEVELOPMENT

The Participant Jurisdiction will continue to cooperate in the designation of a Regional Highway Network and in the development of common procedures and supporting systems required for the issuance of trip permits on an Issuing Jurisdiction basis, as defined herein.

#### 5.1 Designation of Regional Highway Route Network

Participant Jurisdictions will identify the highways within their boundaries over which Envelope Vehicles will be permitted to travel in accordance with a future regional permitting agreement.

A NASTO Regional Highway Network map (NOOPA Form 2), excluding access routes, will be developed and included in a future regional permitting agreement. An appendix to that agreement will identify and describe current restrictions and conditions that are in place on the regional network, as of its effective date. Each time a temporary restriction must be put into effect, or to remove a restriction from the map, or to amend the identified routes and/or the restrictions or limitations thereon, the designated officials for the applicable Participant Jurisdiction will notify all other Participant Jurisdictions as quickly as possible of that change, by forwarding such information in writing, or by facsimile transmission, to the officials designated by each of the other Participant Jurisdictions to be identified in an appendix to a future regional permitting agreement.

5.2 Common procedures and supporting systems required for issuance of permits on an Issuing Jurisdiction basis:

- continued use of the uniform permit form acceptable to all Participant Jurisdictions (NOOPA Form 1);
- establishment of a Regional Highway Route network over which any Participant Jurisdiction may issue permits;
- establishment of a permit amendment procedure;

- communication systems for advising all other Participant Jurisdictions of highway construction work zone limitations or detours on a current basis;

- computerized systems for permit routing and accounting for permit fees collected on behalf of other jurisdictions;

- notification on a timely basis to applicant and to all affected Participant Jurisdictions of permits approved by an Issuing Jurisdiction for travel within their boundaries;

- timely settlement or exchanges of permit fees collected including documentation for audit verification by comparison to listings of permits issued;

- development of a manual of administrative or operating standards and procedures, including days and hours of operations, arrangements for holidays, permit office locations and telephone numbers;

- accommodation of individual jurisdiction requirements;

- consideration of legal liability issues and development of model legislation as may be required by the individual Participant Jurisdictions;

- consideration of standardized enforcement policies;

- establishment of a governing body to resolve administrative matters.

### 6.0 PROCEDURES FOR ENTERING INTO OR WITHDRAWAL FROM THIS MOU

A jurisdiction desiring to become a participant in this MOU may make arrangements through the chairperson of the NASTO Highway Transport Committee to affix the signature of its chief administrative officer, or other properly authorized official to the original signed copy of this MOU which is on file with the Committee.

A jurisdiction may withdraw as a participant in this MOU by giving at least three months advance notice to all other Participant Jurisdictions. However, withdrawal by one jurisdiction will not invalidate this MOU for the other participants.

### 7.0 CHANGES TO APPENDICES

Recognizing that safety rules and regulations and the detailed description of the Envelope Vehicle along with any required appurtenances may alter as innovations occur or experience dictates, it is agreed that changes in the appendices will be permitted without the need to amend this Memorandum of Understanding (MOU) under the following two conditions:

1) The designated official for each participating jurisdiction on the NASTO Highway Transport Committee for those jurisdictions who have signed the MOU shall be authorized to approve changes to the appendices of this document without requiring any additional approvals.

2) To protect each jurisdiction, any changes made to the appendices must be by unanimous consent of the designated officials for jurisdictions participating in the MOU.

**APPENDIX A**

**NASTO ENVELOPE VEHICLE CONFIGURATIONS  
FOR NON-DIVISIBLE OVERSIZE AND/OR OVERWEIGHT PERMIT TRIPS**

**CONFIGURATIONS  
FOR VEHICLES  
W/NON-DIVISIBLE LOADS  
THAT ARE  
OVERSIZE ONLY  
(LEGAL WEIGHT)\*\***

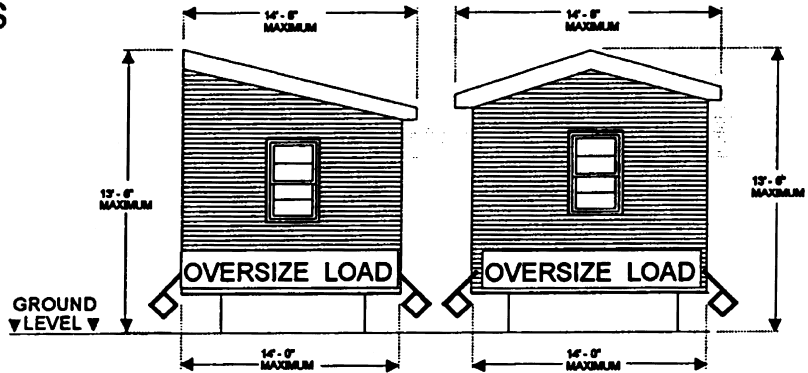

**MAXIMUM SIZE LIMITS:**

- LENGTH: 90'-0" OR LESS
- HEIGHT: 13'-6" OR LESS
- WIDTH: 14'-0" OR LESS

FOR MODULAR AND MOBILE HOMES, AN ADDITIONAL 6 INCHES OF OVERHANG FOR EAVE(S) ONLY WILL BE ALLOWED PROVIDING THE GREATER OVERHANG IS ON THE RIGHT-HAND SHOULDER SIDE OF THE HIGHWAY.

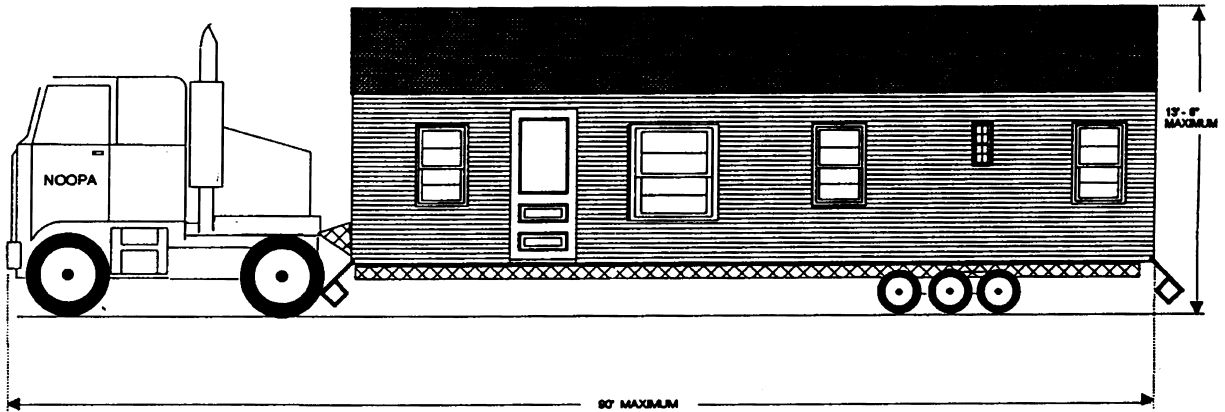

**\*\* LEGAL WEIGHT IS DEFINED TO BE A VEHICLE WITH LOAD THAT MEETS THE BRIDGE FORMULA AND INTERSTATE AXLE AND GROSS WEIGHT LIMITS AS SET FORTH IN SECTION 127 of the UNITED STATES CODE TITLE 23**

**OTHER RESTRICTIONS:**

1. FRONT OVERHANG, IF ANY, SHALL NOT EXCEED 3' 0" FROM FRONT BUMPER.
2. MAXIMUM WEIGHT ON TIRES SHALL NOT EXCEED THE LESSER OF EITHER 600 LBS PER INCH OF NOMINAL TIRE WIDTH OR THE MANUFACTURER'S RATINGS.
3. RETRACTABLE OR VARIABLE LOAD SUSPENSION AXLES SHALL NOT BE COUNTED AS AXLES NOR SHALL THEY BE CONSIDERED CAPABLE OF CARRYING ANY LOAD.

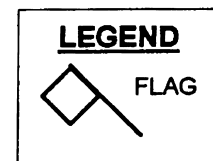

**CONFIGURATIONS  
FOR VEHICLES  
W/NON-DIVISIBLE LOADS  
THAT ARE  
OVERWEIGHT  
OR  
OVERSIZE AND OVERWEIGHT**

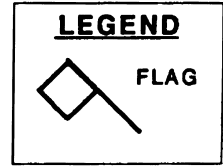
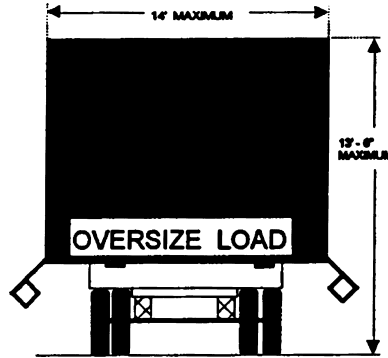

**MAXIMUM GROSS WEIGHT LIMITS:**

108,000 LBS. ON VEHICLES WITH FIVE AXLES  
120,000 LBS. ON VEHICLES WITH SIX OR MORE AXLES  
(SEE MINIMUM AXLE SPACING AND MAXIMUM AXLE WEIGHTS BELOW)

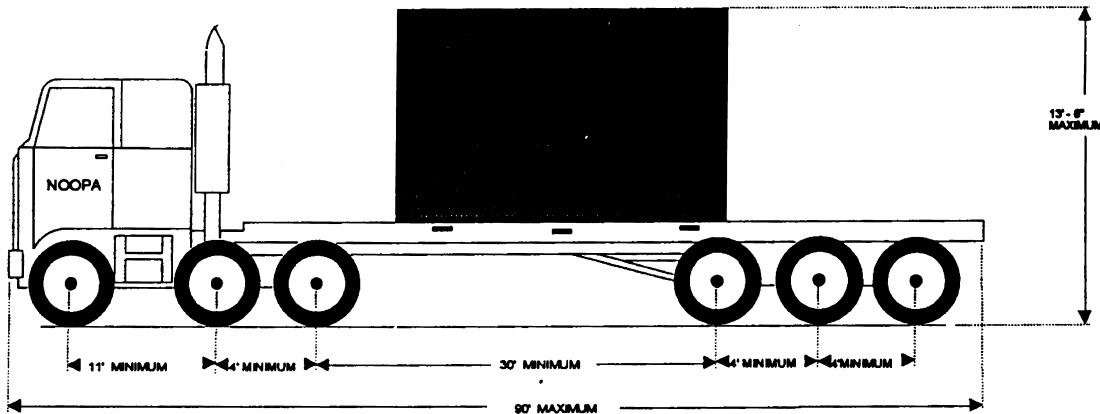
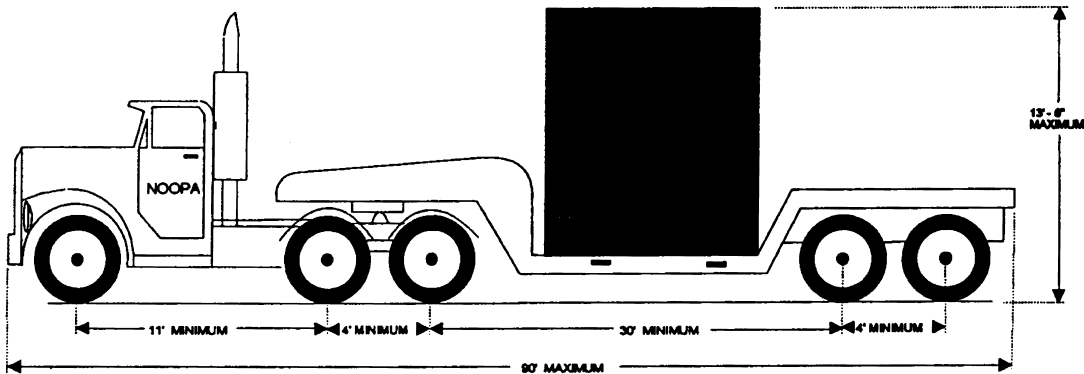

**NOTE:** VEHICLES WITH THE TANDEM AND TRIDEM AXLES INTERCHANGED ARE ACCEPTABLE UNDER THE SAME AXLE SPACING AND WEIGHT GUIDELINES.

**AXLE WEIGHT RESTRICTIONS:**

MAX. WEIGHT ON SINGLE AXLE = 25k EXCEPT FOR STEERING AXLE:  
MAX. WEIGHT ON STEERING AXLE = 12k MAX., 6k MIN.  
MAX. WEIGHT ON TANDEM = 25k/AXLE  
MAX. WEIGHT ON TRIDEM = 20k/AXLE

**OTHER RESTRICTIONS:**

1. FRONT OVERHANG, IF ANY, SHALL NOT EXCEED 3' 0" FROM FRONT BUMPER.
2. MAXIMUM WEIGHT ON TIRES SHALL NOT EXCEED THE LESSER OF EITHER 600 LBS PER INCH OF NOMINAL TIRE WIDTH OR THE MANUFACTURER'S RATINGS.
3. RETRACTABLE OR VARIABLE LOAD SUSPENSION AXLES SHALL NOT BE COUNTED AS AXLES NOR SHALL THEY BE CONSIDERED CAPABLE OF CARRYING ANY LOAD.
4. ALL AXLES (EXCEPT STEERING AXLE) SHALL HAVE A MINIMUM OF FOUR(4) TIRES.

## APPENDIX C

## COMMON SAFETY STANDARDS

## C.1 INTRODUCTION

Participating NASTO states and provinces have adopted the following common safety standards for use by permittees when in transit within their respective jurisdictions.

The safety standards have been adapted from the "Guide for Maximum Dimensions and Weights of Motor Vehicles and for the Operation of Nondivisible Load Oversize and Overweight Vehicles" prepared by the Subcommittee on Highway Transport and officially adopted by the American Association of State Highway and Transportation Officials (Revised November 1991). To help cross reference AASHTO's publication, AASHTO's numbering system is included parenthetically.

## C.2 DAYS AND HOURS OF OPERATION (AASHTO 3.05)

Permitted vehicles may move Monday through Friday, from sunrise to sunset, unless otherwise authorized or prohibited by this section or the permit.

Individual jurisdictions may authorize overweight vehicles that are not overdimensional to move within their jurisdiction between sunset and sunrise if the overweight vehicle can flow with traffic.

Individual jurisdictions may authorize permitted vehicles to move within their jurisdiction at other times, subject to permit requirements.

Individual jurisdictions may authorize permitted vehicles to move within their jurisdiction an additional thirty (30) minutes before sunrise and/or after sunset.

In designated congested areas, individual jurisdictions may prohibit permitted vehicles from moving during AM and/or PM commuter travel periods; and/or authorize permitted vehicles to move during designated times between sunset and sunrise, subject to special lighting requirements identified in section C.8

Due to the amount of highway traffic on holidays, vehicles and loads requiring oversize and/or overweight permits shall be prohibited from traveling on those days. Prohibited holidays include New Year's Day, Memorial Day, Independence Day, Labor Day, Thanksgiving Day, and Christmas. Movement of such vehicles and loads may also be prohibited on any other days or hours when such movements may substantially affect the safety or the motoring public.

## C.3 INCLEMENT WEATHER (AASHTO 3.06)

No movement shall be permitted when road conditions, weather conditions, or visibility make traveling hazardous to the operator or the driving public. If a permitted vehicle is underway when such conditions occur, the driver shall be required to proceed to a safe place off the roadway and park until conditions warrant safe travel.

## C.4 SPEED LIMITS (AASHTO 3.07)

Vehicles and loads requiring permits may travel at the posted maximum speed limits unless specifically prohibited by the permit.

## C.5 ROUTING (AASHTO 3.08)

The permit shall authorize movement only on the pavement portion of those highways specified in the permit which are on the jurisdictions' highway systems. The permit does not authorize movement upon shoulders.

Vehicles and loads requiring permits should be routed around highway construction and maintenance projects and shall be routed around certain bridges or roadways in a way that creates the least hazard and inconvenience to both the mover and the public.

The permit is only for the route designated. Individual jurisdictions' rules/regulations govern movement off the permitted route.

Each jurisdiction in conjunction with its bordering jurisdictions may work to establish mutually acceptable connecting routes.

Every effort should be made to use the most suitable road network which is closest to a straight line projected between the point of origin and final designation of the load. Only one international crossing shall be authorized unless agreed to by all affected jurisdictions.

## C.6 ESCORTS (AASHTO 3.10)

Escort vehicles shall be a single unit nonpermitted vehicle, no smaller than a compact car. The escort vehicle shall not be attached to any other vehicle.

Escort vehicle(s) shall escort only one oversize vehicle or load. Jurisdictions may require more restrictive conditions on high volume highways or when the lane width is less than twelve (12) feet.

One escort vehicle is required for vehicles and loads more than twelve (12) feet in width. The escort vehicle shall be behind an overwidth vehicle or load on a multi-lane highway, and in front of an overwidth vehicle or load on a two-lane highway.

Envelope Vehicles and loads eighty (80) feet or more in overall length are required to have one (1) rear escort vehicle on two lane highways.

Envelope Vehicles and loads with fifteen (15) feet or greater rear overhang shall have one (1) rear escort regardless of road type.

Two (2) escort vehicles, one (1) in front and one (1) behind the oversize vehicle are required when previous paragraphs separately require one (1) escort in the front and one (1) behind for multiple conditions.

Vehicles and loads that are only overweight or are twelve (12) feet or less in width and that cannot move freely with the flow of traffic may be subject to escort requirements.

Escort Vehicles shall have visual contact with the permitted vehicle and have two-way radio communication with the driver of the permitted vehicle.

## C.7 WARNING FLAGS (AASHTO 3.11)

Required warning flags shall be in evidence during daylight hours. Red or orange fluorescent warning flags shall be at least eighteen (18) inches square. Flags shall be securely fastened to the vehicle or load by at least one corner of the flag or securely mounted on a staff.

Warning flags are required on vehicles and loads which exceed legal width. These vehicles and loads are required to bear flags at the extremities of the vehicle or load as shown in Figure C-1.

Flags are also required on vehicles and loads which exceed legal length or which have a rear overhang in excess of four (4) feet. There shall be a single flag at the extreme rear if the overlength or projecting portion is two (2) feet wide or less. Two (2) flags are required if the

overlength or projecting portion is wider than two (2) feet and shall be located to indicate maximum width. (See Figure C-2)

#### C.8 WARNING LIGHTS (AASHTO 3.12)

##### General Lighting Requirements

(i) Load hauling vehicles and escort vehicles shall travel with low beam headlights on at all times.

(ii) Load hauling vehicles may be required to display a flashing 360 degree yellow (amber) light at an elevation above the highest point of the vehicle. A second flashing 360 degree light may be required at the rear of the load if the load obstructs the visibility of the 360 degree light on the load hauling vehicle. The 360 degree light shall be visible in all directions from a distance of 1,000 feet during daylight hours with a flash rate of 60 to 90 flashes per minute (FPM). The 360 degree light lens shall be at least 4 inches high whose minimum width or diameter at that height is 4 3/4 inches.

(iii) Warning lights for escort vehicles shall be located on the roof of the vehicle perpendicular to the length of the escort vehicle. The warning light bar shall be a minimum of 43 inches and a maximum of 52 inches long, a minimum of 10 inches and a maximum of 13 inches wide, and a minimum of 4 inches with a maximum of 8 inches high, consisting of flashing or strobe lights. Each warning light bar shall consist of a minimum of four lights. If flashing lights are used, they shall consist of at least two 95 and two 150 minimum FPM rotators; mirrors shall be placed diagonally between lights (mirrors to be reflective on both sides). All lights shall be visible on a 360 degree basis from the vehicle for a distance of 1,000 feet and arranged with at least two lights in each end of the bar light. The dome cover color shall be amber. New Jersey requires that the bar light not be illuminated while in New Jersey.

(iv) Whenever the rear running lights, stop lights, turn signals, or hazard warning lights are obstructed by the load on a vehicle, lighting equipment shall be displayed on the rear of the load equivalent to the obstructed lights or signals.

##### Load Warning Lights

Warning lights shall be used for authorized night operations as shown in Figures C-3 and C-4.

(i) For overwidth loads uniform in width, place amber lights on the forward corners of the load and red lights on the rear corners of the load as shown in Figure C-3.

(ii) If the load is overwidth for its entire length with a wider portion near the middle of the load, place red and amber lights at the rear and front corners of the load,

respectively, with amber lights on the sides at the extreme limits of the load as shown in Figure C-3.

(iii) If the load is nonuniform in width, place red and amber lights at the rear and front corners, respectively of the overwidth portion as shown in Figure C-3.

(iv) For loads of legal width that are overlength with a rear overhang exceeding four (4) feet, place four red lights on the rear and sides of the overhanging portion of the load. Amber lights are required at least every 6 feet on both sides of the overhang as shown in Figure C-4.

#### C.9 WARNING SIGNS (AASHTO 3.13)—WITHIN U.S.

Warning signs shall be in evidence during all oversize movements. In the U.S., load hauling vehicle warning signs shall be at least seven (7) feet long and eighteen (18) inches high. The sign's background shall be yellow with black lettering, and for night moves, of high-intensity reflective material. Letters shall be at least ten (10) inches high with a 1.41 inch brush stroke. Note: If Series E Modified is used, the brush stroke is to be two (2) inches. In Canada, the "D" sign shall be used.

Vehicles and loads exceeding legal width shall display two signs with the wording "OVERSIZE LOAD" (In Canada, "D"). One sign shall be on the front of the vehicle. The other shall be on the rear of the load; however, if the sign cannot be attached to, or is not legible on the load, then the sign shall be attached to the rear of the vehicle itself. Refer to Figure C-5.

Vehicle and loads exceeding legal length or rear overhang shall be required to display two signs with the wording "OVERSIZE LOAD" (In Canada, "D"). One sign shall be on the rear of the overlength or overhanging part of the load; however, if the sign cannot be attached or is not legible here, then the sign shall be attached to the rear of the vehicle itself. The other sign shall be attached to the front of the vehicle. Refer to Figure C-6.

Escort vehicles shall display a sign on the roof or front and rear of the escort vehicle that is at least five (5) feet long and twelve (12) inches high with eight (8) inch high letters. For roof mounted signs, the sign shall be legible on both sides with the wording "OVERSIZE LOAD" (In Canada, "D"). The sign shall be mounted on the roof perpendicular to the length of the escort vehicle. For front and rear mounted signs the legend shall read "OVERSIZE LOAD" (In Canada, "D").

Warning signs shall not obstruct lights and other safety devices on the vehicle with load or on the escort vehicle.



# APPENDIX C Common Safety Standards for Permit Move

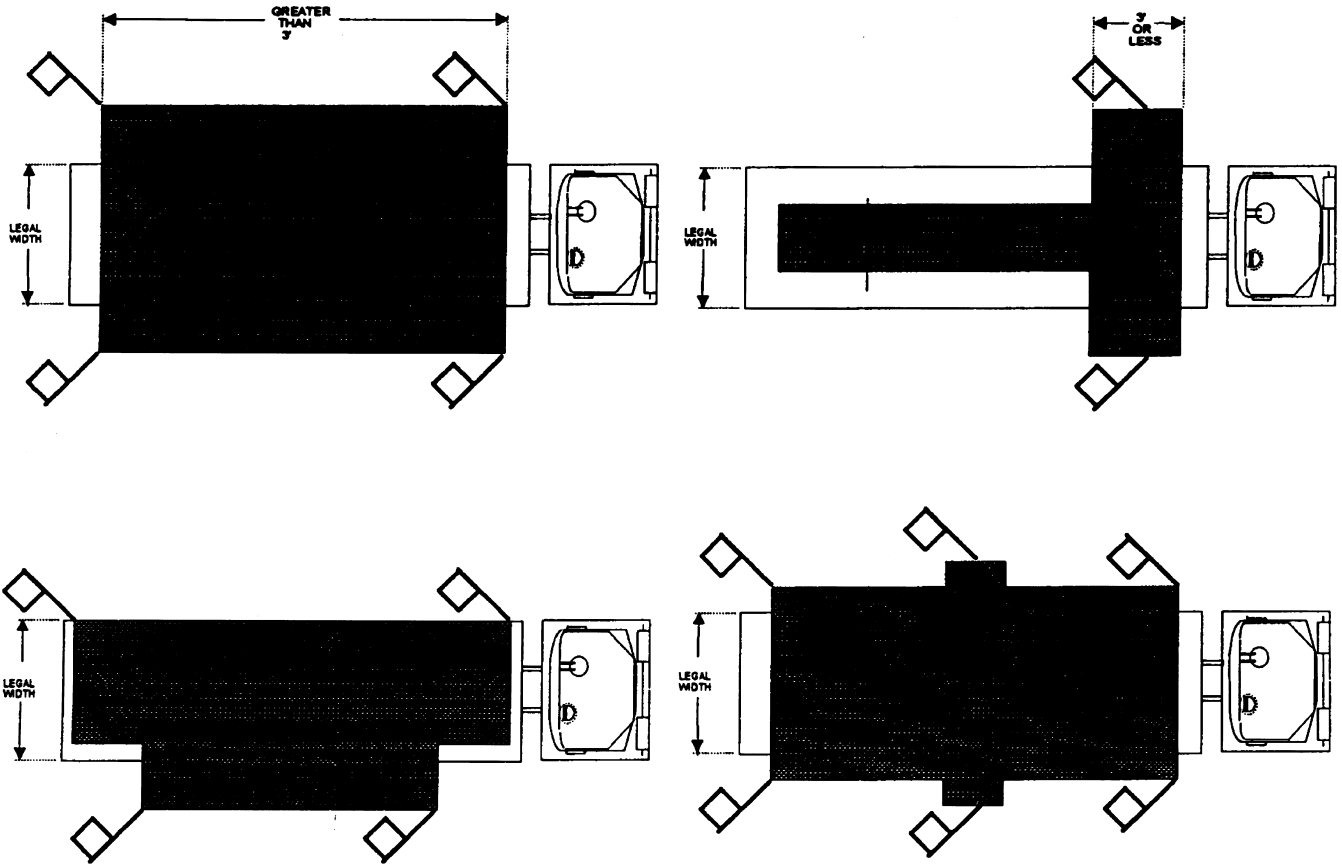

Figure C-1 Required Warning Flags on Overwidth Loads.  
Note: Use of flags is not to increase the overall load width.

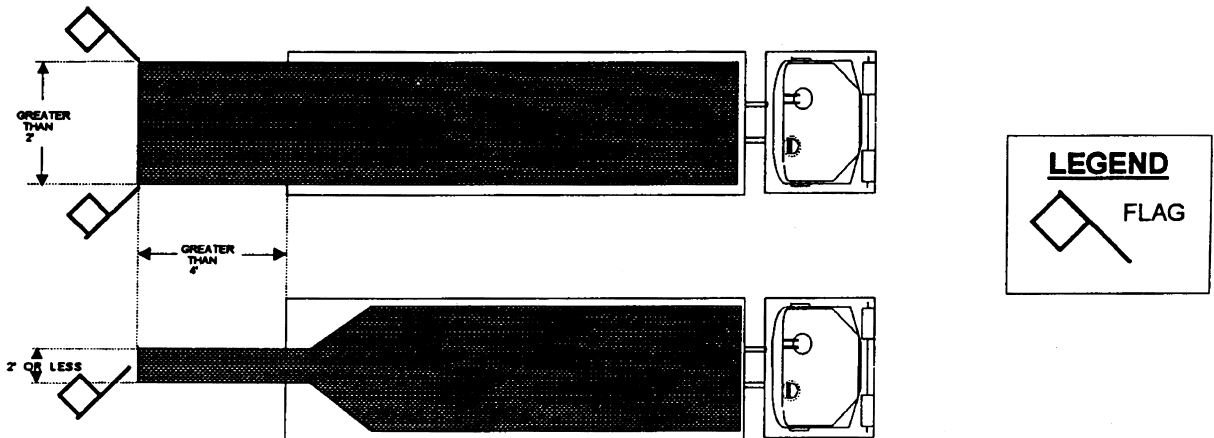

Figure C-2 Required Warning Flags on Overlength Load or Loads with a Rear End Overhang of more than four(4) feet.  
Note: Use of flags is not to increase the overall load width.

**APPENDIX C**  
**Common Safety Standards for Permit Move**

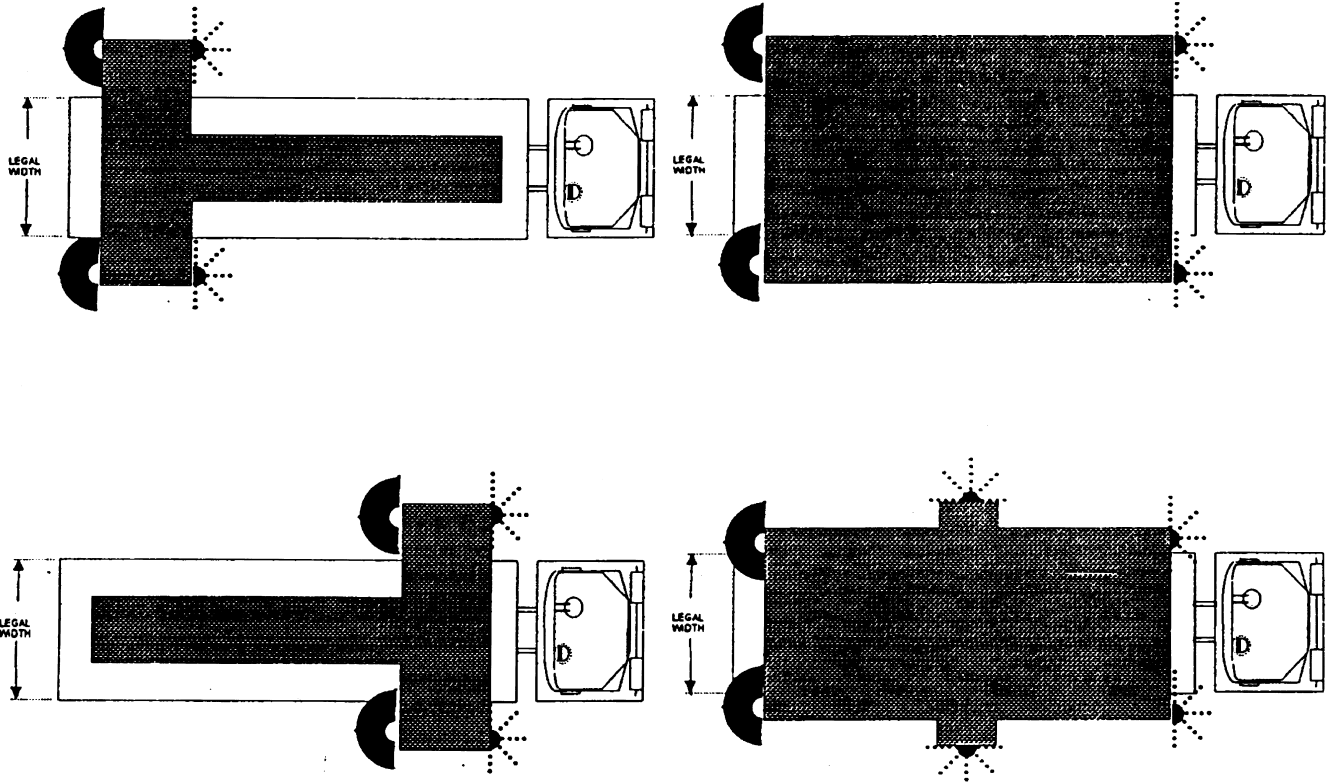

Figure C-3 Required Warning Lights on Overwidth Loads.

NOTE: Amber reflectors or amber lights are required at least every 6 feet along both sides of the overwidth portion of the vehicle or load.

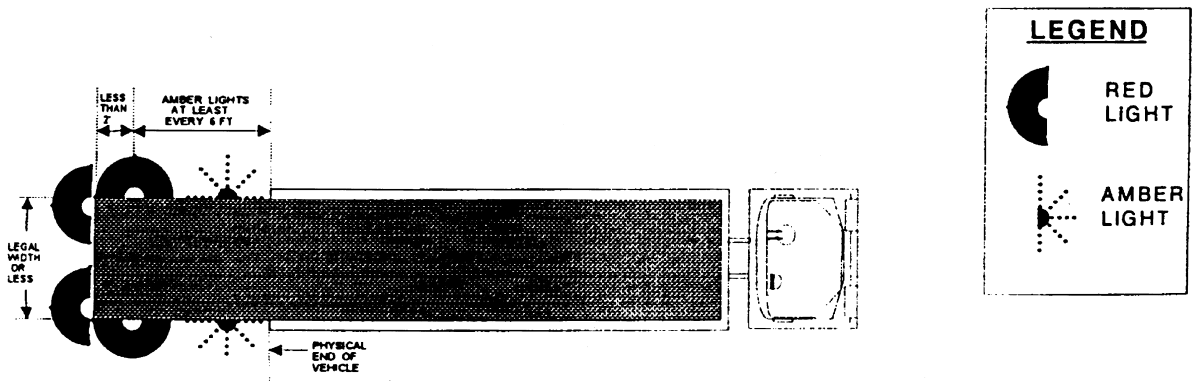

Figure C-4 Required Warning Lights on Overlength Load or Loads with a Rear End Overhang of more than four(4) feet

# APPENDIX C

## Common Safety Standards for Permit Move

---

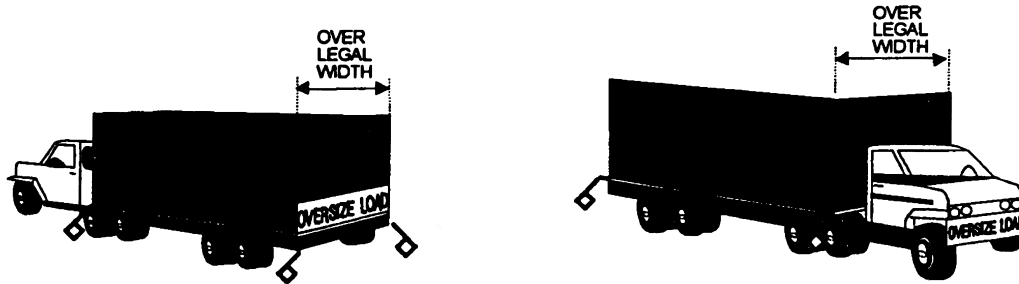

Figure C-5 Warning Signs on Vehicle or Load Over Legal Width.

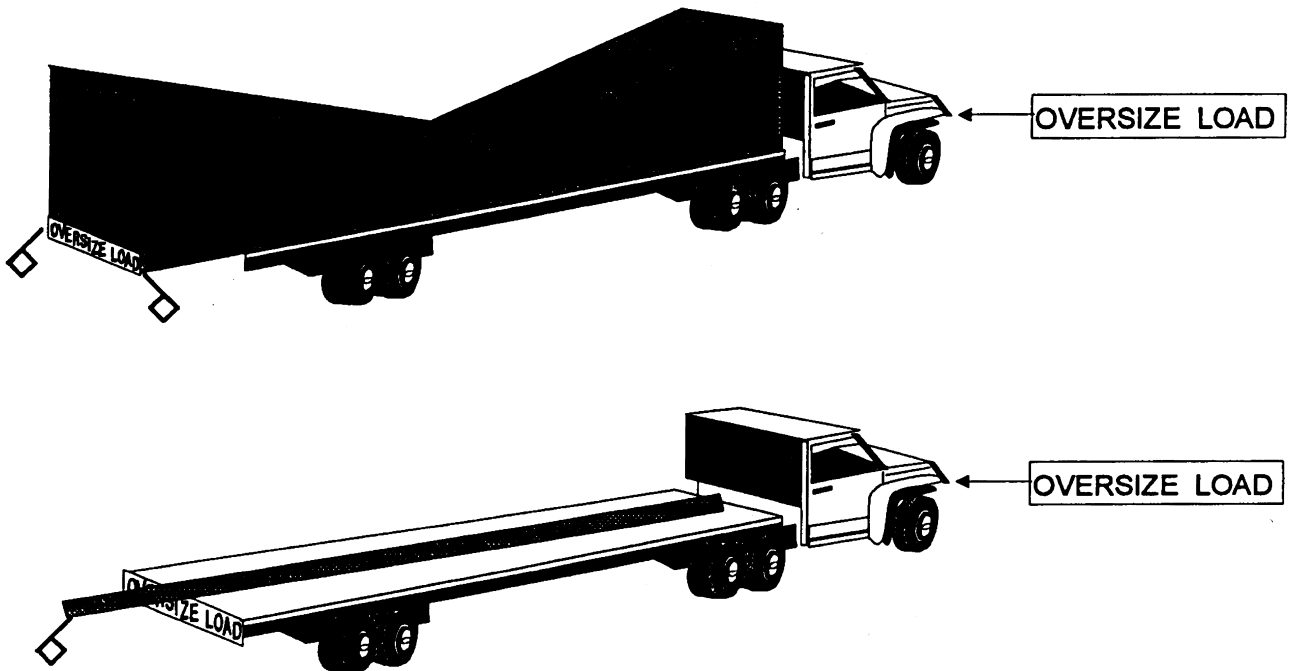

Figure C-6 Warning Signs on Loads Overlength or With Rear End Overhang

## APPENDIX D

## NASTO MULTI-JURISDICTION AGENT AGREEMENT

## D.1 PURPOSE OF THIS AGREEMENT

## D.1.1 Purpose

The purpose of this agreement is to implement an interim regional permitting system for the NASTO region.

## D.1.2 Qualifications

This Agreement only applies to envelope vehicles and loads as described in the NASTO Memorandum of Understanding for Regional Overweight and Over-Dimensional Trip Permits for Vehicles with Nondivisible Loads, APPENDIX A.

## D.1.3 Member Jurisdictions

Member jurisdictions are those jurisdictions that have signed the NASTO Memorandum of Understanding.

## D.2 INTENT

The intent of this Agreement is to ease the burden of obtaining oversize/overweight documents for the trucking industry. Each jurisdiction will continue to do business in the usual manner for all other permit applications.

The Permit Agent (as defined herein) will be the central mechanism for processing a Multi-Jurisdiction oversize/overweight permit under this Agreement.

## D.3 PERMIT AGENT

## D.3.1 Definition

A permit agent (permit service) is defined as any persons, company, corporation or legal entity agreeing in writing to the terms and conditions of this Agreement and assuming responsibility for processing multi-jurisdiction permit requests under the provisions of this Agreement and for compiling permits issued by member jurisdictions for the movement of an oversize/overweight vehicle or load that is consistent with the conditions and specifications of this Agreement, as approved by a governmental entity authorized to issue such permits for that jurisdiction. Such permit agency shall be an independent service agency not affiliated with motor carriers engaged in the movement of oversize/overweight goods and agreeing to and capable of successfully performing the duties of a permit agent as provided for in this Agreement.

## D.3.2 Qualifications

Participating permit agents must be authorized to operate in each member jurisdiction either directly or through third party contracts as provided for under Section I of the NASTO Agent Agreement Form. All permit agents must comply with all contracts with each member jurisdiction.

## D.3.3 Common Permit Form

All Agents must utilize the same NASTO Common Permit Form. A sample of this form is provided in APPENDIX D-2, of this Agreement.

Any changes to be made to the NASTO Common Permit Form will allow for a 60 day written notice to both the states and Permit Agents, to allow the proper lead time for everyone involved to make the adjustments.

## D.3.4 Permit Numbers

All Multi-Jurisdiction permit numbers issued by a Permit Agent will begin with the last digit of the year (digit #1), the month (digits #2 & #3), the day (digits #4 & #5), a 4-digit sequential number to be assigned by the

permit agent (digits #6 - #9), and a unique two-letter code to be assigned to the managing permit agent by the Chair of the NASTO Highway Transport Committee (digits #10 & #11). (Example: 306110001AB).

## D.3.5 Number of Pages Per Form

The current approved NASTO Common Permit Form is a single page document unless designated otherwise on the face of the permit.

## D.3.6 Form Limitation

The NASTO Common Permit Form will be used only to issue permits in accordance with the Multi-Jurisdiction Permit Agreement.

## D.3.7 Permit Amendments

Any change or modification to a permit must be noted on the NASTO Common Permit Amendment Form. A sample NASTO Permit Amendment Form is provided in APPENDIX D-3. Changes allowed include: a three day extension due to weather or breakdown, route change due to physical limitations, substitution of power unit or trailer unit due to breakdown, and power unit and/or trailer unit prior to effective date. Mobile home and other loads where the trailer unit is an integral part of the load, cannot amend the trailing unit.

Amendments to the permit must be issued by the same Permit Agent. The Permit Agent shall follow the same procedures to obtain the amendment by contacting each of the effected jurisdictions. Only one permit amendment is allowed.

## D.3.8 Acceptance of Permit

Upon receipt of the permit, the driver(s) shall be responsible to verify the accuracy of the information and sign each page of the NASTO Common Permit Form.

## D.4 ORDERING METHODS

## D.4.1 Motor Carrier

All Multi-Jurisdiction Agreement permits must be obtained through a qualified Multi-Jurisdiction Permit Agent and it is recommended that permits be ordered with a 24-hour lead-time to coordinate all jurisdictions' responses.

## D.4.2 Permit Agents

All orders must be submitted by the qualified Permit Agent to the appropriate jurisdiction for approval. This request must be identified as a Multi-Jurisdictional Permit Application unless waived.

## D.4.3. Jurisdiction Turnaround Time

The jurisdiction will utilize a goal of turnaround time for approving/denying the permit applications in less than four (4) business hours from time of receipt.

## D.5 DENIED PERMITS

## D.5.1 Notification

Permit applications will be reviewed thoroughly for problems. The permit application will be sent back to the Permit Agent with identified problems.

## D.5.2 Alternate Routing

If an application is received by a jurisdiction and a route cannot be used, alternate routes may be sent back to the Permit Agent applying for the permit.

### D.5.3 Jurisdiction Routing Notification

The jurisdictions will supply, upon request, to the Multi-Jurisdiction Authorized Permit Agent any highway restriction(s) to better control the possible denials to the Agreement permits.

### D.6 AMENDMENTS TO AGREEMENT

All changes made to the Multi-Jurisdiction Agreement will go into effect no earlier than 60 days after approval to allow sufficient amount of time for the authorized Permit Agent to implement the changes.

### D.7 FINANCE ACCOUNTING

#### D.7.1 Payment

The authorized Permit Agent will use each Jurisdiction's current payment method.

#### D.7.2 Changes to Payment Systems

All options for changing a jurisdiction payment system of the Multi-Jurisdiction Agreement will remain open but no changes can be made without a 60-day written notice to all Permit Agents. The 60-day written notice can be modified if agreed to by all affected parties.

### D.8 REPORTS

On a quarterly basis, all authorized Multi-Jurisdiction Permit Agents will supply to each jurisdiction, unless waived, the individual jurisdiction's list of the permits that have been issued under this Agreement for moves within that jurisdiction. This report is to include name of applicant, date issued, applicable jurisdiction permit number, Multi-Jurisdiction Permit Number, and jurisdiction fee charged for the permit. The list shall be in sequential order using the multi-jurisdiction permit number skipping those permits that do not traverse through the reported jurisdiction. The report shall be broken down by month with subtotals for each month and a total for the quarter. A separate summary report shall be provided that shows, by month, the total number of multi-jurisdictional permits that have been issued, and the total number that have been issued for each jurisdiction. The reports shall be based on a calendar year with the reports due fifteen days after the end of the quarter, i.e. reports due April 15, July 15, October 15, and January 15.

### D.9 AUDIT

At any time, a jurisdiction may inspect any permit or permit issuing process involved with the Multi-Jurisdiction Agreement. The jurisdiction should give 24-hour notice before showing up at any Permit Agent's location.

### D.10 IMPLEMENTATION

Before being authorized to participate in the NASTO MULTI-JURISDICTION PERMITTING AGREEMENT process, the Requesting Permit Agent must sign a copy of the Agent Agreement Form, which is APPENDIX D-1 to this document.

### D.11 PROCEDURES FOR ENTERING OR WITHDRAWING FROM THE MULTI-JURISDICTION PERMIT AGENT AGREEMENT

#### D.11.1 Entering Agreement

A Permit Agent applying for membership shall submit their request to the Chair of the NASTO Highway Transport Committee along with a signed NASTO Agent Agreement form, a sample multiple page permit, and sample quarterly reports for the purpose of format approval. The request will be circulated among member jurisdictions who will indicate to the Chair either accep-

tance or rejection of the request with explanation. Upon acceptance of all member jurisdictions, the Chair of the NASTO Highway Transport Committee shall sign and return the Agent Agreement form or indicate rejection within 60 days of receipt of request.

#### D.11.2 Withdrawal by Agent

A Permit Agent may withdraw from the Agreement by giving at least 30 days written notice to the Chair of the NASTO Highway Transport Committee.

#### D.11.3 Withdrawal by NASTO

The member jurisdictions, through the Chair of the NASTO Highway Transport Committee, reserve the right to cancel the Agreement at any time for any reason upon giving thirty (30) days written notice to the Permit Agent of the intent to cancel. Member jurisdictions, through the Chair of the NASTO Highway Transport Committee, reserve the right to immediately cancel without notice, for good cause.

## APPENDIX D-1

### NASTO

### AGENT AGREEMENT FORM

This Agreement is entered into between signatory member jurisdictions of the NASTO Memorandum of Understanding for Regional Overweight and Over-Dimensional Trip Permits for Vehicles with Nondivisible Loads (and its successor organization(s) and \_\_\_\_\_ for the sole purpose of processing multi-jurisdiction oversize/overweight permits authorized under the NASTO MULTI-JURISDICTION PERMITTING AGREEMENT hereinafter known as the "Agreement".

#### WITNESS THAT:

WHEREAS, the member jurisdictions of the Agreement may authorize permit agents to process multi-jurisdiction permits, and

WHEREAS, the member jurisdictions of the Agreement and the Permit Agent wish to enter into a written agreement which will establish the terms and conditions for the issuance of multi-jurisdiction permits,

THEREFORE, in consideration of these facts and of mutual covenant set forth herein, the member jurisdictions of the Agreement and the Permit Agent or Agents named herein mutually agree to the following:

#### SECTION I—Responsibilities

##### A. The Permit Agent shall:

1. Provide for a method to conduct business that is acceptable to each member jurisdiction.
2. Permit Agents with transmitting networks servicing the NASTO region, agree to enter into an written agreement with credible and creditworthy Permit Agent applicants to supply access to their network on a customary and usual transaction fee basis.
3. Maintain a surety bond or escrow account, as required by member jurisdictions, for the entire term of this agreement.
4. Abide by all procedures and policies as provided to Permit Agents by member jurisdictions.
5. Provide a complete transmitting network for the transmitting of permits issued under the provisions of the Agreement or provide legitimate written authority/agreements to utilize the transmitting networks of others.
6. Use the NASTO Common Permit Form identified in Appendix D-2. The information entered onto the form

must be typed or computer generated using a single font. The routing portion of the form shall be filled out sequentially from the origin to the destination for member jurisdictions without skipping any lines. Any blank lines after the last entry shall be filled with asterisks. A maximum of five jurisdictions shall be listed on any one page of the permit. For multiple page permits, each page shall contain identical information with the exception of the routing portion and the page designation.

7. Use the NASTO Common Permit Amendment Form identified in Appendix D-3 when applicable.

B. Member Jurisdiction shall:

1. Initially, and upon request, provide the Permit Agent with information necessary to comply with the regulations of the member jurisdiction.

2. Allow only those Permit Agents to process multi-jurisdiction permits under the Agreement that have their own transmitting networks or that have legitimate written authority/agreements to utilize the transmitting networks of others.

SECTION II—Duration

This Agreement shall be in full force effective the date signed by the Chair of the NASTO Highway Transport Committee until such time as cancelled as provided for under Section III.

SECTION III—Cancellation

Member jurisdictions and the Permit Agent each reserve the right to cancel this Agreement at any time for any reason upon giving thirty (30) days written notice to the other party(s) of the intent to cancel. Member jurisdictions reserve the right to immediately cancel without notice, for good cause.

SECTION IV—Amendments

All changes in the terms or conditions of this agreement shall be made in writing.

SECTION V—Laws

The laws of member jurisdictions shall govern the interpretation, validity, and effect of this Agreement within the member jurisdiction.

SECTION VI—General

The Permit Agent herein named and the member jurisdictions acknowledge that they have read this Agreement and its attachment(s) and understand it and agree to be bound by its terms and further agree that it is the complete and exclusive statement of the Agreement.

In witness whereof, the parties hereby have duly executed the Agreement by their proper offices and representatives.

PERMIT AGENT:

\_\_\_\_\_

COMPANY NAME

BY:

\_\_\_\_\_

SIGNATURE OF AUTHORIZED OFFICER

\_\_\_\_\_

PRINTED NAME AND TITLE

\_\_\_\_\_

DATE

NASTO:

\_\_\_\_\_

CHAIR, NASTO HIGHWAY TRANSPORT COMMITTEE

\_\_\_\_\_

DATE

# NORTHEAST MULTI-JURISDICTIONAL PERMIT OVERSIZE/OVERWEIGHT NONDIVISIBLE LOADS

APPENDIX D-2 11/98

PAGE \_\_\_ OF \_\_\_

PERMIT AGENT		REQUESTED START DATE				SEND PERMIT TO:			OVERALL LENGTH	FEET	INCHES*	OVERALL HEIGHT	FEET	INCHES*
LOAD DESCRIPTION - MAKE, MODEL, SERIAL No., OR BILL OF LADING No.						LOAD CODE			WIDTH			OVERHANG FEET FRONT REAR		
MOTOR CARRIER'S NAME AND ADDRESS						USDOT / FEIN / SS #								
						VEHICLE	LIC. PLATE # IF NONE : VIN		ST/ JUR	# OF AXLES	REGISTERED GW			
						POWER UNIT					LBS.			
						TRAILER					LBS.			
AXLE #	STEERING AXLE	2	3	4	5	6	7	GROSS WEIGHT						
AXLE WEIGHTS								LBS.						
AXLE SPACINGS FEET/INCHES"		' "		' "		' "		' "		' "				
SPECIFIC ADDRESS OF TRIP ORIGIN						SPECIFIC ADDRESS OF TRIP DESTINATION								
VIA JURISDICTION	ROUTING INFORMATION						TRIP LENGTH IN MILES	APPROVAL #	FEES OFFICIAL USE ONLY					
<p>(WE) HAVE READ THIS FORM AND HEREBY CERTIFY: THAT THE ABOVE DATA IS CORRECT TO THE BEST OF MY(OUR) KNOWLEDGE AND BELIEF, THAT THE LOAD IS NONDIVISIBLE, THAT SATISFACTORY ARRANGEMENTS HAVE BEEN MADE WITH THE PROPER AUTHORITIES TO TRAVEL ROADS AND CROSS OVER AND UNDER ALL STRUCTURES OPERATED BY AUTHORITIES NOT PARTY TO THIS MULTI-JURISDICTIONAL PERMIT. APPLICANT'S REPRESENTATIVE CERTIFIES THAT THE DRIVER WILL BE PROVIDED WITH A COPY OF APPENDIX C. THE DRIVER(S) CERTIFY(IES) RECEIPT OF A COPY OF APPENDIX C.</p>														
NAME OF APPLICANT'S REPRESENTATIVE						REP'S PHONE NUMBER			DRIVER SIGNATURE					
DATE & TIME OF APPLICATION						REP'S FAX NUMBER			DRIVER SIGNATURE					
<b>OFFICIAL USE ONLY</b>														
EFFECTIVE DATE :						ISSUE DATE :								
EXPIRATION DATE :						ISSUE TIME :			PERMIT NUMBER :					
SPECIAL PROVISIONS:														
NUMBER OF ESCORTS REQUIRED: _____														
<p>THE SIGNED PERMIT MUST BE WITH THE VEHICLE DURING THE MOVE. AUTHORIZATION AND PERMISSION IS HEREBY GRANTED TO MOVE THE VEHICLE/LOAD ON THE ROUTING AS DESCRIBED ABOVE. THIS MOVEMENT SHALL ALSO BE MADE IN COMPLIANCE WITH THE PROVISIONS LISTED IN APPENDIX C. THIS PERMIT MAY BE CONFISCATED AND/OR INVALIDATED IF ANY LAWS, RULES, REGULATIONS, OR PROVISIONS OF A MEMBER JURISDICTION AND/OR THE NASTO REGIONAL PERMITTING AGREEMENT ARE VIOLATED. ALL POSTED HIGHWAY/BRIDGE LIMITS MUST BE OBSERVED UNLESS SPECIFICALLY EXEMPTED HEREIN.</p>														

APPENDIX D-3

NASTO MULTI-JURISDICTION PERMIT

AMENDMENT FORM

This form will amend the referenced permit and must be attached and carried with the vehicle at all times for inspection by appropriate authorities. Any other changes to the permit that are not covered by this official form will nullify/void it for further use under the NASTO Multi-jurisdiction Permit Agreement and a separate permit must be obtained for any continued movement.

AMENDMENT

Effective Date: \_\_\_\_\_ Multi-Jurisdiction Permit Number \_\_\_\_\_

Extension Expiration Date: \_\_\_\_\_

Jurisdiction	Original Permit #	Amendment #	Jurisdiction Amendment Fees
_____	_____	_____	_____
_____	_____	_____	_____
_____	_____	_____	_____
_____	_____	_____	_____
_____	_____	_____	_____

Motor Carrier: \_\_\_\_\_

Power Unit Lic. #: \_\_\_\_\_

Trailer Unit Lic. #: \_\_\_\_\_

Requested Reason for Amendment

\_\_\_\_\_ Extension of time—weather \_\_\_\_\_ Extension of time—Breakdown

\_\_\_\_\_ Substitution of equipment due to breakdown \_\_\_\_\_ Substitution of equipment prior to effective date

\_\_\_\_\_ Other \_\_\_\_\_

\_\_\_\_\_ Route change due to physical limitations

Jurisdiction	Route Changes
_____	_____
_____	_____
_____	_____

Special Provisions—Official Use Only

Authorized by: \_\_\_\_\_  
Authorized Permit Agent

Driver Acceptance: \_\_\_\_\_  
Driver's Signature



ATTEST:

COMMONWEALTH OF PENNSYLVANIA  
DEPARTMENT OF TRANSPORTATION

Susan H. Roebuck  
Signature DATE

Gravelly M. Leary 5/14/97  
Secretary of DATE  
Transportation

Secretary  
Title  
(SEAL)

ATTEST:

Helen F. Kuen 5/13/97  
Signature DATE  
Exec. Sec.  
Title  
(SEAL)

M. M. Ryan 5/13/97  
Deputy Secretary DATE  
for Highway Administration

APPROVED AS TO LEGALITY  
AND FORM

Michael H. Albine  
for Chief Counsel DATE 5/14/97 Office of General Counsel DATE  
5-14-97

Approved for Form  
and Legality

JUN 18 1997

Blair R. Gull  
Deputy General Counsel

RECORDED NO. 464103  
CERTIFIED FUNDS AVAILABLE UNDER  
ACTIVITY PROGRAM  
SYMBOL  
AMOUNT

BY David C. Boone 7/2/97  
Signature DATE  
for ASSISTANT COMPTROLLER  
Title

APPROVED FOR:  
OFFICE OF THE BUDGET

[Signature] 7/2/97  
Comptroller DATE

PRELIMINARILY APPROVED

BY Joanne L. Subard 5-13-97  
Assistant Counsel

### Notice to all Consultants; Anticipated Consultants Solicitations

The Department of Transportation anticipates soliciting Letters of Interest from Consultant firms interested in providing work and services for the following specific project agreements or open-end contracts between the date of this advertisement and December 31, 1999:

#### Engineering District 2-0

1. S. R. 0219, Section C09  
McKean County  
Preliminary and Final Design
2. S. R. 6220, Section B12  
Centre County  
Construction Inspection  
I-99
3. S. R. 6220, Section A12  
Centre County  
Construction Inspection  
I-99
4. S. R. 6220, Section C12  
Centre County  
Construction Inspection  
I-99
5. S. R. 6220, Section E10  
Centre County  
Construction Inspection  
I-99
6. S. R. 6220, Section C10  
Centre County  
Construction Inspection  
I-99
7. S. R. 6220, Section A10  
Centre County  
Construction Inspection  
I-99
8. S. R. 6220, Section C11  
Centre County  
Construction Inspection  
I-99
9. S. R. 6220, Section A11  
Centre County  
Construction Inspection  
I-99
10. S. R. 0080, Section B21  
Clinton County  
Construction Inspection  
Lamar Inter.
11. S. R. 0022, Section C02  
Mifflin County  
Construction Inspection  
Lewistown Bypass
12. S. R. 0022, Section A02  
Mifflin County  
Construction Inspection  
Lewistown Bypass

#### Engineering District 3-0

1. S. R. 0015, Section C41  
Lycoming County  
Preliminary Engineering and  
Final Design

2. S. R. 0220, Section 075  
Lycoming County  
Preliminary Engineering
3. S. R. 0405, Section 063  
Lycoming County  
Preliminary Engineering and  
Final Design
4. S. R. 0061, Section 079  
Northumberland County  
Preliminary Engineering and  
Environmental Studies

#### Engineering District 4-0

1. S. R. 0029, Section 770  
Wyoming County  
Bridge Replacement  
Preliminary Engineering and  
Final Design
2. S. R. 2001, Sections 401 and 402  
Pike County  
Highway Rehabilitation  
Preliminary Engineering and  
Final Design
3. S. R. 0434, Section 470  
Pike County  
Bridge Replacement  
Preliminary Engineering and  
Final Design
4. S. R. Souci, Section 000  
(LCCC Connector Road)  
Luzerne County  
New Highway on New Location  
Preliminary Engineering and  
Final Design
5. Four (4) Open-End Contracts  
Engineering and Environmental Services
6. One (1) Open-End Contract  
Cultural Resources Services

#### Engineering District 5-0

1. S. R. 0061, Section 15S  
Berks County  
Safety and Betterment Upgrade  
Preliminary Engineering and  
Final Design
2. S. R. 0183/3055, Section 05S  
Berks County  
Reconstruction of Interchange  
Preliminary Engineering and  
Final Design
3. S. R. 006, Section 014  
Berks County  
Feasibility Study for Safety Improvement
4. S. R. 0222, Section 021  
Berks County  
Feasibility Study for Safety Improvement
5. S. R. 0611, Section 095  
6 Points Intersection  
Monroe County  
Upgrade/Relocation of Intersection  
Preliminary Engineering and  
Final Design
6. S. R. 1018, Section 02B  
Messinger Street Bridge  
Northampton County

Bridge carrying S. R. 1016  
Preliminary Engineering and  
Final Design

7. S. R. 422 Corridor Improvements  
Berks County  
Construction of Safety Improvements  
Preliminary Engineering and  
Final Design
8. S. R. 0080, Section R18  
Carbon County  
Rest Area and Weigh Station  
Construction Inspection
9. S. R. 0078, Section 07M  
Berks County  
Reconstruction of Interstate 78  
Construction Inspection
10. S. R. 0987, Sections 001 and 002  
Lehigh County  
Widening, Relocation, and Rehabilitating of  
Race Street, Airport Road to Schoenersville Road  
Construction Inspection
11. S. R. 0033, Section 001  
Northampton County  
New Construction of S.R. 0033, including the bridge  
over the Lehigh River  
Construction Inspection
12. S. R. 0412, Section DLY  
Northampton County  
4th Street and Daly Avenue Bridge Replacement  
Construction Inspection
13. S. R. 0061, Section 13S  
Schuylkill County  
Pottsville Safety Rehabilitation of S. R. 0061  
Construction Inspection

#### Engineering District 6-0

1. S. R. 0001, Section H05  
Delaware County  
Construction Inspection
2. S. R. 0095, Section FUN  
Delaware and Philadelphia Counties  
Construction Inspection
3. S. R. 0095, Section CON  
Delaware and Philadelphia Counties  
Construction Inspection
4. S. R. 0095, Section NW2  
Delaware County  
Construction Inspection
5. S. R. 0001, Section NW1  
Delaware County  
Construction Inspection
6. S. R. 0095, Section RS2  
Philadelphia County  
Construction Inspection
7. S. R. 0202, Section 300  
Chester County  
Preliminary Engineering and  
Final Design
8. S. R. 0202, Section 610  
Montgomery County  
Preliminary Engineering and  
Final Design
9. S. R. 0476, Section PM7  
Montgomery County

Environmental Studies,  
Preliminary Engineering and  
Final Design

10. S. R. 0095, Section BR1  
Philadelphia County  
Environmental Studies,  
Preliminary Engineering and  
Final Design
  11. S. R. 0095, Section BS1  
Philadelphia County  
Environmental Studies,  
Preliminary Engineering and  
Final Design
  12. S. R. 0095, Section AFC  
Philadelphia County  
Environmental Studies,  
Preliminary Engineering and  
Final Design
  13. S. R. 0113, Section 08B  
Chester County  
Environmental Studies,  
Preliminary Engineering and  
Final Design
  14. S. R. 0202, Section 83S  
Delaware County  
Environmental Studies,  
Preliminary Engineering and  
Final Design
- #### Engineering District 8-0
1. S. R. 0015, Section 006  
Cumberland County  
U. S. 15 Highland Park/Shiremanstown  
Interchange and U. S. 15 PA 581 Interchange  
Interchange Reconstruction  
Environmental, Preliminary Design and  
Final Design  
Multi-Phase Agreement  
Project Manager: Bill Greene (717) 783-5148
  2. S. R. 0022, Section 010  
Dauphin County  
S. R. 0022, Section 004  
Lebanon County  
Safety Improvements  
Blue Ribbon Avenue in Dauphin County to I-78  
in Lebanon County  
Environmental, Preliminary Design and  
Final Design  
Multi-Phase Agreement  
Project Manager: Bill Greene (717) 783-5148
  3. S. R. 2006, Section 001  
Lancaster County  
Pine Grove Bridge  
Covered Bridge over the Octorara Creek  
Bridge Rehabilitation or Replacement  
Preliminary Engineering and  
Final Design  
Multi-Phase Agreement  
Project Manager: Bill Greene (717) 783-5148
  4. S. R. 0081, Section 023  
Lebanon County  
Interstate 81 Reconstruction  
Roadway and Bridge Reconstruction and  
Rehabilitation  
No Right-of-Way anticipated  
CEE with minimal environmental issues  
anticipated

- Preliminary Engineering and Final Design  
Possible Lump Sum Agreement  
Project Manager: John Bachman (717) 783-4519
5. S. R. 3005  
Perry County  
Shermans Creek Bridge 2  
Over Shermans Creek  
Southwest Madison Township  
S. R. 3008  
Adairs, Cisna Mill Bridge  
Over Shermans Creek  
Southwest Madison Township  
S. R. 4001  
Saville Bridge  
Over Buffalo Creek  
Saville Township  
Replacement or Rehabilitation of Three (3)  
Covered Bridges  
Environmental, Preliminary Design and Final Design  
Multi-Phase Agreement  
Project Manager: Divyang Pathak (717) 787-7883
  6. S. R. 0015  
York County  
US 15 Corridor Study  
Dillsburg Area  
Study  
Preliminary Engineering and Final Design  
Multi-Phase Agreement  
Project Manager: Rich Deen (717) 787-5596
  7. S. R. 0074  
York County  
Corridor Improvements  
Red Lion Borough to Maryland State Line  
Environmental, Preliminary Design and Final Design  
Multi-Phase Agreement  
Project Manager: Divyang Pathak (717) 787-7883
  8. S. R. 0083  
York County  
I-83 Exits 7 & 8  
Interchange Improvements  
Study, Environmental, Preliminary Design and Final Design  
Multi-Phase Agreement  
Project Manager: Doug Murphy (717) 783-3752
  9. S. R. 0295, Section 001  
York County  
Susquehanna Trail Bridge  
Bridge Replacement over Big Conewago Creek  
Newberry and Conewago Townships  
Preliminary Engineering and Final Design  
Project Manager: Bill Greene (717) 783-5148
  10. District-wide  
Highway Occupancy Permit Reviews  
Preliminary Engineering and Final Design  
Task Specific Agreement  
Agreement Manager: Glenn Rowe (717) 783-3981
  11. District-wide  
Design Open-End Agreement  
Environmental, Preliminary Design, Final Design, Construction Consultation and Design Management  
Agreement Manager: Greg Vaughn (717) 783-5149
- Engineering District 10-0
1. S. R. 0356, Section 250  
Butler County  
Final Design  
Wayne Street Bridge  
Estimated Construction Cost \$13 Million
  2. S. R. 3025, Section 230  
Butler County  
Preliminary Engineering, Environmental Studies, Final Design and Construction Consultation  
Seneca Missing Ramps  
Estimated Construction Cost \$18 Million
  3. S. R. 0228, Section 290  
Butler County  
Preliminary Engineering, Environmental Studies and Environmental Impact Statement  
Criders Corners East
  4. S. R. 0830, Section 590  
Jefferson County  
Preliminary Engineering, Environmental Studies and Environmental Impact Statement  
Airport Access Road
  5. S. R. 0080, Section 545  
Preliminary Engineering, Environmental Studies, Final Design and Construction Consultation  
I-80/36 Interchange  
Estimated Construction Cost \$5 Million
  6. S. R. 0080, Section 552  
Butler, Clarion, and Jefferson Counties  
Feasibility Study  
High-Level Bridge Widening Study
  7. S. R. 0022, Section 495  
Indiana County  
Final Design  
Gas Center  
Estimated Construction Cost \$28 Million
  8. Open-End  
Design Review
  9. Open-End  
Construction Inspection
- Engineering District 11-0
1. S. R. 4003, Section A09  
Construction Inspection
  2. S. R. 4003, Section A10  
Construction Inspection
  3. S. R. 3026, Section A02  
Construction Inspection
  4. S. R. 0130, Section A07  
Construction Inspection
  5. S. R. 2004, Section B05  
Construction Inspection
  6. S. R. 2004, Section 006  
Construction Inspection
- Engineering District 12-0
1. S. R. 0021, Section A10  
Fayette County

Preliminary Design  
Estimated Construction Cost \$30 Million

2. S. R. 0022, Section B08  
Westmoreland County  
Final Design  
Estimated Construction Cost \$18 Million

This advance notification is being provided by the Department of Transportation to allow the Consultants to begin building their team prior to the actual advertisement in the *Pennsylvania Bulletin*. The response time to submit a letter of interest on the above projects/open-end contracts will be six (6) calendar days.

Letters of Interest are not requested at this time. Specific advertisements will appear in future issues of the *Pennsylvania Bulletin*.

BRADLEY L. MALLORY,  
*Secretary*

[Pa.B. Doc. No. 99-1062. Filed for public inspection July 2, 1999, 9:00 a.m.]

### Retention of Engineering Firms

#### **Bedford, Blair, Cambria, Fulton, Huntingdon and Somerset Counties Project Reference No. 08430AG2371**

The Department will retain an engineering firm for a specific project contract to perform NBIS bridge safety inspections for designated bridges on the state system throughout Engineering District 9-0, that is Bedford, Blair, Cambria, Fulton, Huntingdon and Somerset Counties. This contract will be for a period of two (2) years from November 1, 1999 to October 31, 2001.

The selected firm will be required to inspect/reinspect state owned bridges at various locations and provide updated inspection reports including a bridge load capacity rating/rerating as warranted; furnish bridge inventory and appraisal data and completed BMS coding sheets; and to provide inventory and operating ratings based on existing conditions for H, HS, and ML 80 loading using the Department's computer programs where applicable.

The Department will establish an order of ranking of a minimum of three (3) firms for the purpose of negotiating an Engineering Agreement based on the Department's evaluation of the acceptable letters of interest received in response to this solicitation. The ranking will be established directly from the letters of interest. Technical proposals will not be requested prior to the establishment of the ranking.

The following factors, listed in order of importance, will be considered by the Department during the evaluation of the firm submitting letters of interest:

- a. Review of inspector's resumes with emphasis on bridge inspection capabilities.
- b. Understanding of Department's requirements, policies, and specifications.
- c. Number of NBIS certified bridge inspectors.
- d. Past Performance.

The qualifications and experience required of the firm's inspectors will be established by the Department, and the qualifications of the firm's proposed employees will be reviewed and approved by the Department.

This project reference assignment is considered non-complex. The letter of interest shall be limited to a maximum of three (3) pages, 8 1/2" x 11", one sided, plus an organizational chart (up to 11" x 17" size), and additional resumes, if applicable. (See the General Requirements and Information Section for additional requirements for the Letter of Interest).

The Letter of Interest submission shall be sent to:

Mr. Earl L. Neiderhiser, P.E., District Engineer  
Engineering District 9-0  
1620 N. Juniata Street  
Hollidaysburg, PA 16648

The Letter of Interest submission for this project reference number must be received at the address listed above by 4:30 P.M. prevailing time on the twentieth (20th) day following the date of this Notice.

Any technical questions concerning the requirements for this project should be directed to: Mr. David L. Sherman, P.E., District 9-0, at (814) 696-7172.

### General Requirements and Information

Firms interested in providing the above work and services are invited to submit a Letter of Interest with the required information for each Project Reference Number for which the applicant wishes to be considered.

The Letter of Interest and required information must be submitted to the person designated in the individual advertisement.

The Letter of Interest and required information must be received by the Deadline indicated in the individual advertisement.

All consultants, both prime consultants and subconsultants, who desire to be included in a Letter of Interest must have an Annual Qualification Package on file with the appropriate District Office, by the deadline stipulated in the individual advertisements.

For Statewide projects, all consultants, both prime consultants and subconsultants, who desire to be included in a Letter of Interest must have an Annual Qualification Package on file with the Central Office, Bureau of Design by the deadline stipulated in the individual advertisements.

By submitting a letter of interest for the projects that requests engineering services, the consulting firm is certifying that the firm is qualified to perform engineering services in accordance with the laws of the Commonwealth of Pennsylvania.

Information concerning the Annual Qualification Package can be found in Strike-off Letter No. 433-99-04 or under the Notice to all Consultants published in the February 27, 1999 issue of the *Pennsylvania Bulletin*.

The requirements for Letters of Interest, in addition to the requirements stipulated in the individual advertisement, are as follows:

1. The Letter of Interest must include the project reference number, the firm's legal name, and the firm's federal identification number.
2. Identify the project manager.
3. Identify subconsultants, if any, including DBE/WBE, if required.
4. Identify key project staff.

If a Joint Venture responds to a project advertisement, the Department of Transportation will not accept sepa-

rate Letters of Interest from the Joint Venture constituents. A firm will not be permitted to submit a Letter of Interest on more than one (1) Joint Venture for the same Project Reference Number. Also a firm that responds to a project as a prime may not be included as a designated subcontractor to another firm that responds as a prime to the project. Multiple responses under any of the foregoing situations will cause the rejection of all responses of the firm or firms involved. The above does not preclude a firm from being set forth as a designated subcontractor to more than one (1) prime responding to the project advertisement.

If a goal for Disadvantaged Business Enterprise (DBE) participation is established for an advertised project, firms expressing interest in the project must agree to ensure that Disadvantaged Business Enterprise (DBE) firms as defined in the Transportation Equity Act for the 21st century (TEA-21) and currently certified by the Department of Transportation shall have the maximum opportunity to participate in any subcontracting or furnishing supplies or services approved under Form 442, Section 1.10(a). The TEA-21 requires that firms owned and controlled by women (WBEs) be included, as a presumptive group, within the definition of Disadvantaged Business Enterprise (DBE). The goal for DBE participation shall be as stated in the individual project advertisement. Responding firms shall make good faith

efforts to meet the DBE goal using DBEs (as they are defined prior to the act, WBEs or combinations thereof).

Proposing DBE firms must be certified at the time of submission of the Letter of Interest. If the selected firm fails to meet the established DBE participation goal, it shall be required to demonstrate its good faith efforts to attain the goal.

Responses are encouraged by small firms, Disadvantaged Business Enterprise (DBE) firms, and other firms who have not previously performed work for the Department of Transportation.

The assignment of the agreement/contract for the above advertisement(s) will be made to one of the firms who submitted an acceptable Letter of Interest in response to the project advertisement. The assignment will be made based on the Department's evaluation of the firm's qualification and capabilities. The Department reserves the right to reject all letters submitted, to cancel the solicitations requested under this Notice, and/or to readvertise solicitation for the work and services.

BRADLEY L. MALLORY,  
*Secretary*

[Pa.B. Doc. No. 99-1063. Filed for public inspection July 2, 1999, 9:00 a.m.]

## GOVERNOR'S OFFICE

### Regulatory Review

Executive Order 1996-1, which was signed by Governor Ridge on February 6, 1996, requires all agencies under the jurisdiction of the Governor to submit for publication an agenda of regulations under development or consideration. The following is the seventh publication of the Administration's regulatory agenda, grouped by agency. Subsequent agendas will be published on the first Saturdays in February and July.

The agendas are compiled to provide members of the regulated community advanced notice of regulatory activity. It is the intention of the Administration that these agendas will serve to increase public participation in the regulatory process.

Agency contacts should be contacted for more information regarding the regulation and the procedure for submitting comments.

This Agenda represents the Administration's present intentions regarding future regulations. The nature and complexity of an individual regulation obviously will determine whether and when any particular regulation listed below (as well as any considered subsequent to publication of this Agenda) is published.

<i>Regulation Being Considered</i>	<i>Proposed Date for Promulgation</i>	<i>Need and Legal Basis for Action</i>	<i>Agency Contact</i>
<b>ADMINISTRATION</b>			
No regulations being developed or considered at this date.			
<b>AGING</b>			
PA Code Title VI Chapter 11 Older Adult Daily Living Centers	July 2000, as proposed.	This regulation will, as part of the Cross-System Licensing Project, be consolidated with regulations from DPW and DOH and published as part of regulations to be proposed as Adolescent and Adult Day Center Licensing Regulations. Review is also occurring as a result of passage of Acts 169-96 and 13-97 and of Executive Order 1996-1.	Robert Hussar 717-783-6207

<i>Regulation Being Considered</i>	<i>Proposed Date for Promulgation</i>	<i>Need and Legal Basis for Action</i>	<i>Agency Contact</i>
PA Code Title VI Chapter 15 Protective Services For Older Adults	November 1999, as proposed.	Proposed amendments have been drafted by the Department and approved by the Budget Office and the Policy Office and are currently under review by the Office of General Counsel. This regulation is being reviewed as a result of passage of Acts 169-96 and 13-97 and of Executive Order 1996-1; the Department will make a report to the General Assembly on this topic by June 30, 1999, as required by law.	Robert Hussar 717-783-6207
PA Code Title VI Chapter 21 Domiciliary Care Services for Adults	July 2000, as proposed.	Review is occurring as a part of a Departmental evaluation and updating process for this community-based living arrangement.	Robert Hussar 717-783-6207
PA Code Title VI Chapter 3 Fair Hearings and Appeals	July 2000, as proposed.	This regulation has been initially reviewed by stakeholders in response to passage of Acts 169-96 and 13-97 and as a result of Executive Order 1996-1.	Robert Hussar 717-783-6207
<b>AGRICULTURE</b>			
Agricultural Land Conservation Assistance Grant Program 7 Pa. Code Chapter 138h	July, 1999, as proposed.	This regulation will amend current regulations to refine the criteria pursuant to which the Department awards grants for farmland protection projects of Statewide scope. The draft proposed regulation is currently under review at the Office of General Counsel.	Raymond Pickering (717) 783-3167
"Clean and Green" Regulations 7 Pa. Code Chapter 137	January, 2000, as proposed. No later than April 30, 2001, as final.	Act 156 of 1998 revised the "Clean and Green" Law (72 P. S. §§ 5490.1-5490.13) and afforded the Department until April 30, 2001 by which to promulgate regulations to implement these revisions. The regulations will promote uniform and consistent interpretation and enforcement of the Act Statewide.	Raymond Pickering (717) 783-3167
Agricultural Conservation Easement Purchase Program	September, 1999, as proposed.	Act 138 of 1998 amended the Agricultural Area Security Law by permitting local government unit participation in agricultural conservation easement purchases. The regulations at 7 Pa. Code Chapter 138e must be revised to implement this statutory change.	Raymond Pickering (717) 783-3167
Consolidation/Update of Retail Food Store Regulations	January, 2000, as proposed.	This regulation would provide the retail food industry needed and requested guidance for the safe handling of food. The Food Act (31 P. S. §§ .20.1-20.18) is the statutory basis for this regulation.	Lenchen Radle (717) 772-3234
Food Employee Certification 7 Pa. Code Chapter 83	October, 1999, as final.	This regulation is required by the Food Employee Certification Act (3 Pa.C.S. §§ 6501-6510), and will establish standards for training of certain food industry personnel.	Martha Melton (717) 782-8354
Land application of soil and groundwater contaminated with agricultural chemicals	September, 1999, as proposed.	This regulation is required under the Land Recycling and Environmental Remediation Standards Act, at 35 P. S. § .6026.101 et seq. This regulation would allow soil and groundwater contaminated with agricultural chemicals to be treated and re-applied upon agricultural lands.	Phillip M. Pitzer (717) 772-5206

<i>Regulation Being Considered</i>	<i>Proposed Date for Promulgation</i>	<i>Need and Legal Basis for Action</i>	<i>Agency Contact</i>
Farm Safety and Occupational Health Grant Program	July, 1999, as proposed.	This regulation is needed to replace an existing statement of policy published in the March 16, 1996 Pennsylvania Bulletin. This regulation would formalize the statement of policy by which the Farm Safety and Occupational Health Grant Program operates. The Program awards grants to fund projects to increase the knowledge and awareness of farm safety measures and occupational health issues among the Commonwealth's rural youth.	Phillip M. Pitzer (717)772-5206
Maple Products	July, 2000, as proposed.	This regulation is required by the Maple Products Act (3 Pa.C.S. §§ 6101-6112). This regulation would establish standards, product quality practices and facility requirements relating to the production of maple syrup and maple products.	Lenchen Radle (717) 772-3234
Harness Racing Commission	September, 1999, as proposed.	This regulation is necessary to update current regulations, make them more user-friendly and address conditions which exist in harness racing that did not exist when the current regulations were originally promulgated. This regulation is a long-term project and would amend 58 Pa. Code Chapters 181, 183, 185 and 186-190, including the general authority of the Commission and provisions relating to associations licensed to conduct pari-mutuel wagering, individual licensing, licensing of officials, rules of the conduct of races, veterinary practices, equine health and medication, wagering, due process and disciplinary action.	Jorge Augusto, Esquire (717) 787-8744
Horse Racing Commission	August, 1999, as final.	This regulation will revise several definitions, as well as clarify provisions related to "coupled entries" and trifecta races.	Benjamin H. Nolt, Jr. (717) 787-1942
Sustainable Agriculture Grant and Loan Programs	August, 1999, as final.	This regulation establishes grant and loan programs to implement best management practices. These programs are required under the Sustainable Agriculture Act (3 P. S. §§ 2101-2107).	John Tacosky (717) 772-5217
Fruit Tree Improvement Program	December, 2000, as proposed.	This regulation would facilitate interstate and international export of Pennsylvania-grown fruit tree nursery stock. This regulation would amend 7 Pa. Code Chapter 120, which provides testing and inspection standards and procedures pursuant to which fruit tree nursery stock can be certified as to quality, consistency and disease/insect-free status. The regulation would be a technical update of current provisions, would bring this program into greater conformity with programs in other states and would provide more practical assistance to participating growers.	Ruth Welliver (717) 787-5609



<i>Regulation Being Considered</i>	<i>Proposed Date for Promulgation</i>	<i>Need and Legal Basis for Action</i>	<i>Agency Contact</i>
Certification of Virus-Tested Geraniums	September, 1999, as proposed.	This regulation would amend the current regulatory authority to update the voluntary program pursuant to which geranium producers may obtain the Department's certification of virus-tested geraniums. This amendment would establish an inspection fee to help cover the Department's costs in inspecting and testing geraniums offered for certification. This regulation would amend 7 Pa.Code Chapter 122 to: 1) expand the certification of virus-tested geraniums to include Culture-Indexed Geraniums, which are free from certain economically-important bacterial and fungal pathogens; and 2) establish a fee for the Department's inspection and certification services.	Ruth Welliver (717) 787-5609
Dog Law	July, 1999, as proposed.	House Bill 397 of 1996 accomplished revisions of the Dog Law that will necessitate regulatory revisions. This regulation is a long-term project and would amend 7 Pa. Code Chapters 21,23,25 and 27 to bring them into greater conformity with statutory revisions. The Dog Law (3 P. S. §§ .459-10 et seq.) is the statutory basis for this regulation.	Richard Hess (717) 787-4833
Domestic Animals	October, 1999, as proposed.	This long-term project is intended to update the Department's regulatory authority to make it more consistent with the provisions of the Domestic Animal Law (3 Pa.C.S. §§ 2301-2389).	John Enck, DVM (717) 772-2852
Temporary Guidelines for the Importation and Intrastate Transportation of Cervids and Camelids -Statement of Policy 7 Pa. Code Chapter 3a	September, 1999.	The planned revisions of this chapter will bring its provisions into greater conformity with the requirements of the Domestic Animal Law.	John Enck, DVM (717) 772-2852
Pseudorabies Disease 7 Pa. Code Chapter 10	September, 1999, as proposed.	The planned revisions of this chapter will assist the Department in attaining "Pseudorabies-free" status under the joint Federal-State Industry Pseudorabies Eradication Program, and will bring the current regulation into greater conformity with the requirements of the Domestic Animal Law.	John Enck, DVM (717) 772-2852
Brucellosis Vaccination-Statement of Policy	September, 1999, as proposed.	The planned statement of policy will address advances in vaccination technology, and will ultimately be supplanted by regulations.	John Enck, DVM (717) 772-2852
Aquaculture Development	December, 1999, as proposed.	This regulation will implement the requirements of the recently enacted Aquacultural Development Law.	John Enck, DVM (717) 772-2852

<i>Regulation Being Considered</i>	<i>Proposed Date for Promulgation</i>	<i>Need and Legal Basis for Action</i>	<i>Agency Contact</i>
<b><i>BANKING</i></b>			
Amendments to the Leeway Investments regulations for Pennsylvania state-chartered banking institutions.	December 1999, as proposed.	The existing leeway investments regulations are located at 10 Pa. Code § 27.1 - 27.4 and have been effective since March 9, 1974. These regulations were promulgated pursuant to authority stated in sections 103(a), 307, 311(d)(vi), and 504(b)(x) of the Banking Code of 1965, as amended, 7 P. S. §§ 103(a), 307, 311(d)(vi), and 504(b)(x), and can be amended pursuant to the same statutory authority. Leeway investments are made by Pennsylvania state-chartered banks in stock, bonds, notes, or debentures of corporations formed to promote the public welfare and community development, expand the economy, or provide for social reform. The Department has evaluated the need for additional regulatory guidance in the context of modernizing leeway investment authority for Pennsylvania state-chartered banking institutions, including amending the parameters for Pennsylvania state-chartered banking institutions to make leeway investments.	David H. Bleicken (717) 787-1471
"Other investments" regulations for Pennsylvania state-chartered banking institutions.	December 1999, as proposed.	Sections 103(a) and 315(g) of the Banking Code of 1965, as amended, 7 P. S. §§ 103(a) and 315(g), provide authority for the Department to promulgate regulations to allow Pennsylvania state-chartered banking institutions to make investments not otherwise authorized by the Banking Code. The Department has evaluated the need for such regulatory guidance and authority in the context of modernizing investment authority for Pennsylvania state-chartered banking institutions.	Reginald S. Evans (717) 787-1471
Secondary Mortgage Loan Act regulations.	There is no set date because the Department is evaluating the necessity of such proposed regulations.	The Secondary Mortgage Loan Act ("SMLA"), 7 P. S. § 6601 et seq., was passed in 1980 and most recently amended by Act 15 of 1995. The Department is evaluating the need for regulatory guidance to be provided to second mortgage residential lenders, brokers sponsoring brokers, and broker's agents under the SMLA.	Laurie S. Kennedy, (717) 787-1471
<b><i>BUDGET</i></b>			
No regulations being developed or considered at this date.			
<b><i>COMMUNITY &amp; ECONOMIC DEVELOPMENT</i></b>			
Tax-Exempt Bond Allocation	Fall, 1999, as proposed.	The existing regulation and statement of policy will be rescinded and replaced with new regulations as a result of the passage of Act 100 of 1998, which repealed the act of December 20, 1985 (P. L. 483, No. 113), known as the Tax-Exempt Bond Allocation Act and established new Tax-Exempt Bond Allocation provisions.	Jill B. Busch (717) 720-7314

<i>Regulation Being Considered</i>	<i>Proposed Date for Promulgation</i>	<i>Need and Legal Basis for Action</i>	<i>Agency Contact</i>
Pennsylvania Industrial Development Authority 21 Pa. Code Chapter 37	Fall, 1999, as proposed.	The regulation will delete those portions of the existing regulation of the Pennsylvania Industrial Development Authority Board which ought to be in policies or guidelines rather than in regulation and, if any portion of the regulation remains, it will be brought current to comport with actual administration of the PIDA program.	Gerald W. Kapp (717) 787-6245
Commercial Motion Picture Sales; Tax Exemption Certificate 12 Pa.Code Chapter 33	Fall 1999, as proposed.	The regulation will prescribe a Pennsylvania Exemption Certificate (FORM REV-1220) as the form to be used by producers of commercial motion pictures, who are qualified to take advantage of the PA Sales and Use Tax exclusion provided by Section 204(54) of the Tax Reform Code of 1971.	Jill B. Busch (717) 720-7314
<b>COMMISSION ON CRIME AND DELINQUENCY</b>			
No regulations being developed or considered at this date.			
<b>CONSERVATION &amp; NATURAL RESOURCES</b>			
Conservation of Native Wild Plants	September 1999, as proposed.	This proposal is being developed to update existing native wild plant regulations. The legal basis for these regulations is the Wild Resource Conservation Act of 1982. This update is necessary to change the status of various plants to reflect field work completed during the last three years. Recommendations of the Rare Plant Committee and the Vascular Plant Technical Committee will be considered during the development of this proposed rulemaking.	Daniel A. Devlin (717) 787-3444
State Forest Rules and Regulations	December 2000, as proposed.	This proposal is an update to the State Forest Rules and Regulations which were published in the PA Bulletin December 5, 1998. Due to the controversy and confusion caused by two sections which had been in the proposed rulemaking of the State Forest Rules and Regulations - Section 21.26 (1) Horses and Pack Animals; Section 21.27 (1) Bicycles and Persons - Powered Vehicles, these sections were deleted from the final rulemaking of the State Forest Rules and Regulations in order to address these issues and concerns separately. The Department is currently in consultation with a user work group to redraft these two sections of the regulation.	Michael Palko (717) 783-7941
<b>CORRECTIONS</b>			
Motivational Boot Camp Act 61 P. S. Section 1221 et seq.	July 1999, as final.	The regulations will address boot camp administration, establishment of selection committees, inmate selection criteria, programming and supervision, inmate discipline and staff training.	Victoria S. Freimuth (717) 975-4860
Revisions to the existing regulations governing county correctional facilities, 37 Pa. Code Chapter 95.	July 1999, as final.	The regulation will be revised to eliminate unnecessary regulations and modernize necessary regulations, particularly those affecting the transfer of inmates between state and county correctional facilities.	William M. Reznor (717) 975-4876

<i>Regulation Being Considered</i>	<i>Proposed Date for Promulgation</i>	<i>Need and Legal Basis for Action</i>	<i>Agency Contact</i>
Review and/or revision of all current Department of Corrections regulations contained in Title 37 of the Pennsylvania Code.	Fall 1999, as proposed.	The purpose of the review is to ensure that the Department's regulations are consistent with current legal standards concerning prison administration and operation. The legal basis for the action is found at Section 506 of the Administrative Code of 1929, 71 P. S.186, which grants the Commissioner of Corrections the authority to prescribe regulations for the Department that are not inconsistent with law.	J.D. Shutt (717) 975-4860
<b>EDUCATION</b>			
Pupil Personnel Services Pupil Attendance Students 22 Pa. Code, Chapters 7, 11, 12	The State Board of Education is not considering revisions to these regulations at this time. They are listed for the public's information since they have been reported in previous agendas for the review of regulations.	These regulations establish rules under which attendance, pupil personnel services and student rights are administered in public schools. These regulations are promulgated under authority of the Public School Code of 1949 (P. L. 30, No. 14) Article XXVI-B, §§ 26-2601-B—26-2606-B.	Peter Garland (717) 787-3787
Special Education Services and Programs 22 Pa. Code, Chapter 14 and 22 Pa. Code, Chapter 342	September 1999, as proposed.	These regulations are necessary to establish procedures for the identification of students who are in need of special education services and programs and to set forth requirements and procedures for the delivery of those services and programs. The review of these current regulations will focus on current federal and state law regarding special education services and programs to ensure compliance, consistent and accurate terminology and application of existing provisions. These regulations will be published as a single regulation, Chapter 14. These regulations are promulgated under authority of the Public School Code of 1949 (P. L. 30, No. 14) (24 P. S. § 1-101—26-2606-B).	Peter Garland (717) 787-3787
School Buildings 22 Pa. Code, Chapter 21	The State Board of Education is not considering revisions to these regulations at this time. They are listed for the public's information since they have been reported in previous agendas for the review of regulations.	This regulation provides uniform standards and procedures for seeking Departmental approval in school building projects. These regulations are proposed under authority of the Public School Code of 1949 (P. L. 30, No.14) Article XXVI-B, §§ 26-2601-B—26-2606-B.	Peter Garland (717) 787-3787

<i>Regulation Being Considered</i>	<i>Proposed Date for Promulgation</i>	<i>Need and Legal Basis for Action</i>	<i>Agency Contact</i>
Higher Education General Provisions, Foreign Corporation Standards, Institutional Approval, Program Approval 22 Pa. Code, Chapters 31, 36, 40, 42	August 1999, as proposed.	These regulations are necessary to establish procedures for the approval and operation of institutions of higher education in the Commonwealth. Specific revisions are necessary to clarify the intent of the chapters, modify the time frame during which new institutions must achieve accreditation, update provisions for library and learning resources, and amend regulations to accommodate for-profit baccalaureate and higher education. These regulations are promulgated under authority of the Public School Code of 1949 (P. L. 30, No.14), Article XXVI-B, §§ 26-2601-B—26-2606-B.	Peter Garland (717) 787-3787
Branch Campuses for State-supported Institutions 22 Pa. Code, Chapter 34	The State Board of Education is no longer considering revisions to these regulations at this time. They are listed for the public's information since they have been reported in previous agendas for the review of regulations.	This regulation establishes procedures for the approval of branch campuses. These regulations are promulgated under authority of the Public School Code of 1949 (P. L. 30, No. 14), Article XXVI-B, §§ 26-2601-B—26-2606-B.	Peter Garland (717) 787-3787
Gifted Education 22 Pa. Code, Chapter 16	August 1999, as final.	These regulations establish separate rules for programs and services for gifted students apart from those established for other special needs students. Special education regulations (Chapters 14 and 342) are largely driven by federal action. Gifted education is a state program. Separation of enabling regulations will permit greater efficiency and effectiveness in program operations. These regulations are promulgated under authority of the Public School Code of 1949 (P. L. 30, No. 14), Article XXVI-B, §§ 26-2601-B—26-2606-B.	Peter Garland (717) 787-3787
Certification of Professional Personnel 22 Pa. Code, Chapter 49	August 1999, as final.	These regulations and revisions are necessary to ensure that those individuals preparing to be teachers receive a quality education and are competent to teach in the disciplines and areas for which they are certified. These regulations are promulgated under authority of the Public School Code of 1949 (P. L. 30, No. 14) Article XXVI-B, §§ 26-2601-B—26-2606-B.	Peter Garland (717) 787-3787
General Standards for Preparation of Professional Educators 22 Pa. Code, Chapter 354	December 1999, as proposed.	These standards will provide general requirements for programs which prepare professional educators in the Commonwealth. Pennsylvania colleges and universities must meet these standards to obtain or retain Pennsylvania Department of Education approval to conduct professional educator programs leading to Pennsylvania certification. These regulations are being promulgated under authority of 22 Pa. Code, Chapter 49.	Ron Simanovich (717) 783-9252

<i>Regulation Being Considered</i>	<i>Proposed Date for Promulgation</i>	<i>Need and Legal Basis for Action</i>	<i>Agency Contact</i>
College and University Security 22 Pa. Code, Chapter 33	September 1999, as final.	These regulations govern the responsibility of institutions of higher education for the provisions of college and university security information and the collection and reporting of crime statistics. Revisions are necessary to incorporate provisions for the establishment of and access to daily campus crime logs. These regulations are promulgated under authority of the College and University Security Information Act (P. L. 443, No. 73)(24 P. S. § 2502-1 to 2502-5).	Peter Garland (717) 787-3787
Program Standards and Eligibility Criteria for the Higher Education Opportunity Act 22 Pa. Code, Chapter 44	September 1999, as final.	These regulations establish program requirements and eligibility criteria for Act 101 programs in colleges and universities. Revisions update eligibility criteria to reflect current income levels. These regulations are promulgated under authority of (P. L. 423, No. 101 § 3 and 4)(24 P. S. § 2510-303, § 2510-304).	Peter Garland (717) 787-3787
Community Colleges 22 Pa. Code, Chapter 35	August 1999, as proposed.	These regulations govern the establishment and operation of community colleges and technical institutes. Revisions to reflect current practice are proposed in the formula calculating Full-Time Equivalent (FTE) Enrollments for reimbursement purposes. These regulations are promulgated under authority of the Public School Code of 1949 (P. L. 30, No. 14), Article XXVI-B, §§ 26-2601-B—26-2606-B.	Peter Garland (717) 787-3787
<b><i>EMERGENCY MANAGEMENT AGENCY</i></b>			
4 Pa. Code Chapter 116 "Radiation Emergency Response Fund"	July 1999, as final.	Needed to simplify grant program. Radiation Protection Act.	Mark Goodwin 717-651-2010
4 Pa. Code Chapter 117 "Radiation Transportation Emergency Response Fund"	July 1999, as final.	Needed to simplify grant program. Radiation Protection Act.	Mark Goodwin 717-651-2010
4 Pa. Code Chapter 120b "Public Safety Emergency Telephone Program"	December 1999, as proposed.	Required by Public Safety Emergency Telephone Act	Mark Goodwin 717-651-2010
4 Pa. Code Chapter 120c "Training and Certification Standards for 911 Emergency Communications Personnel"	December 1999, as proposed.	Required by Public Safety Emergency Telephone Act	Mark Goodwin 717-651-2010
4 Pa. Code Chapter 120d "911 performance Review and Quality Assurance Standards"	December 1999, as proposed.	Required by Public Safety Emergency Telephone Act	Mark Goodwin 717-651-2010

<i>Regulation Being Considered</i>	<i>Proposed Date for Promulgation</i>	<i>Need and Legal Basis for Action</i>	<i>Agency Contact</i>
<b>ENVIRONMENTAL HEARING BOARD</b>			
25 PA Code § 1021	Summer 1999, as final.	Revisions to the Board's Rules of Practice and Procedure have been proposed by the Board with the expectation that the final proposals will be published in the Pennsylvania Bulletin this summer. These revisions and additions to Chapter 1021 are meant to improve the practice and procedure before the Board and to provide the regulated community, the Department of Environmental Protection, and other potential litigants with more specific guidance on how to represent their interests before the Board. The legal basis for the regulation is § 5 of the Environmental Hearing Board Act (35 P. S. § 7515).	Kimberly Hafner 717-787-3483
<b>ENVIRONMENTAL PROTECTION</b>			
Chapters 91, 97 & 101 - Wastewater Management Clean Streams Law	August 1999, as final.	This proposal has been developed as a result of the Regulatory Basics Initiative (RBI) and Executive Order 1996-1 and consolidates references to related water pollution control requirements into a single source, Chapter 91. The proposal will provide the regulated community and DEP greater flexibility in implementing pollution prevention measures and will provide authority for DEP to issue general water quality management permits. Because several sections of this rulemaking pertain to animal manure (manure storage and land application), DEP delayed this final rulemaking until the Concentrated Animal Feeding Operation (CAFO) strategy was finalized. The CAFO Strategy was published in the Pennsylvania Bulletin on March 13, 1999. DEP published an Advance Notice of Final Rulemaking (ANFR) on April 24, 1999. The Water Resources Advisory Committee (WRAC) and the Agricultural Advisory Board (AAB) are reviewing the draft final amendments.	Milt Lauch, 717-787-8184
Chapter 72, Amendments to SEO Application Requirements for Certification Sewage Facilities Act	July 1999, as final.	This proposal streamlines the application requirements for certification of sewage enforcement officers (SEOs) by reducing the 40-day time period in which applicants must wait to take the SEO exam following completion of successful precertification training. DEP plans to expand the precertification program and offer the opportunity for successful candidates to take the exam immediately following precertification training. The amendment was reviewed by the State Board for Certification of Sewage Enforcement Officers and the Sewage Advisory Committee.	Jay Africa, 717-783-2941

<i>Regulation Being Considered</i>	<i>Proposed Date for Promulgation</i>	<i>Need and Legal Basis for Action</i>	<i>Agency Contact</i>
Chapters 92, 93, 95, 96 & 97 - Water Quality Amendments Clean Streams Law	April 2000, as final.	These revisions address several of the principles of the RBI and Executive Order 1996-1. The revisions reorganize these chapters into permitting, water quality standards and implementation chapters respectively and will make several modifications to the programs. DEP will publish an Advance Notice of Final Rulemaking this Fall to provide an opportunity for additional public comment before final rulemaking. The WRAC will review drafts of the final rulemaking, and the AAB will also be briefed.	Carol Young, 717-787-4686
Stream Redesignations - Hay Creek, et al. Clean Streams Law	September 1999, as final.	This final rulemaking package includes a number of streams/segments recommended for special water quality protection as the result of requests from the Pennsylvania Fish and Boat Commission (PFBC) and DEP's regional offices. Two short stream segments are recommended for removal from the special protection waters program due to historical degradation by acid mine drainage. One stream segment was determined to be correctly designated. This package was approved by the EQB as proposed rulemaking on June 17, 1997. The proposal was published for public comment on August 16, 1997, and the comment period closed September 30, 1997. Final rulemaking has been on hold pending revisions to the Commonwealth's antidegradation regulations, which were approved by the EQB on May 20, 1999.	Bob Frey, 717-787-9637
Stream Redesignations - Little Bush Kill, et al. Clean Streams Law	November 1999, as proposed.	This proposed rulemaking package contains the results of redesignation evaluations that included petitions for Little Bush Kill (Pike Co.), Lizard Creek (Schuylkill Co.), Frya Run (Northampton Co.), and West Branch Perkiomen and Oysterville Creeks (Berks Co.). It also includes the results of non-special protection studies, including one stream missing from Chapter 93, a redesignation requested by Trout Unlimited, and redesignation of a portion of the main stem of Swatara Creek (Schuylkill and Lebanon Cos.).	Bob Frey, 717-787-9637
Stream Redesignations - Grimes Run, et al. Clean Streams Law	December 1999, as proposed.	This is a reproposal of stream redesignations that the EQB remanded to DEP for additional evaluation. Two streams were restudied due to public opposition: Trout Run (York County), a petitioned stream, and Browns Run (Warren County), requested by the PFBC. The package also includes a small portion of the Cove Creek basin that was separated during rulemaking because of a technical concern, and a portion of Grimes Run that was remanded due to concerns by the PFBC.	Tom Barron, 717-787-9637



<i>Regulation Being Considered</i>	<i>Proposed Date for Promulgation</i>	<i>Need and Legal Basis for Action</i>	<i>Agency Contact</i>
Stream Redesignations - Brinton Run, et al. Clean Streams Law	March 2000, as proposed.	This proposed rulemaking package contains four petitions for Exceptional Value designation for streams in Chester County. They include three unnamed tributaries to Brandywine Creek locally known as Brinton, Wylie, and Renwick Runs and an unnamed tributary to the East Branch Chester Creek. The package also includes redesignation evaluations requested by the PFBC for Rambo Run (York Co.) and Lost Creek (Juniata Co.).	Bob Frey, 717-787-9637
Stream Redesignations - Buck Hill Creek, et al. Clean Streams Law	April 2000, as final.	This final rulemaking package includes recommendations resulting from evaluation of special protection redesignation petitions for Buck Hill Creek (Monroe Co.) and Trout Run (Westmoreland Co.). It also includes a number of special protection redesignation requests from the PFBC and one from a DEP regional office. It also contains a recommended use designation for a stream currently missing from Chapter 93. The package was approved as proposed rulemaking by the EQB on January 20, 1998. It was published for public comment on April 4, 1998, and the comment period closed June 3, 1998. This package has been on hold pending revisions to the Commonwealth's antidegradation regulations, which were approved by the EQB on May 20, 1999.	Bob Frey, 717-787-9637
Stream Redesignations - Waltz Creek, et al. Clean Streams Law	June 2000, as proposed.	This proposed stream redesignation package consists primarily of requests from DEP regional offices, including redesignation of Beaver Creek (Schuylkill Co.) to High Quality-Cold Water Fishes as a result of a PFBC study. It also includes a use attainability evaluation for a portion of the main stem of Indian Creek (Fayette Co.) that is missing from Chapter 93 and a use attainability study for the headwaters of Black Creek (Carbon Co.) that is misrepresented in Chapter 93. A special protection evaluation will be conducted on Dreck Creek, a tributary to Black Creek.	Bob Frey, 717-787-9637
Stream Redesignations - Tohickon Creek, et al. Clean Streams Law	September 2000, as proposed.	This proposed rulemaking package is composed of evaluations resulting from four petitions to the EQB: Tohickon Creek (Bucks Co.), Smithtown Creek (Bucks Co.), Maiden and Sacony Creeks (Berks Co.), and Fishing Creek (Clinton Co.).	Bob Frey, 717-787-9637
Chapter 102, Erosion Control Clean Streams Law	September 1999, as final.	This rulemaking includes minor revisions such as eliminating obsolete terms, simplifying technical requirements for control facilities, updating and clarifying permit requirements to reflect current Federal NPDES permit requirements for construction activities, revising requirements that may be interpreted as more restrictive than Federal requirements, and establishing a minimum area of disturbance to require the development of an erosion and sedimentation control plan. The WRAC and the AAB will review drafts of the final rulemaking.	Ken Murin, 717-787-6827

<i>Regulation Being Considered</i>	<i>Proposed Date for Promulgation</i>	<i>Need and Legal Basis for Action</i>	<i>Agency Contact</i>
Chapter 103, Financial Assistance Stream Improvements Law	November 1999, as proposed.	This proposal includes revisions to Sections 103.41 - 103.63 pertaining to reimbursement for flood control projects by establishing additional categories of work eligible for reimbursement by DEP. These categories are necessary for consistency with the U.S. Army Corps of Engineers' current procedures for nonfederal cost sharing. In addition, the proposal establishes procedures to allow DEP to provide grants to local agencies for nonfederal watershed, stream channel and stream corridor restoration projects which would be conducted in partnership with DEP, the conservation district, federal agencies, local citizen volunteer groups and other agencies and organizations.	Gene Council, 717-787-3411
Chapter 105, Dam Safety and Waterway Management Clean Streams Law, Dam Safety and Encroachment Act	October 1999, as proposed.	Revisions will be proposed to simplify and clarify the regulations, streamline the process for minor wetland encroachments, establish discretion to issue expedited permit decisions during site visits, simplify the application fee schedule, and clarify the Chapters 105 and 106 programs by consolidating rules and procedures for stream channels, floodways and floodplains into one regulation. The Wetlands Protection Advisory Committee (WetPAC) is reviewing the issues. The AAB is also being briefed on developments. The date for EQB consideration of a proposed rulemaking remains tentative at this time pending WetPAC's deliberations.	Ken Reisinger, 717-787-6827
Municipal Waste Amendments Solid Waste Management Act	November 1999, as final.	This proposal changes the environmental assessment requirements to evaluate known and potential environmental harms vs. social and economic benefits; includes revisions to ICW permit by rule and general permit requirements; includes standards for nuisance minimization and control; modifies the closure requirements and assessment and abatement standards to be consistent with the Act 2 regulations and federal Subtitle D criteria; revises the planning and grant procedures; revises isolation distances; changes the equivalency review procedure for municipal waste permits so that once approval is given, it may be applicable statewide; revises the facility design and operating standards for composting facilities to be more performance based; revises leachate sampling requirements to delete parameters from quarterly sampling if groundwater protection will not be compromised; and allows for leachate holding tanks and trucking for some processing facilities in lieu of connection to sewer systems or building treatment plants. The draft final rulemaking will be reviewed by SWAC.	Bill Pounds, 717-787-7564

<i>Regulation Being Considered</i>	<i>Proposed Date for Promulgation</i>	<i>Need and Legal Basis for Action</i>	<i>Agency Contact</i>
Residual Waste Amendments Solid Waste Management Act	November 1999, as final.	This proposal changes the definition of waste and related terms to be similar to the solid waste definitions in RCRA Subtitle C; revises definitions and final closure standards to be consistent with the Act 2 regulations; allows for industry wide coproduct determinations and recycling of scrap metal; revises performance standards for odor, noise and other nuisance control; revises isolation distances; modifies the environmental assessment requirements; revises the permit application fee and simplifies the approval process for demonstration facilities; revises the facility design and operating standards for composting facilities to be more performance based; revises leachate sampling requirements to delete parameters from quarterly sampling if groundwater protection will not be compromised; allows for leachate holding tanks and trucking for some processing facilities in lieu of connection to sewer systems or building treatment plants; and modifies the attenuating soil requirements at landfills to allow for equivalency modeling based upon site specific conditions. The draft final regulations will be reviewed by SWAC.	Bill Pounds, 717-787-7564
Waste Oil Amendments Solid Waste Management Act	February 2000, as final.	This proposal consolidates the requirements for the management of used oil into one chapter. The SWAC approved the draft amendments and will review the draft final rulemaking at meetings in September and November 1999.	Scott Walters, 717-787-7381
Universal Waste Rule - Addition of Wastes Solid Waste Management Act	July 1999, as proposed.	The Universal Waste Rule allows certain hazardous wastes to be managed under requirements that are less prescriptive than full RCRA hazardous waste Subtitle C regulation. This proposal adds fluorescent tubes, unbroken mercury lamps and mercury-containing devices to the list of wastes managed as universal wastes. These items were petitioned for inclusion by Advanced Environmental Recycling Corporation in August 1997. The draft final rulemaking was reviewed by SWAC.	Rick Shipman, 717-787-6239
Amendments to Nitrogen Oxides (NOx) Allowance Requirements Air Pollution Control Act	August 1999, as final.	The proposal corrects accounting errors contained in Appendix E of the NOx allowance regulations published November 1, 1997. The amendments also add missing sources to Appendix E; clarify that the definition of "NOx-affected source" is applicable to fossil-fired operating units which generate greater than 15 MW of electricity; eliminate the special allocation for Washington Power project since its plan approval expired; delete the listing of "baseline MMBtu" in Appendix E and modify the listing of "baseline NOx lb/MMBtu." The AQTAC reviewed the draft final amendments.	Dean Van Orden, 717-787-4310

<i>Regulation Being Considered</i>	<i>Proposed Date for Promulgation</i>	<i>Need and Legal Basis for Action</i>	<i>Agency Contact</i>
Nitrogen Oxides (NOx) SIP Call Air Pollution Control Act	August 1999, as final.	This proposal is necessary for Pennsylvania to adopt a NOx reduction program for large stationary sources to achieve the emission reductions required by EPA's Section 110 State Implementation Plan (SIP) Call which was finalized October 27, 1998. The SIP Call was promulgated to mitigate interstate transport of ozone and its precursors which is interfering with the ability of many states to attain the one- and eight-hour National Ambient Air Quality Standards (NAAQS). Both the proposed and final amendments were reviewed by AQTAC.	Dean Van Orden, 717-787-4310
Emissions of Nitrogen Oxides (NOx) from Combustion Units and Process Heaters Air Pollution Control Act	February 2000, as proposed.	As one of the recommendations of the Southeast Pennsylvania Stakeholders Working Group to achieve additional NOx reductions, this proposal would require operators of certain combustion units and process heaters with rated heat inputs between 100 million and 250 million Btus (MMBtus) per hour to implement NOx reduction programs. Facilities would be required to meet an emission reduction program that has a cost effectiveness of less than \$3,000 per ton. This proposal is estimated to affect approximately 10 facilities with 35 to 40 units in the Southeast Pennsylvania area. The AQTAC will review a draft of the proposal in October 1999.	Terry Black, 717-787-4310
New Source Review Air Pollution Control Act	Contingent on EPA action.	The Department's existing new source review regulations will be reorganized and reformatted to make the requirements clear to the regulated community and to facilitate the creation and use of emission reduction credits. The Department will incorporate proposed changes in the Federal new source review requirements as necessary. Drafts of the proposal will be reviewed by the AQTAC. EPA has proposed in its draft new source review (NSR) regulations a number of mechanisms related to generation and use of Emission Reduction Credits (ERC's), and the use of an "area wide" plantwide applicability limit (PAL) to address trading issues. The proposed rules were issued in July 1996; however, EPA has not yet issued final rules. With the uncertainty of the nature of the final rules, the Department cannot proceed with revisions of the existing trading regulations until the final EPA rule is promulgated.	Terry Black, 717-787-4310

<i>Regulation Being Considered</i>	<i>Proposed Date for Promulgation</i>	<i>Need and Legal Basis for Action</i>	<i>Agency Contact</i>
Gasoline Volatility Requirements - Low RVP Air Pollution Control Act	July 1999, as final.	The Commonwealth is required to implement control strategies to demonstrate that the Pittsburgh-Beaver Valley Area will achieve the national ambient air quality standards (NAAQS) for ozone. The Department proposes to delete the term "federal reformulated gasoline or RFG" and eliminate RFG from the term "compliant fuel." The proposed regulation will limit the volatility of gasoline sold in the Pittsburgh-Beaver Valley Area each year between May 1 and September 15. The proposal requires the sale of 7.8 Reid vapor pressure (RVP) gasoline. In addition, the Department proposes to clarify the records retention requirements in Section 126.302(c) that records be kept on site. The AQTAC reviewed a draft of the final rulemaking.	Terry Black 717-787-4310
Surface Coating Processes Air Pollution Control Act	November 1999, as final.	This regulation will simplify the calculation procedure for determining compliance with Chapter 129 and consider small source exemptions to the extent possible without degrading air quality. The proposed rulemaking was published March 6, 1999. Four public hearings were held statewide during the 60-day public comment period. The AQTAC will review the draft final regulations.	Terry Black, 717-787-4310
Mobile Equipment Repair and Refinishing Air Pollution Control Act	August 1999, as final.	The Southwest and Southeast Ozone Stakeholder Working Groups recommended that DEP adopt programs to reduce VOC emissions from automobile refinishing. The proposed regulations establish maximum VOC content levels for automobile refinish materials used in the Commonwealth. The proposed regulation also establishes permitting requirements, pollution prevention and work practice standards. DEP is developing public information materials to inform the regulated industry of the proposed requirements. DEP published the proposal in August 1998 and conducted statewide public information meetings and hearings during the public comment period. The AQTAC reviewed the draft final regulations on May 21, 1999.	Terry Black, 717-787-4310
Solvent Cleaning Operations Air Pollution Control Act	April 2000, as final.	The Southwest and Southeast Ozone Stakeholder Working Groups recommended that DEP adopt Programs to reduce VOC emissions from degreasing operations. The proposed regulations will establish requirements for solvent cleaning operations not presently regulated by the provisions of Section 129.63. A stakeholder group consisting of degreaser manufacturers and operators, solvent suppliers and environmental groups met several times over an eight-month period to develop a draft regulation. The AQTAC reviewed a draft of the rulemaking. The proposal is anticipated to be published in July with a 60-day public comment period and three public hearings.	Terry Black, 717-787-4310

<i>Regulation Being Considered</i>	<i>Proposed Date for Promulgation</i>	<i>Need and Legal Basis for Action</i>	<i>Agency Contact</i>
Chapter 240, Radon Certification Radon Certification Act	No publication anticipated in the next six months.	DEP conducted workshops attended by selected individuals from the Pennsylvania certified radon community to discuss possible amendments to the current regulations which appear to be of concern to the regulated community and which do not fully address new technologies that were developed since the effective date of the 1991 radon certification regulations in Chapter 240. Meanwhile, EPA privatized its Radon Proficiency Program in October 1998. The National Environmental Health Association (NEHA) was selected to run a one-year pilot test of the EPA draft criteria document for the Certification of Radon Service Providers, the Accreditation of Radon Chambers and Laboratories, and the Approval of Measurement Devices. DEP's Radon Division is working closely with the NEHA on efforts to establish certification exams and other criteria that could possibly parallel suggested changes in DEP Radon Certification regulations.	Michael Pyles, 717-783-3594
Radiological Health (Chapters 215, 217, 219, 220, 224, 225, 226, 230 and 232) Radiation Protection Act	October 1999, as proposed.	The Department is updating its regulations for the control of radioactive material in preparation for becoming an Agreement State with the U.S. Nuclear Regulatory Commission (NRC). One of the NRC requirements for the agreement is to have and maintain compatible regulations with the NRC. The proposed regulations address industrial radiography, well logging, irradiators, medical uses, transportation and packaging, protection standards and licensing. The Department is consulting with the Radiation Protection Advisory Committee (RPAC) in developing these regulations.	William Kirk, 717-783-9730
Chapter 86, Subchapters A and D - General Provisions and Areas Unsuitable for Mining Surface Mining Conservation and Reclamation Act, Clean Streams Law, Coal Refuse Disposal Control Act	July 1999, as final.	The amendments address regulations which are more stringent than federal requirements, lack clarity, and which are inconsistent with language used in federal regulations. An Advance Notice of Final Rulemaking was published on January 30, 1999. The Mining and Reclamation Advisory Board (MRAB) reviewed the ANFR and draft final rulemaking.	David Hogeman, 717-787-4761
Storage, Handling and Use of Explosives Explosives Act, Surface Mining Control and Reclamation Act (SMCRA), and Noncoal SMCRA	February 2000, as proposed.	Amendments are being proposed to reflect changes that have occurred in the industry and the experience DEP has gained in implementing the program since the regulations in Chapters 210 and 211 were developed in 1972. The proposed amendments will address requirements which are needlessly more stringent and burdensome than federal requirements; will incorporate technological advances resulting from research on the effects of blasting on structures; and will enhance DEP's ability to prevent issuance of blasters' licenses to previous violators. DEP conducted public outreach meetings from September through December 1998. The MRAB will review the draft proposed regulations.	Michael Getto, 717-783-9892

<i>Regulation Being Considered</i>	<i>Proposed Date for Promulgation</i>	<i>Need and Legal Basis for Action</i>	<i>Agency Contact</i>
Amendments to Chapter 78 (Oil and Gas Wells) Oil and Gas Act, Clean Streams Law, Solid Waste Management Act	April 2000, as proposed.	The proposed revisions will clarify several sections relating to drilling, casing and cementing standards; requirements for drilling through gas storage reservoirs; plugging requirements; bonding requirements; and environmental performance standards. The Oil and Gas Technical Advisory Board (TAB) will review the draft amendments.	James Erb, 717-772-2199
<b>GENERAL SERVICES</b>			
Surplus State Property 4 Pa. Code, Chapter 41	Winter 1999, as proposed.	With the enactment of the Commonwealth Procurement Code (Act 57 of 1998) this Chapter must be substantially amended. Further, there is a need for review and revision of these regulations to implement improvements in the transfer and disposition of state surplus property.	Barbara L. Shelton (717) 787-5295
Responsibility 4 Pa. Code Chapter 60	Fall 1999, as proposed.	This chapter must be amended to conform with the legislative changes produced by Act 57.	Gary F. Ankabrandt (717) 783-1982
Instructions to Bidders 4 Pa. Code, Chapter 61	Fall 1999, as proposed.	This Chapter has been superseded and should be repealed because such instructions should not be set out in regulatory form. There is a need for flexibility which can be of benefit to the Department as well as bidders.	Merle H. Ryan (717) 787-7095
General Conditions of the Construction Contract 4 Pa. Code, Chapter 63	Fall 1999, as proposed.	See comment for Chapter 61.	Merle H. Ryan (717) 787-7095
State Art Commission 4 Pa Code, Chapter 65	Fall 1999, as proposed.	The legislation creating the State Art Commission was sunsetted.	Merle H. Ryan (717) 787-7095
Emergency Construction Repairs 4 Pa. Code, Chapter 67	Winter 1999, as proposed.	The regulation should be amended to more accurately reflect present practice and to delete contract provisions. Such provisions should not be in regulatory form and their deletion will serve the same purpose as noted for Chapter 61.	Merle H. Ryan (717) 787-7095
Contract Compliance 4 Pa. Code, Chapter 68	Fall 1999, as proposed.	Executive Order 1996-8 transferred the contract compliance responsibilities to the Department of General Services	John R. McCarty (717) 783-8720
Methods of Awarding Contracts 4 Pa. Code, Chapter 69	Winter 1999, as proposed.	With the enactment of the Commonwealth Procurement Code (Act 57) it is necessary to conform this Chapter with the changes in the law and to address other procurement areas affected by Act 57.	Barbara L. Shelton (717) 787-5295
Commonwealth Parking Facilities 4 Pa. Code, Chapter 71	Winter 1999, as proposed.	Amendments are required because parking locations have been changed.	James W. Martin (717) 783-5028
Commonwealth Automotive Fleet 4 Pa. Code, Chapter 73	Winter 1999, as proposed.	The regulation will be amended to eliminate the requirement for a Pennsylvania license to drive a state vehicle and will permit out-of-state licenses.	Gary F. Ankabrandt (717) 783-1982

<i>Regulation Being Considered</i>	<i>Proposed Date for Promulgation</i>	<i>Need and Legal Basis for Action</i>	<i>Agency Contact</i>
Processing Subscriptions and Sales of Pennsylvania Code and Related Publications 4 Pa. Code, Chapter 81	Winter 1999, as proposed.	These regulations should be repealed since the Department of General Services' Bureau of Management Services no longer has responsibility for the processing of subscriptions and orders for the PA Code. The PA Code contractor is now responsible for the PA Code subscriptions. New regulations will be developed to address sales of Commonwealth publications in general.	John R. McCarty (717) 783-8720
First Amendment Rights 4 Pa. Code, Chapter 86	Winter 1999, as proposed.	The amendment will extend coverage of the statement of policy to the Philadelphia State Office Building, Pittsburgh State Office Building, Scranton State Office Building, and Reading State Office Building.	Gregory C. Santoro (717) 787-5599
Death Benefits for Survivors of Firemen and Law Enforcement Officers - 4 Pa. Code, Chapter 89	Winter 1999, as proposed.	Since Act 101 of June 24, 1976 (P. L. 424) was amended by Act 161 of 1994 (P. L. 1373), the regulations must be amended to reflect the legislative changes.	James W. Martin (717) 783-5028
<b>HEALTH</b>			
Emergency Medical Services 28 Pa. Code § 1001.1 et seq.	December 1999, as final.	The amendments to existing regulations will enhance the operation of the Emergency Medical Services System in the Commonwealth. Pursuant to the Emergency Medical Services Act, 35 P. S. §§ 6921-6938.	Kenneth E. Brody 717-783-2500
Personnel Administration in County Health Departments 28 Pa. Code § 13.1 et seq.  State Aid to Local Health Departments 28 Pa. Code § 15.1 et seq.	No publication anticipated in the next six months.	The amendments to existing regulations will make them consistent with current local health administration practices. Pursuant to the Local Health Administration Law, 16 P. S. §§ 12001-12028.	Kenneth E. Brody 717-783-2500
Organized Camps and Campgrounds 28 Pa. Code § 19.1	No publication anticipated in the next six months.	These regulations are being considered for review and updating in part because of the transfer of authority for certain environmental regulations to the Department of Health. Pursuant to 71 P. S. § 532 and 71 P. S. §§ 1340.101 et seq.	Kenneth E. Brody 717-783-2500
Head Injury Program 28 Pa. Code § 14.1 et seq.	November 1999, as final.	These new regulations will facilitate the implementation of this program. Pursuant to the Emergency Medical Services Act, 35 P. S. § 6934(e).	Kenneth E. Brody 717-783-2500
Public Bathing Place Lifeguard Requirements 28 Pa. Code § 18.1; § 18.42	November 1999, as final.	The amendments to existing regulations will provide lifeguard requirements for recreational swimming establishments, and add requirements for lifeguard certification and factors to be considered in determining adequate lifeguard coverage. Pursuant to Act 75 of 1998, amending 35 P. S. §§ 672-680d (the Public Bathing Law).	Kenneth E. Brody 717-783-2500
Health Facility Licensure—Hospices 28 Pa. Code § 651.1 et seq.	November 1999, as proposed.	These new regulations will establish standards for the licensure and regulation of hospices. Pursuant to Act 95 of 1998, amending the Health Care Facilities Act, 35 P. S. § 448.101 et seq.	Kenneth E. Brody 717-783-2500



<i>Regulation Being Considered</i>	<i>Proposed Date for Promulgation</i>	<i>Need and Legal Basis for Action</i>	<i>Agency Contact</i>
Hearing Aid Sales Registration 28 Pa. Code § 25.201 et seq.	October 1999, as proposed.	The amendments to existing regulations will prescribe continuing education requirements for hearing aid fitters and update regulations regulating hearing aid sales. Pursuant to Act 153 of 1998, amending the Hearing Aid Sales Registration Act, 35 P. S. § 6700-101 et seq.	Kenneth E. Brody 717-783-2500
Drug and Alcohol Confidentiality 4 Pa. Code § 255.1 et seq. and § 257.1 et seq.	March 2000, as proposed.	These regulations are being reviewed for updating and to address concerns regarding availability of records of patients being treated for drug and alcohol related problems. Pursuant to the Pennsylvania Drug and Alcohol Abuse Control Act, 71 P. S. §§ 1690.101-1690.115.	Keith Fickel 717-783-2500
Drug and Alcohol Facility Physical Plant Standards 28 Pa. Code § 705.1 - 705.29	October 1999, as proposed.	The amendments to existing regulations will establish uniform standards for all residential and non-residential services. Pursuant to the Pennsylvania Drug and Alcohol Abuse Control Act, 71 P. S. §§ 1690.101-1690.115.	Keith Fickel 717-783-2500
Dental Laboratories 28 Pa. Code § 25.301 et seq.	No publication anticipated in the next six months.	These new regulations are needed to establish standards for the operation of laboratories in dental offices. Pursuant to the Controlled Substance, Drug, Device and Cosmetic Act, 35 P. S. § 780-101 et seq.	Keith Fickel 717-783-2500
Communicable Diseases 28 Pa. Code § 27.1 et seq.	November 1999, as proposed.	The amendments to existing regulations will make them consistent with current public health practices for the control of communicable and other reportable conditions. Pursuant to the Disease Prevention and Control Law of 1955, 35 P. S. §§ 521.1-521.21.	Yvette Kostelac 717-783-2500
Managed Care Organizations 28 Pa. Code 9.1 et seq.	September 1999, as proposed.	The amendments to existing regulations will update standards governing health maintenance organizations, and supersede statements of policy pertaining to integrated delivery systems and improving quality health care accountability and protection for managed care organizations. Pursuant to the Health Maintenance Organization Act, 40 P. S. §§ 1551-1567, and Act 68 of 1998, amending the Insurance Company Law of 1921, 40 P. S. § 341 et seq.	Yvette Kostelac 717-783-2500
Home Health Care Agencies 28 Pa. Code § 601.1 et seq.	No publication anticipated in next six months.	The amendments to existing regulations will provide for consistency with federal conditions of participation in Medicare programs. Pursuant to the Health Care Facilities Act, 35 P. S. § 448.101 et seq.	Carol Somerset-Griffie 717-783-2500
Birth Centers 28 Pa. Code § 501.1 et seq.	No publication anticipated in next six months.	The amendments to existing regulations will incorporate proposed newborn screening regulations. Pursuant to the Health Care Facilities Act, 35 P. S. § 448.101 et seq.	Carol Somerset-Griffie 717-783-2500
Health Facility Licensure— Long Term Care Facilities 28 Pa. Code § 201.1 et seq.	July 1999, as final.	The amendments to existing regulations will update standards regulating long term nursing care facilities, and will incorporate many of the federal long-term care certification regulations. Pursuant to the Health Care Facilities Act, 35 P. S. § 448.101 et seq.	James T. Steele, Jr. 717-783-2500
Health Facility Licensure— Ambulatory Surgical Facilities 28 Pa. Code § 551.1 et seq.	August 1999, as final.	The amendments to existing regulations will update the standards for ambulatory surgical facilities. Review occurred due to sunset of Certificate of Need. Pursuant to the Health Care Facilities Act, 35 P. S. § 448.101 et seq.	James T. Steele, Jr. 717-783-2500

<i>Regulation Being Considered</i>	<i>Proposed Date for Promulgation</i>	<i>Need and Legal Basis for Action</i>	<i>Agency Contact</i>
Health Facility Licensure— General & Special Hospitals & Health Planning 28 Pa. Code § 301.1 et seq. 28 Pa. Code § 401.1 et seq.	August 1999, as final-omitted.	Repeal of chapters on health planning (federal program and certificate of need), as statutory authority for both chapters has terminated. Pursuant to the Health Care Facilities Act, 35 P. S. § 448.101 et seq.	James T. Steele, Jr. 717-783-2500
Health Facility Licensure— General Administrative Chapter & General and Special Hospitals 28 Pa. Code § 101.1 et seq.	January 2000, as proposed.	The amendments to existing regulations will update the licensure standards for general and special hospitals. Pursuant to the Health Care Facilities Act, 35 P. S. § 448.101 et seq.	James T. Steele, Jr. 717-783-2500
Special Supplemental Food Program for Women, Infants and Children (WIC Program) 28 Pa. Code § 1101. et seq.	August 1999, as proposed.	Revisions to State WIC regulations necessary to comply with changes in the Federal regulations (7 C.F.R. § 246) relating to sanctions, disqualification actions and civil money penalties. Federal regulations require State compliance by May 17, 2000.  Concurrent with the changes mandated by new Federal regulations, the Department will also conduct a full review of all aspects of WIC Program operation contained in the State regulations.	Lesa E. Tressler 717-783-2500
Environmental Health Assessment 28 Pa. Code § 17.1 et seq.	No publication anticipated in the next six months.	These regulations are being considered for review and updating in part because of the transfer of authority for certain environmental regulations to the Department of Health. Pursuant to 71 P. S. § 532 and 71 P. S. §§ 1340.101 et seq.	Kenneth E. Brody 717-783-2500
<b>HOUSING FINANCE AGENCY</b>			
No regulations being developed or considered at this date.			
<b>INFRASTRUCTURE INVESTMENT AUTHORITY</b>			
Pennsylvania Infrastructure Investment Authority Financial Assistance, 25 Pa Code Chapter 963, Chapter 965, Water Pollution Control Revolving Fund	Winter 1999, as proposed.	The need for these amendments are twofold: First certain amendments to Chapter 963 will notify the public of certain less onerous regulatory requirements for obtaining a Letter of No Prejudice. Second, certain other amendments to existing regulations are necessary to clarify and inform the public of current agency policy, procedure and program requirements. The grant of authority to amend 25 Pa. Code Chapters 963 and 965 is set forth in Section 6(4)(i) of the Pennsylvania Infrastructure Investment Authority Act, 35 P. S. § 751.6(4)(i).	Brion Johnson (717) 783-6798  Jayne B. Blake (717) 783-6776
<b>INSPECTOR GENERAL</b>			
No regulations being developed or considered at this date.			
<b>INSURANCE</b>			
Allocation of Joint Expenses, 31 Pa. Code, Chapter 3, §§ 3.1-3.6	November 1999, as proposed.	Amend to be consistent with current NAIC accounting instructions and to expand the scope of the regulations to include life and health insurers in holding company systems.	Peter J. Salvatore, Regulatory Coordinator 717-787-4429
Miscellaneous (Relating to Uniform Classification of Expenses), 31 Pa. Code, Chapter 11, §§ 11.1-11.7	August 1999, as proposed.	Repeal §§ 11.2 and 11.5-7 to eliminate outdated, unnecessary regulations and amend § 11.4 to clarify current NAIC accounting instructions for electronic data processing expenses.	Peter J. Salvatore, Regulatory Coordinator 717-787-4429

<i>Regulation Being Considered</i>	<i>Proposed Date for Promulgation</i>	<i>Need and Legal Basis for Action</i>	<i>Agency Contact</i>
Costs of Examinations (EDP Expenses), 31 Pa. Code, Chapter 12, §§ 12.1-12.7	October 1999, as proposed.	Amend to clarify the various types of costs incurred in the conduct of department examinations.	Peter J. Salvatore, Regulatory Coordinator 717-787-4429
Stock Ownership Statements, 31 Pa. Code, Chapter 21, §§ 21.1-21.103	October 1999, as proposed.	Amend to update requirements relating to Stock Ownership Statements consistent with NAIC model language.	Peter J. Salvatore, Regulatory Coordinator 717-787-4429
Proxies, Consents and Authorizations, 31 Pa. Code, Chapter 23, §§ 23.1-23.96	October 1999, as proposed.	Amend to update requirements relating to Proxies, Consents and Authorizations consistent with NAIC model language.	Peter J. Salvatore, Regulatory Coordinator 717-787-4429
Acquisitions of Capital Stock (Insurance Company Holding Law), 31 Pa. Code, Chapter 25, §§ 25.1-25.23	July 1999, as proposed.	Amend to be consistent with 1993 amendments to the authorizing statute and to eliminate unnecessary filing requirements	Peter J. Salvatore, Regulatory Coordinator 717-787-4429
Advances to Mutual, Stock and Life Companies (NEW Chapter 105a)	June 1999, as proposed.	New regulation to address surplus notes issued by mutual stock and life companies consistent with authorizing statute adopted in 1992.	Peter J. Salvatore, Regulatory Coordinator 717-787-4429
Assigned Risk Plan, 31 Pa. Code, Chapter 33, § 33.29	July 1999, as final.	Repeal current regulation and replace regulation with new chapter (31 Pa. Code, Chapter 67a) to be consistent with Pennsylvania Assigned Risk Plan	Peter J. Salvatore, Regulatory Coordinator 717-787-4429
Surplus Lines, Chapter 35, §§ 35.1-35.22	August 1999, as final.	Repeal current regulations, 31 Pa. Code, Chapters 35 (and Chapter 123) and replace with one updated regulation relating to surplus lines insurance consistent with 1992 statutory amendments.	Peter J. Salvatore, Regulatory Coordinator 717-787-4429
Producer Licensing, 31 Pa. Code, Chapter 37, §§ 37.1-37.84	October 1999, as proposed.	Amend 31 Pa. Code, Chapter 37, Agent Certificates of Qualification and Broker Licenses, consistent with statutory amendments in Act 72 of 1996 and 40 of 1997.	Peter J. Salvatore, Regulatory Coordinator 717-787-4429
Producer Licensing, 31 Pa. Code, Chapter 39, §§ 39.1-39.22	October 1999, as proposed.	Amend Chapter 39 relating to continuing education for agents and brokers consistent with statutory amendments in Act 72 of 1996.	Peter J. Salvatore, Regulatory Coordinator 717-787-4429
Reserves of Beneficial Societies, 31 Pa. Code, Chapter 43, §§ 43.1-43.2	November 1999, as proposed.	Repeal pursuant to Executive Order 1996-1.	Peter J. Salvatore, Regulatory Coordinator 717-787-4429
Advertising of Insurance, 31 Pa. Code, Chapter 51, §§ 51.1-51.61	August 1999, as proposed.	Amend pursuant to Executive Order 1996-1.	Peter J. Salvatore, Regulatory Coordinator 717-787-4429

<i>Regulation Being Considered</i>	<i>Proposed Date for Promulgation</i>	<i>Need and Legal Basis for Action</i>	<i>Agency Contact</i>
Special Rules of Administrative, Practice and Procedure, 31 Pa. Code, Chapter 56, §§ 56.1-56.3	October 1999, as proposed.	Amend pursuant to Executive Order 1996-1.	Peter J. Salvatore, Regulatory Coordinator 717-787-4429
Objections and Procedure for Hearings on Reports of Examination, 31 Pa. Code, Chapter 58, §§ 58.1-58.3	October 1999, as proposed.	Repeal to eliminate outdated, unnecessary requirements consistent with the new examination law adopted in 1992 (40 P. S. §§ 323.1 - 323.8).	Peter J. Salvatore, Regulatory Coordinator 717-787-4429
Cancellations and Refusal to Renew Homeowners Insurance, 31 Pa. Code, Chapter 59, §§ 59.1-59.13	August 1999, as proposed.	Amended language to regulation and statute is being drafted pursuant to Executive Order 1996-1.	Peter J. Salvatore, Regulatory Coordinator 717-787-4429
Notices for and Appeals of Cancellations and Refusals to Renew Automobile Insurance Policies, 31 Pa. Code, Chapter 61, §§ 61.1-61.14	August 1999, as proposed.	Modify regulation consistent with the statute (40 P. S. §§ 1008.1 et seq.). The regulations provide guidance to automobile insurers relating to cancellations and nonrenewals of certain automobile insurance policies, and the available administrative process to secure an administrative review of such terminations.	Peter J. Salvatore, Regulatory Coordinator 717-787-4429
Physical Damage Appraisers, 31 Pa. Code, Chapter 62, §§ 62.1-62.4	August 1999, as final.	Amend pursuant to Executive Order 1996-1.	Peter J. Salvatore, Regulatory Coordinator 717-787-4429
Uninsured Motorist Coverage, 31 Pa. Code, Chapter 63, §§ 63.1-63.3	September 1999, as proposed.	Amend pursuant to Executive Order 1996-1 and pending filing before the Department.	Peter J. Salvatore, Regulatory Coordinator 717-787-4429
Private Passenger Automobile Policy Forms, 31 Pa. Code, Chapter 64, §§ 64.1-64.14	September 1999, as final.	Repeal pursuant to Executive order 1996-1.	Peter J. Salvatore, Regulatory Coordinator 717-787-4429
Charter Amendments, 31 Pa. Code, Chapter 65, §§ 65.21-26	August 1999, as proposed.	Amend to eliminate outdated, unnecessary provisions relating to minimum capital and surplus requirements pursuant to Executive Order 1996-1.	Peter J. Salvatore, Regulatory Coordinator 717-787-4429
Collision Loss Settlements, 31 Pa. Code, Chapter 65, §§ 65.11-14	July 1999, as final.	Repeal pursuant to Executive Order 1996-1.	Peter J. Salvatore, Regulatory Coordinator 717-787-4429
Motor Vehicle Financial Responsibility Law - Evidence of Financial Responsibility, 31 Pa. Code, Chapter 67, §§ 67.21-28	August 1999, as final.	Amend pursuant to Executive Order 1996-1.	Peter J. Salvatore, Regulatory Coordinator 717-787-4429
Pennsylvania Assigned Risk Consumer Protections, (NEW Chapter 67a)	July 1999, as final.	Amend pursuant to Executive Order 1996-1. This will replace 31 Pa. Code § 33.29.	Peter J. Salvatore, Regulatory Coordinator 717-787-4429

<i>Regulation Being Considered</i>	<i>Proposed Date for Promulgation</i>	<i>Need and Legal Basis for Action</i>	<i>Agency Contact</i>
Life Insurance Illustrations (New)	October 1999, as proposed.	Act 154 of 1996 provides for life insurance illustration requirements for life insurance policies. The statute sunsets when a life insurance illustration regulation becomes effective. A life insurance illustration regulation will eliminate misleading illustrations, make illustrations more understandable, and standardize terms and illustration formats for the entire life insurance industry. Further, it is more appropriate that technical requirements, such as these, appear in a regulation rather than in statutory form.	Peter J. Salvatore, Regulatory Coordinator 717-787-4429
Replace Life Insurance Annuities, 31 Pa. Code, Chapter 81, §§ 81.1-9	September 1999, as proposed.	Amend pursuant to Executive Order 1996-1.	Peter J. Salvatore, Regulatory Coordinator 717-787-4429
Variable Life Insurance, 31 Pa. Code, Chapter 82, §§ 82.1-91	September 1999, as proposed.	Amend pursuant to Executive Order 1996-1.	Peter J. Salvatore, Regulatory Coordinator 717-787-4429
Disclosure in Solicitation of Life Insurance, 31 Pa. Code, Chapter 83, §§ 83.1-57	August 1999, as proposed.	Amend pursuant to Executive Order 1996-1.	Peter J. Salvatore, Regulatory Coordinator 717-787-4429
Minimum Reserve Standards for Individual and Group Health and Accident Insurance Contracts, 31 Pa. Code, Chapter 84a, §§ 84a.1-84a.8	August 1999, as final.	Amend pursuant to Executive Order 1996-1.	Peter J. Salvatore, Regulatory Coordinator 717-787-4429
Actuarial Opinion & Accumulation Contracts, 31 Pa. Code, Chapter 84b, §§ 84b.1-84b.11	November 1999, as proposed.	Amend pursuant to Executive Order 1996-1.	Peter J. Salvatore, Regulatory Coordinator 717-787-4429
Variable Annuity & Accumulation Contracts, 31 Pa. Code, Chapter 85, §§ 85.1-85.40	September 1999, as proposed.	Amend pursuant to Executive Order 1996-1.	Peter J. Salvatore, Regulatory Coordinator 717-787-4429
Premium & Retirement Deposit Fund, 31 Pa. Code, Chapter 86, §§ 86.1-86.12	August 1999, as proposed.	Amend pursuant to Executive Order 1996-1.	Peter J. Salvatore, Regulatory Coordinator 717-787-4429
Requirements for Life Policies and Sales Practices, 31 Pa. Code, Chapter 87, §§ 87.1-87.42	October 1999, as proposed.	Amend pursuant to Executive Order 1996-1.	Peter J. Salvatore, Regulatory Coordinator 717-787-4429
Individual Accident & Sickness Minimum Standards, 31 Pa. Code, Chapter 88, §§ 88.1-88.195	October 1999, as proposed.	Amend pursuant to Executive Order 1996-1.	Peter J. Salvatore, Regulatory Coordinator 717-787-4429

<i>Regulation Being Considered</i>	<i>Proposed Date for Promulgation</i>	<i>Need and Legal Basis for Action</i>	<i>Agency Contact</i>
Accident and Health Insurance Regulation, 31 Pa. Code, Chapter 89, §§ 89.1-89.11 and § 89.17	October 1999, as proposed.	Changes will be promulgated regarding the deregulation of rates and forms filings for accident and health insurance, as a result of Act 159 of 1996. Changes will be made pursuant to the health care provisions of the Federal Health Insurance Portability and Accountability Act of 1996.	Peter J. Salvatore, Regulatory Coordinator 717-787-4429
Preparation of Forms, etc., 31 Pa. Code, Chapter 89, §§ 89.12-16, 89.18-89.62 and 89.101	August 1999, as proposed.	Amend pursuant to Executive Order 1996-1.	Peter J. Salvatore, Regulatory Coordinator 717-787-4429
Medicare Supplement, 31 Pa. Code, Chapter 89, §§ 89.777,89.890 and Appendix E	September 1999, as final.	Amend regulation to add Medicare Select provisions.	Peter J. Salvatore, Regulatory Coordinator 717-787-4429
Separate Accounts for Principle and Interest Guarantees, 31 Pa. Code, Chapter 90a, §§ 90a.1-90a.31	September 1999, as proposed.	Amend pursuant to Executive Order 1996-1.	Peter J. Salvatore, Regulatory Coordinator 717-787-4429
Cash Advances to Insurance Companies 31 Pa. Code, Chapter 105, §§ 105.1-105.2	November 1999, as proposed.	Amend to reflect statutory amendments adopted in 1992 and 1995 and to eliminate outdated, unnecessary provisions relating to cash advancements to insurance companies pursuant to Executive Order 1996-1.	Peter J. Salvatore, Regulatory Coordinator 717-787-4429
Policies Covering Personal Property Pledged as Collateral, 31 Pa. Code, Chapter 112, §§ 112.1-112.12	July 1999, as proposed.	Amend pursuant to Executive Order 1996-1.	Peter J. Salvatore, Regulatory Coordinator 717-787-4429
Consent to Rate Filings, 31 Pa. Code, Chapter 113, §§ 113.1-113.9	July 1999, as proposed.	Repeal pursuant to Executive Order 1996-1.	Peter J. Salvatore, Regulatory Coordinator 717-787-4429
Public Adjusters, 31 Pa. Code, Chapter 115, §§ 115.1-115.8	July 1999, as proposed.	The regulation was initially promulgated to clarify the requirements of public adjuster contracts. The authorizing statute, Act 72, was amended in 1983 (63 P. S. §§ 1601-1608), and the Insurance Department seeks to modify Chapter 115 to be consistent with the revised statutory language. Additionally, three sections have been proposed for deletion since they mirror the Act.	Peter J. Salvatore, Regulatory Coordinator 717-787-4429
Discounting Workers' Compensation Loss Reserves, 31 Pa. Code, Chapter 116, §§ 116.1-116.9	July 1999, as proposed.	Blend regulations on discounting of loss reserves into one regulation consistent with Executive Order 1996-1.	Peter J. Salvatore, Regulatory Coordinator 717-787-4429
Discounting Medical Malpractice Loss Reserve, 31 Pa. Code, Chapter 118, §§ 118.1-118.6	July 1999, as proposed.	Blend regulations on discounting of loss reserves into one regulation consistent with Executive Order 1996-1.	Peter J. Salvatore, Regulatory Coordinator 717-787-4429

<i>Regulation Being Considered</i>	<i>Proposed Date for Promulgation</i>	<i>Need and Legal Basis for Action</i>	<i>Agency Contact</i>
Surplus Lines, 31 Pa. Code, Chapter 123, §§ 123.1-123.63	August 1999, as final.	Repeal current regulations, 31 Pa. Code, Chapters 123 (and Chapter 35) and replace with one updated regulation relating to surplus lines insurance consistent with 1992 statutory amendments.	Peter J. Salvatore, Regulatory Coordinator 717-787-4429
Surplus Lines, 31 Pa. Code, (NEW Chapter 124, §§ 124.1-124.10)	August 1999, as final.	Repeal two current regulations, 31 Pa. Code, Chapters 35 and 123 and replace with one updated regulation relating to surplus lines insurance consistent with 1992 statutory amendments.	Peter J. Salvatore, Regulatory Coordinator 717-787-4429
Management Contracts or Exclusive General Agent Agreements, 31 Pa. Code, Chapter 127, §§ 127.1-127.8	September 1999, as proposed.	Amend pursuant to Executive Order 1996-1	Peter J. Salvatore, Regulatory Coordinator 717-787-4429
Preparation of Filing of Property and Casualty Forms for Approval, 31 Pa. Code, Chapter 133, §§ 133.1-133.12	September 1999, as proposed.	Repeal pursuant to Executive Order 1996-1.	Peter J. Salvatore, Regulatory Coordinator 717-787-4429
Description of Reserves - Prohibited Phrases, 31 Pa. Code, Chapter 139, §§ 139.1-139.3	October 1999, as proposed.	Amend pursuant to Executive Order 1996-1.	Peter J. Salvatore, Regulatory Coordinator 717-787-4429
Unfair Insurance Practices; Unfair Claims Settlement Practices, 31 Pa. Code, Chapter 146, §§ 146.1-146.10	October 1999, as proposed.	Amend pursuant to Executive Order 1996-1.	Peter J. Salvatore, Regulatory Coordinator 717-787-4429
Securities Held Under Custodial Agreements, 31 Pa. Code, Chapter 148, §§ 148.1-148.4	November 1999, as proposed.	Amend to eliminate unnecessary forms, add uniform requirements relating to custodial agreements and duties of custodians and update provisions relating to permissible custodians.	Peter J. Salvatore, Regulatory Coordinator 717-787-4429
Continuing Care Providers, 31 Pa. Code, Chapter 151, §§ 151.1-151.14	September 1999, as proposed.	Amend to be consistent with 1996 statutory amendments relating to the order of distribution of assets in insolvencies and to provide for the voluntary surrender of a certificate of authority.	Peter J. Salvatore, Regulatory Coordinator 717-787-4429
Contractual Agreements with Integrated Delivery Systems, 31 Pa. Code, Chapter 152, §§ 152.1-152.25	September 1999, as proposed.	Amend pursuant to Executive Order 1996-1.	Peter J. Salvatore, Regulatory Coordinator 717-787-4429
Quality Health Care Accountability and Protections, 31 Pa. Code, (NEW Chapter 154)	July 1999, as proposed.	Regulations are necessary to address outstanding issues and to fully implement the requirements of Act 68.	Peter J. Salvatore, Regulatory Coordinator 717-787-4429
Health Maintenance Organizations, 31 Pa. Code, Chapters 301, §§ 301.1-301.126	September 1999, as proposed.	Amend pursuant to Executive order 1996-1.	Peter J. Salvatore, Regulatory Coordinator 717-787-4429

<i>Regulation Being Considered</i>	<i>Proposed Date for Promulgation</i>	<i>Need and Legal Basis for Action</i>	<i>Agency Contact</i>
Underground Storage Tank Indemnification Fund - Fee Regulation, 25 Pa. Code, Chapter 971, §§ 971.1-971.4	August 1999, as proposed.	Repeal the existing regulation for the Underground Storage Tank Indemnification Fund (USTIF). This will be combined with Chapters 973 and 975 into a new regulation, Chapter 977.	Peter J. Salvatore, Regulatory Coordinator 717-787-4429
Underground Storage Tank Indemnification Fund - Fee Collections Regulation, Chapter 973, §§ 973.1-973.12	August 1999, as proposed.	Repeal the existing regulation for the Underground Storage Tank Indemnification Fund (USTIF). This will be combined with Chapters 971 and 975 into a new regulation, Chapter 977.	Peter J. Salvatore, Regulatory Coordinator 717-787-4429
Underground Storage Tank Indemnification Fund - Voluntary Heating Oil Tank Program, 25 Pa. Code, Chapter 975, §§ 975.1-975.6	August 1999, as proposed.	Repeal the existing regulation for the Underground Storage Tank Indemnification Fund (USTIF). This will be combined with Chapters 971 and 973 into a new regulation, Chapter 977	Peter J. Salvatore, Regulatory Coordinator 717-787-4429
Underground Storage Tank Indemnification Fund - Claims Regulation, 25 Pa. Code, (NEW Chapter 977)	August 1999, as proposed.	Requires underground storage tank owners be in compliance with certain leak detection standards in order to obtain claims coverage from the Underground Storage Tank Indemnification Fund. The proposed regulation establishes requirements for owners to file such claims. This will combine most of 25 Pa. Code, Chapters 971, 973 and 975.	Peter J. Salvatore, Regulatory Coordinator 717-787-4429
<b>LABOR AND INDUSTRY</b>			
Workers' Compensation Bureau, Workers' Compensation Judges, and Workers' Compensation Appeal Board regulations at 34 Pa. Code Chapters 131, 121, and 111.	Fall 1999, as proposed.	These rules have not been updated in many years; they need to reflect the changes in the law and practice of workers' compensation.	Thomas J. Kuzma (717) 783-4467
Work-place Safety Committee Certification; Evaluation of Accident/Illness Prevention Services & Programs of Insurers and Self-insureds; Qualifications of Accident/Illness Prevention Service Providers 34 Pa. Code Chapter 129	June 1999, as proposed.	The rulemaking implements the health and safety provisions of Article X of the Workers' Compensation Act. The proposed rulemaking specifies the safety committee certification application and renewal processes, and it establishes the necessary program components and evaluation criteria for accident and illness prevention programs maintained or provided by licensed insurers and self-insured employers. In addition, the regulation ensures the uniform application of the provisions of Article X; amends sections 123.202 pertaining to the qualifications of vocational experts; and, amends section 125.133(c)(4) and 125.155 (a) of the self-insurance regulations.	Len Negley (717) 772-1917
Underground Storage Facilities	October 2000, as proposed.	This regulation will address requirements for natural or man-made caverns used for LPG storage.	James Varhola (717) 787-3329
Dry Cleaning	June 2000, as proposed	Dry Cleaning Law, Act of December 19, 1990, P. L. 1327, No. 214, 35 P. S. 1270.1 et seq. This proposal will regulate the construction, operation and maintenance of dry cleaning plants.	Edward Leister (717) 787-3323



<i>Regulation Being Considered</i>	<i>Proposed Date for Promulgation</i>	<i>Need and Legal Basis for Action</i>	<i>Agency Contact</i>
Personal Care Homes Housing Immobile Residents 34 Pa. Code Chapters 49, 55 & 56.	June 1999, as proposed.	The regulation is a result of the Act of December 21, 1988, P. L. 1883, No. 185, which permitted the housing of immobile persons in personal care homes. The current Fire and Panic Regulations for personal care homes require personal care home occupants to be both physically and mentally capable of taking appropriate measures for self-preservation with minimal supervision in the event of a fire. They are not designed to provide a fire safe environment for immobile persons. The proposed regulations will require the installation of an automatic sprinkler system in personal care homes which house immobile residents.	Edward L. Leister (717) 787-3323
Pennsylvania Minimum Wage Act, Food Service Incentive Program Regulations	November 1999, as proposed.	The Department is required to promulgate new regulations to implement the new "Food Service Incentive Program" added, via amendment to the Minimum Wage Act and signed into law on December 21, 1998.	Lisa DeLorenzo (717) 772-9192
Unemployment Compensation Regulations, Title 34. Labor & Industry Regulations	Summer 2000, as proposed.	The proposed regulation will clarify the circumstances under which individuals will not be eligible for unemployment compensation (UC) based on services for an educational institution or educational service agency during summer vacation or school break periods.	Robert Allen (717) 783-7644
Asbestos Occupations Accreditation and Certification	June 2000, As proposed.	Act of December 19, 1990, P. L. 05, No. 194, 64 P. S. §§ 2101-2112. This regulation established the Department's worker certification and training provider accreditation program. It also sets up training course requirements. It is based on the Environmental Protection Agency's model plan.	Sharon Lawson (717) 772-3396
<b>MEDICAL PROFESSIONAL LIABILITY CATASTROPHE LOSS FUND</b>			
No regulations being developed or considered at this date.			
<b>MILITARY AND VETERANS AFFAIRS</b>			
State Veterans Home 43 Pa. Code Section 7.1 et. seq.	October 1999, as proposed.	This regulation is necessary to update current regulations, make them more user-friendly. This regulation is a long-term project and would amend 43 Pa. Code Chapter 7.	Eclenus Wright, Jr. 717-861-8503
<b>PARDONS</b>			
No regulations being developed or considered at this date.			
<b>PENNSYLVANIA MUNICIPAL RETIREMENT SYSTEM</b>			
16 Pa. Code Chapters 81, 83, 85, 87 and 91	Publication anticipated within six months	These regulations are in the process of review as a result of Executive Order 1996-1.	James B. Allen (717) 787-2065
<b>PROBATION AND PAROLE</b>			
Definitions 37 PA. Code, Chapters 61.1 - 75.4	November 1999, as proposed.	The Board plans to amend a number of regulations. Definitions amended pursuant to Executive Order 1996-1 and to conform to statutory changes.	Vicki Wilken 717-787-6208

<i>Regulation Being Considered</i>	<i>Proposed Date for Promulgation</i>	<i>Need and Legal Basis for Action</i>	<i>Agency Contact</i>
<b>PUBLIC SCHOOL EMPLOYEES' RETIREMENT SYSTEM</b>			
No regulations being developed or considered at this date			
<b>PUBLIC WELFARE</b>			
Child Protective Services Law 55 Pa. Code Ch. 3490	July 1999, as final	This regulation incorporates the amendments to the child protective services law as a result of Act 151 of 1994 and Act 10 (Special Services No. 1) of 1995. The major changes are: provisions for investigating reports of suspected sexual abuse or exploitation or serious bodily injury by a school employee against a student; screening applicants for employment in schools against childline files to determine whether or not their names are on file as an abuser; and reports of neglect.	Tom Vracarich (717) 783-2209
Child Day Care Services 55 Pa. Code Chs. 3271, 3281, 3291	February 2000, as proposed	This regulation is proposed in response to Governor's Executive Order 1996-1 and to strengthen health and safety requirements in the regulation. The regulation will impact child day care centers, group day care homes and family day care homes. 55 Pa. Code, Chapter 3300, Specialized Day Care Service for Children with Disabilities, will be rescinded in order to comply with the provisions of the Americans With Disabilities Act.	Tom Vracarich (717) 783-2209
Medical assistance estate recovery 55 Pa. Code Ch. 258	October 1999, as proposed	This regulation will codify the department's collection practices to recover correctly paid MA from the estates of certain deceased recipients age 55 or older who receive Medical Assistance for nursing facility care, home and community based services, and related hospital prescription drug services. Changes effective August 15, 1994 and are the result of OBRA' 93, Act 1994-49, and Act 1995-20.	Tom Vracarich (717) 783-2209
Disclosure of social security number 55 Pa. Code Ch. 155	September 1999, as final	This regulation incorporates federal requirements that applicants for and recipients of benefits administered by the Department of Public Welfare are required to disclose or apply for a social security number as a condition of eligibility. This regulation will be reviewed by representatives of community legal service agencies, the welfare rights organization, and other similar client advocacy groups.	Tom Vracarich (717) 783-2209
Continuation of Medical Assistance throughout pregnancy. 55 Pa. Code Chs. 140, 181	March 2000, as final omitted	This regulation codifies the provision that Medical Assistance coverage will be continued for pregnant women throughout their pregnancy and postpartum period, regardless of changes in family income that occur after the authorization of MA or cash assistance. This regulation will be reviewed by representatives of community legal service agencies, the welfare rights organization, and other similar client advocacy groups.	Tom Vracarich (717) 783-2209

<i>Regulation Being Considered</i>	<i>Proposed Date for Promulgation</i>	<i>Need and Legal Basis for Action</i>	<i>Agency Contact</i>
Lump sum payments 55 Pa. Code Chs. 140, 181	September 1999, as final	This proposed regulation will require that any balance remaining of a lump sum that has been treated as income in the calendar month of receipt for the Medical Assistance eligibility determination is treated as a resource in subsequent months. This regulation will be reviewed by representatives of community legal service agencies, the welfare rights organization, and other similar client advocacy groups.	Tom Vracarich (717) 783-2209
Emergency Assistance Program 55 Pa. Code Chs. 141, 147, 289	September 1999, as final	This regulation eliminates the allocation of emergency assistance for housing under the cash grant line. Funding for this purpose will be transferred to the Office of Social Programs. This regulation will be reviewed by representatives of community legal service agencies, the welfare rights organization, and other similar client advocacy groups.	Tom Vracarich (717) 783-2209
Exclusion of Resources-Medical Assistance children 55 Pa. Code Chs. 140, 178	September 1999, as final omitted	This regulation codifies the provision that resources are excluded in the Medical Assistance eligibility determination process for supplemental security income (SSI) related, general assistance (GA) related, and TANF-related persons under 21 years of age and for SSI-related, TANF-related, and GA-related families with children under 21 years of age. This regulation will be reviewed by representatives of community legal service agencies, the welfare rights organization, and other similar client advocacy groups.	Tom Vracarich (717) 783-2209
Workfare/Community Service 55 Pa. Code Chs. 166, 275	January 2000, as proposed	The revisions clarify who may be assigned and the priority and factors to be considered in making Workfare program assignments, define responsibilities of county assistance offices and project operators regarding participation expenses and program requirements, and provide for grievance rights for Workfare recipients and regular employees. Provisions of Act 1995-20 will also be incorporated into this regulation package. This regulation will be reviewed by representatives of community legal service agencies, the welfare rights organization, and other similar client advocacy groups.	Tom Vracarich (717) 783-2209
General Assistance Restructure - Act 1994-49 55 Pa. Code Chs. 141, 145, 147, 166, 171, 178, 181	September 1999, as final omitted	This regulation incorporates provisions of Act 1994-49 including acceptance of written verification of medical disability for chronically needy non-financial eligibility determination; 60-day residency requirement; savings designated for educational purposes; and certain medical services which are no longer compensable expenses. This regulation will be reviewed by representatives of community legal service agencies, the welfare rights organization, and other similar client advocacy groups.	Tom Vracarich (717) 783-2209

<i>Regulation Being Considered</i>	<i>Proposed Date for Promulgation</i>	<i>Need and Legal Basis for Action</i>	<i>Agency Contact</i>
Elimination of transitionally needy component of general assistance program 55 Pa. Code Ch. 141	September 1999, as final omitted	This regulation codifies the elimination of cash assistance payments to persons in the GA-Transitional Needy ("TN") category. References to both the TN and chronically needy (CN) components are deleted since there is no longer a need to differentiate between GA program requirements. This regulation will be reviewed by representatives of community legal service agencies, the welfare rights organization, and other similar client advocacy groups.	Tom Vracarich (717) 783-2209
Act 1996-35 - General eligibility changes 55 Pa. Code Chs. 125, 141, 168, 171, 175, 177, 181, 183	September 1999, as final omitted	This regulation codifies statutory changes to eligibility conditions for General Assistance benefits, including the following: expanding the eligibility determination period to 30 days; establishing a period of residency; imposing ineligibility periods based on welfare fraud convictions; limiting Medically Needy Only/Medical Assistance ("MNO/MA") eligibility to certain groups; and revising the methodology used to determine eligibility for retroactive MNO/MA. This regulation will be reviewed by representatives of community legal service agencies, the welfare rights organization, and other similar client advocacy groups.	Tom Vracarich (717) 783-2209
Elimination of PACE requirement 55 Pa. Code Ch. 181	October 1999, as final omitted	This regulation codifies the elimination of the deduction from income for the PACE program and the mandate to enroll in the PACE program as required by Title XIX. This regulation will be reviewed by representatives of community legal service agencies, the welfare rights organization, and other similar client advocacy groups.	Tom Vracarich (717) 783-2209
Real property liens 55 Pa. Code Chs. 101, 121, 177, 183, 257, 297	March 2000, as proposed	This regulation codifies the elimination of the requirement that applicants who own real property, including mobile homes, which are used as their primary residence, will no longer be required to sign a lien encumbering their residence as a condition of eligibility for cash assistance. The Department intends to rescind 55 Pa. Code Chapter 257, regarding Reimbursement. Instead, the Department will propose a new chapter governing reimbursement policy for cash assistance recipients and applicants who own personal property. This regulation will be reviewed by representatives of community legal service agencies, the welfare rights organization, and other similar client advocacy groups.	Tom Vracarich (717) 783-2209
Criminal history 55 Pa. Code Chs. 125, 133, 141	October 1999, as final omitted	This regulation incorporates the Act 1995-20 provision that prohibits the granting of assistance to any person sentenced for a felony or misdemeanor who has not satisfied the penalty imposed by law by having completed the period of incarceration and by paying all fines, costs, and restitution. Act 1996-35 expands the satisfied penalty requirement to include compliance with an approved payment plan. This regulation will be reviewed by representatives of community legal service agencies, the welfare rights organization, and other similar client advocacy groups.	Tom Vracarich (717) 783-2209

<i>Regulation Being Considered</i>	<i>Proposed Date for Promulgation</i>	<i>Need and Legal Basis for Action</i>	<i>Agency Contact</i>
Act 1996-35 - Provisions Effective March 3, 1997 55 Pa. Code Chs. 105, 125, 133, 140, 141, 145, 151, 153, 165, 168, 177, 178, 181, 183, 187, 255	October 1999, as final omitted	This regulation incorporates provisions of the TANF program implemented 3/3/97 by NORC including establishing RESET; requiring applicants and recipients to enter into an agreement of mutual responsibility with the department; and further defining Title IV-D cooperation requirements and procedures for TANF and GA applicants and recipients. Act 1996-35 provisions applicable to the TANF program may not be implemented until federal approval is received. This regulation will be reviewed by representatives of community legal service agencies, the welfare rights organization, and other similar client advocacy groups.	Tom Vracarich (717) 783-2209
Medical support rights 55 Pa. Code Ch. 187	January 2000, as proposed	This regulation will require Medical Assistance applicants/ recipients to assign their medical support rights to the Commonwealth and apply for Title IV-D support services as conditions of eligibility. This regulation will be reviewed by representatives of community legal service agencies, the welfare rights organization, and other similar client advocacy groups.	Tom Vracarich (717) 783-2209
Annuity rule 55 Pa. Code Ch. 178	June 2000, as final omitted	This regulation codifies the provision that in addition to the current provision permitting the institutionalized spouse to provide part of his monthly income to the community spouse whose income is below the minimum monthly maintenance needs allowance, either the institutionalized spouse or their representative may file an appeal and seek an administrative order permitting the protection of additional resources to enable the community spouse to purchase an annuity that will generate sufficient income to bring her income up to the minimum monthly maintenance needs allowance. This regulation will be reviewed by representatives of community legal service agencies, the welfare rights organization, and other similar client advocacy groups.	Tom Vracarich (717) 783-2209
Intentional Program Violations 55 Pa. Code Chs. 255, 275, 501	September 1999, as final omitted	This regulation incorporates federal mandates by the U.S. Department of Agriculture and the U.S. Department of Health and Human Services that individuals found to have committed an intentional program violation be subject to an immediate disqualification penalty regardless of the individual's current eligibility status for benefits. This regulation will be reviewed by representatives of community legal service agencies, the welfare rights organization, and other similar client groups.	Tom Vracarich (717) 783-2209

<i>Regulation Being Considered</i>	<i>Proposed Date for Promulgation</i>	<i>Need and Legal Basis for Action</i>	<i>Agency Contact</i>
Expansion of Income Limits - Qualifying Individuals 1 and 2 55 Pa. Code Ch. 140	September 1999, as final omitted	This regulation codifies the revisions needed to comply with the Balanced Budget Act of 1997 for the expansion of Medicare Part B premiums. Full payment of the Medicare Part B premium is available to individuals with income at 120% of the Federal Poverty Income Guidelines (FPIG) but less than 135% of the FPIG. Partial payment of the premium is available to individuals with income at 135% of the FPIG but less than 175% of the FPIG. This regulation will be reviewed by representatives of community legal service agencies, the welfare rights organization, and other similar client advocacy groups.	Tom Vracarich (717) 783-2209
Medical Assistance Closure 55 Pa. Code Chs. 140, 148	December 1999, as proposed	This proposed regulation removes references to the closing of MA benefits using the cash payment date schedule to designate the closure date. The proposed regulations state that Medical Assistance benefit eligibility ends after the required notice is forwarded to the recipient and the corresponding appeal period expires. This regulation will be reviewed by representatives of community legal service agencies, the welfare rights organization, and other similar client advocacy groups.	Tom Vracarich (717) 783-2209
Early and Periodic Screening Diagnosis Treatment (EPSDT) 55 Pa. Code Chs. 1101, 1121, 1123, 1147, 1241	November 1999, as final omitted	This regulation relating to services provided as a follow-up to an EPSDT visit or encounter that are not currently recognized under the approved Medical Assistance (Medical Assistance) State Plan. This regulation will be reviewed by the medical assistance advisory committee (MAAC) which includes representatives of professional provider associations, providers, the health law project, the welfare rights organization, consumers, and client advocacy groups.	Tom Vracarich (717) 783-2209
Medical Assistance case management services 55 Pa. Code Ch. 1239	January 2000, as final omitted	This final regulation codifies payment for medically necessary case management services as mandated by Omnibus Budget Reconciliation Act '89 to Medical Assistance recipients under the age of 21. This regulation will be reviewed by the MAAC, as noted above.	Tom Vracarich (717) 783-2209
General Assistance Restructure - Act 1994-49 55 Pa. Code Chs. 1101, 1121, 1149	November 1999, as final omitted	This final regulation codifies Act 1994-49 provisions that affect the medical benefits of General Assistance recipients over the age of 21 when these services are solely state funded. These recipients are no longer eligible for (1) dental services unless their medical condition or handicap requires services to be provided in an ambulatory surgical center, short procedures unit or inpatient hospital; (2) medical supplies and equipment except as prescribed for family planning or with home health agency service; and (3) prescription drugs except legend birth control drugs. This regulation will be reviewed by the MAAC, as noted above.	Tom Vracarich (717) 783-2209
Discontinue coverage - infertility 55 Pa. Code Chs. 1121, 1126, 1129, 1141, 1163, 1221, 1225, 1243	November 1999, as final omitted	This final regulation codifies Act 1994-49 provisions that discontinues payment for all drugs, devices, products, services and procedures that are used or related to treating infertility, including surrogacy services, effective September 1, 1994. This regulation will be reviewed by the MAAC, as noted above.	Tom Vracarich (717) 783-2209

<i>Regulation Being Considered</i>	<i>Proposed Date for Promulgation</i>	<i>Need and Legal Basis for Action</i>	<i>Agency Contact</i>
Residential Treatment Facilities (RTF) for mental health services 55 Pa. Code Chs. 1157, 1165	January 2000, as final omitted	This regulation codifies coverage for mental health services to children under 21 years of age that are provided in a residential treatment facility. This regulation will be reviewed by the MAAC, as noted above.	Tom Vracarich (717) 783-2209
Pharmaceutical services drug coverage 55 Pa. Code Ch. 1121	November 1999, as final omitted	This regulation provides that the medical assistance program provides drug coverage to medically needy only recipients receiving nursing facility services. This includes medically needy only recipients who reside in nursing facilities and intermediate care facilities/mental retardation (ICF/MR). This regulation will be reviewed by the MAAC, as noted above.	Tom Vracarich (717) 783-2209
\$150 deductible for General Assistance recipients 55 Pa. Code Ch. 1101	November 1999, as final omitted	This regulation implements Act 1996-35 provisions imposing a \$150 deductible on inpatient and outpatient hospital services and ambulatory surgical center services, except laboratory and x-ray services for General Assistance and General Assistance-related Medical Assistance recipients. This regulation will be reviewed by the MAAC, as noted above.	Tom Vracarich (717) 783-2209
Early Intervention Services 55 Pa. Code Chs. 4225, 4226	December 1999, as proposed	This regulation will establish program regulations for early intervention services in keeping with the Federal regulations under the Individuals with Disabilities Education Act (IDEA) and Act 212 of 1990. Early intervention services regulations are called for by the Legislative Budget and Financing Committee Report on early intervention services.	Tom Vracarich (717) 783-2209
MH Wraparound 55 Pa. Code Ch. 1154	January 2000, as final omitted	This final regulation codifies requirements necessary to receive reimbursement for medically necessary outpatient wraparound mental health services for individuals under 21 years of age with a diagnosis of mental illness or emotional disturbance. This regulation will be reviewed by the MAAC, as noted above.	Tom Vracarich (717) 783-2209
Family Planning 55 Pa. Code Ch. 1101	November 1999, as final omitted	This final regulation removes family planning clinics from the list of providers limited under the General Assistance Basic Health Care Package to 18 practitioner's office and clinic visits per year. This regulation will be reviewed by the MAAC, as noted above.	Tom Vracarich (717) 783-2209
Physician Assistant/Midwife 55 Pa. Code Ch. 1141	November 1999, as final omitted	This final regulation codifies revised supervision requirements for physician assistants and midwives. This regulation will be reviewed by the MAAC, as noted above.	Tom Vracarich (717) 783-2209
Discontinuance of the Mandatory Second Opinion Program 55 Pa. Code Ch. 1150	November 1999, as final omitted	This final regulation removes the mandatory second opinion program requirement for certain surgical procedures. This regulation will be reviewed by the MAAC, as noted above.	Tom Vracarich (717) 783-2209
D&A Clinics 55 Pa. Code Ch. 1223	November 1999, as final omitted	This final regulation revises the enrollment policy for outpatient drug and alcohol clinics. This regulation will be reviewed by the MAAC, as noted above.	Tom Vracarich (717) 783-2209
Capital Component Payment for Replacement Beds 55 Pa. Code Ch. 1187	January 2000, as proposed	This regulation takes the policy as set forth in the Statement of Policy and promulgates it into the regulations. This regulation will be reviewed by the MAAC.	Tom Vracarich (717) 783-2209

<i>Regulation Being Considered</i>	<i>Proposed Date for Promulgation</i>	<i>Need and Legal Basis for Action</i>	<i>Agency Contact</i>
Intergovernmental Transfer 55 Pa. Code Ch. 1187	December 1999, as final omitted	This regulation will extend the county nursing facility Transition Rates according to the Intergovernmental Transfer Agreement. This regulation will be reviewed by the MAAC.	Tom Vracarich (717) 783-2209
New Definition of "Emergency Medical Condition" 55 Pa. Code Chs. 1101, 1141, 1150, 1221	October 1999, as final omitted	This final regulation codifies the revised definition of "emergency medical condition" contained in the Balanced Budget Act of 1997, effective July 1, 1998. This regulation will be reviewed by the MAAC, as noted above.	Tom Vracarich (717) 783-2209
Definition of Medically Necessary 55 Pa. Code Ch. 1101	January 2000, as proposed	This proposed regulation replaces the current definition of "medically necessary" with the definition found in the HealthChoices Request for Proposal. This regulation will be reviewed by the MAAC, as noted above.	Tom Vracarich (717) 783-2209
<b>REVENUE</b>			
Books, Publications and Advertising Materials 61 Pa. Code § 31.29	Fall 1999, as final.	The Department is amending § 31.29 (relating to books, printed matter and advertising materials) in response to statutory changes and inquiries from the public.	Douglas A. Berguson 717-787-1382
Compensation; Allowable Deductions From Gross Compensation and Deferred Compensation Arrangements 61 Pa. Code §§ 101.6, 101.6a and 101.6b	Fall 1999, as proposed.	The Department is amending §§ 101.6 and adding 101.6a and 101.6b to set forth its interpretation of current case law and current policy in the areas of compensation; commonly recognized old age or retirement benefits; reimbursements of business expenses; and guaranteed payments.	Douglas A. Berguson 717-787-1382
Credits Against Tax; Estimated Tax 61 Pa. Code §§ 111.2 - 111.5, 115.1 - 115.5, 115.8, 115.9 and 115.11 - 115.12	Winter 2000, as proposed.	This regulation sets forth the Department's policy relating to taxes for which credit is not allowed; other conditions for allowance of the credit for taxes paid to other states; limitations on the amount of the credit for taxes paid to other states; proof requirements; jointly paid estimated tax; and application of overpayments of estimated tax. This regulation is necessary to delete obsolete text; add language consistent with statutory changes; and provide additional guidance in areas that have been subject to questions from the public.	Douglas A. Berguson 717-787-1382
Commercial Motion Pictures 61 Pa. Code § 32.38	Summer 1999, as final.	The Department is setting forth its interpretation of section 2 of Act 7-1997, section 204(54) (72 P. S. § 7204(54)) regarding the sales and use tax exclusion for the sale at retail to or use by a producer of commercial motion pictures of any tangible personal property directly used in the production of a feature-length commercial motion picture distributed to a national audience.	Douglas A. Berguson 717-787-1382
Computer Software and Related Transactions 61 Pa. Code § 31.33	Fall 1999, as proposed.	Pursuant to Act 7-1997, various types of computer services are no longer subject to sales and use tax on or after July 1, 1997. However, certain computer related transactions remain subject to tax. This regulation provides guidance concerning these transactions.	Douglas A. Berguson 717-787-1382



<i>Regulation Being Considered</i>	<i>Proposed Date for Promulgation</i>	<i>Need and Legal Basis for Action</i>	<i>Agency Contact</i>
Definitions; Net Profits and Regulated Investment Companies 61 Pa. Code §§ 101.1, 103.12 and 155.30	Summer 1999, as final.	Section 101.1 (relating to definitions) is being amended by replacing the existing definitions of "employee" and "employer" with new definitions consistent with the requirements of 72 P. S. § 7301(g) and (h). The definition of "income" is being expanded to implement the provisions of 72 P. S. § 7602(f)(2)(A) and reflect recent holdings in <i>Morgan v. Commonwealth</i> , 42 Pa. Commonwealth Ct. 557, 400 A.2d 1384 (1979) and <i>Wettach v. Commonwealth</i> , 153 Pa. Commonwealth Ct. 293, 620 A.2d 730 (1993). Section 103.12 (relating to net profits) is also being amended to reflect <i>Morgan</i> and <i>Wettach</i> . The definition of "personal income tax income" set forth in § 155.30(b)(4) (relating to regulated investment companies) is being amended to provide that the term means income computed in the same manner and on the same basis as the income of an individual under Article V. Personal Income Tax.	Douglas A. Berguson 717-787-1382
Disclaimers of Nonprobate Taxable Assets 61 Pa. Code § 93.81	Summer 1999, as final.	The regulation sets forth specific conditions that must be met in order for a disclaimer executed in regard to nonprobate taxable assets and nontrust assets of resident decedents to be valid for Pennsylvania inheritance tax purposes. Based on the decision and order received from the Commonwealth Court In Re Estate of Bernecker, 654 A.2d 246 (Pa. Commonwealth 1995), the Department is revising its policy on the effectiveness of disclaimers of nonprobate taxable assets for Pennsylvania inheritance tax purposes.	Douglas A. Berguson 717-787-1382
File-by-phone (TeleFile) System and Federal and State Electronic Tax Filing Program 61 Pa. Code §§ 117.19 - 117.21	Fall 1999, as proposed.	The file-by-phone (TeleFile) program involves the filing of a Pennsylvania personal income tax return by phone. The Federal and State electronic tax filing program involves the filing of a Pennsylvania personal income tax return as part of the Federal and State Electronic Filing Program.	Douglas A. Berguson 717-787-1382
Lawn Care Services 61 Pa. Code §§ 55.6 and 60.2	Summer 1999, as proposed.	This regulation sets forth the Department's interpretation of Act 22-1991 (72 P. S. §§ 7201(k)(17), (o)(15) and (jj)) relating to lawn care services.	Douglas A. Berguson 717-787-1382
Local Tax 61 Pa. Code §§ 60.16, and 95.1 - 95.303	Fall 1999, as proposed.	This regulation sets forth the Department's interpretation of sections 501-509 of the Pennsylvania Intergovernmental Cooperation Authority Act for Cities of the First Class (53 P. S. §§ 12720.501 - 12720.509), sections 3150-B - 3157-B of the Second Class County Code (16 P. S. §§ 6150-B - 6157-B) and section 201-A of the Tax Reform Code of 1971 (72 P. S. § 7201-A). Currently the Department's interpretation is set forth as a pronouncement and codified at 61 Pa. Code § 60.16 (relating to local sales, use and hotel occupancy tax). The Department has concluded that its policy relating to local sales, use and hotel occupancy tax should be set forth as a regulation. Therefore, In addition to proposing to add Chapter 95. Local Tax, the Department is also proposing to delete the pronouncement set forth at § 60.16.	Douglas A. Berguson 717-787-1382

<i>Regulation Being Considered</i>	<i>Proposed Date for Promulgation</i>	<i>Need and Legal Basis for Action</i>	<i>Agency Contact</i>
Payments for Employee Welfare Benefit Plans and Cafeteria Plans 61 Pa. Code §§ 101.1, 101.6 and 101.7	Winter 1999, as final.	The amendments to §§ 101.1, 101.6, and 101.7 are being added to explain how employee welfare benefit programs and other wage and salary supplemental programs are taxed and to implement amendments to section 301(d) of the Tax Reform Code of 1971 (72 P. S. § 7306(d)) under Act 7-1997.	Douglas A. Berguson 717-787-1382
Sales and Use Tax Amendments 61 Pa. Code §§ 7.3, 7.6, 31.4, 31.5, 31.7, 31.26, 32.1 - 32.5, 32.21, 32.22, 32.31 - 32.37, 33.1, 33.2, 33.4, 42.1, 42.3, 44.2, 45.1, 46.9, 47.18 and 58.13	Fall 1999, as final.	The Department is proposing numerous amendments to the Pennsylvania Code, Title 61. This regulatory package is the result, in part, of a comprehensive review of sales and use tax regulations in light of legislative changes from 1991 to the present.	Douglas A. Berguson 717-787-1382
Telecommunications Service 61 Pa. Code §§ 31.1, 31.24, 48.1 and 55.8	Summer 1999, as final.	This regulation sets forth the Department's interpretation of the 1991 statutory changes set forth in section 201(m), 202(c) and 204(5) of the Tax Reform Code of 1971 (72 P. S. §§ 7201(m), 7202(c) and 7204(5)) regarding telephone, telegraph and telecommunications services.	Douglas A. Berguson 717-787-1382
Utility Gross Receipts Tax 61 Pa. Code §§ 160.21 - 160.43	Summer 1999, as proposed	The Department is proposing this regulation to clarify the changes to the utility gross receipts tax brought about by utility deregulation (Act 138-1996) codified in Title 15 and Title 66. This regulation will also provide guidance and clarity to out-of-state businesses and the emerging industry.	Douglas A. Berguson 717-787-1382
Vending Machines 61 Pa. Code § 31.28	Summer 1999, as proposed	This regulation sets forth the Department's interpretation of Act 45-1998 as it relates to vending machines.	Douglas A. Berguson 717-787-1382
<b>SECURITIES COMMISSION</b>			
Licensing Regulations 64 Pa. Code § 303 - § 404	October 1999, as proposed.	The Commission plans to amend a number of licensing regulations to conform them to the state preemption provisions of the federal National Securities Markets Improvement Act of 1996.	G. Philip Rutledge (717) 783-5130
Corporate Finance Regulations 64 Pa. Code § 202-209 64 Pa. Code § 504-513 64 Pa. Code § 606-609	June 1999, as proposed.	The Commission proposes to amend or adopt a number of regulations as a result of passage of Act 109 of 98, which amended the PA Securities Act of 1972.	G. Philip Rutledge (717) 783-5130
<b>STATE</b>			
Bureau of Commissions, Elections and Legislation	December 1999, as proposed.  September 1999, as proposed.	The Department proposes comprehensive revisions to regulations at 4 Pa. Code to eliminate obsolete provisions, and to reflect recent statutory changes. Amendments will be proposed pursuant to the Pennsylvania Voter Registration Act (25 P. S. § 961.301), the Pennsylvania Election Code (25 P. S. § 2601 et seq) and Campaign Expense Reporting Law (25 P. S. § 3241 et seq)  The Department proposes to eliminate outdated references to campaign finance reporting forms. The amendments will be proposed pursuant to the Campaign Expense Reporting Law (25 P. S. § 3241 et seq)	Richard Filling, (717) 787-5280

<i>Regulation Being Considered</i>	<i>Proposed Date for Promulgation</i>	<i>Need and Legal Basis for Action</i>	<i>Agency Contact</i>
State Athletic Commission 58 Pa. Code, Chapter 21	September 1999, as proposed.	Comprehensive revisions to 58 Pa. Code will reflect statutory changes to the Pennsylvania Athletic Code and changes in commission procedures. The regulations will be promulgated pursuant to the Pennsylvania Athletic Code (5 Pa.C.S.A. § 101 et seq).	Greg Sirb (717) 787-5720
Navigation Commission for the Delaware River and Its Navigable Tributaries - 13 Pa. Code Ch. 201-209.	September 1999, as proposed.	Proposed comprehensive revisions will enhance navigational safety, eliminate obsolete regulations and reflect statutory changes pursuant to 55 P. S. § 31 and 71 P. S. § 670.2(4).	L. Lawrence Boyle (717) 787-6458
Bureau of Professional and Occupational Affairs - Schedule of Civil Penalties for Act 48 - State Boards of Accountancy, Architects, Auctioneers, Professional Engineers, Land Surveyors and Geologists, and Dentistry - 49 Pa. Code, Chapter 43	September 1999, as proposed.	The Boards propose to provide for civil penalties for violations pertaining to the conduct or operation of a business or facility licensed by the Board. Statutory authority: 63 P. S. § 2205(a).	Beth Sender Michlovitz (717) 783-7200
State Board of Auctioneer Examiners - Schedule of Fees - 49 Pa. Code § 1.41.	Fall 1999, as proposed.	The regulation revises the Board's schedule of fees to reflect the actual costs of the services provided. Statutory authority: 63 P. S. § 734.6.	Linda Dinger (717) 783-3397
State Board of Barber Examiners - General Revisions 49 Pa. Code, Chapter 3.	September, 1999, as proposed.	The Board proposes to revise and update its entire chapter and repeal antiquated provisions. Statutory authority: 63 P. S. § 566.4(b).	Sara Sulpizio (717) 783-3402
Verification/Certification Fees - 49 Pa. Code § 3.103.	Fall 1999, as proposed.	This regulation apportions costs of providing Board services to specific applicants and licensees Statutory authority: Section 14 of the Barber License Law, 63 P. S. § 564.	
State Board of Chiropractic - Sexual Misconduct - 49 Pa. Code § 5.54.	No publication anticipated in next six months.	Through the monitoring of its disciplinary process, including consumer complaints and disciplinary actions, the Board believes that enforcement standards are needed to notify licensees of acts which the Board deems unprofessional. Statutory authority: Section 302(3) of the Chiropractic Practice Act, 63 P. S. § 625.302(3).	Deb Smith (717) 783-7156
Peer Review - 49 Pa. Code § 5.55.	No publication anticipated in next six months.	The proposal would regulate standards for review of chiropractic treatment. The proposal would assure that when chiropractic diagnosis and treatment are subject to utilization review by chiropractors, appropriate standards will be employed. Statutory authority: Section 302(3), 63 P. S. § 625.302(3).	
Application Fees - 49 Pa. Code § 5.6.	Fall 1999, as proposed.	This regulation apportions costs of providing Board services to specific applicants and licensees. Statutory authority: 63 P. S. §§ 625.302(3) and 625.1101.	

<i>Regulation Being Considered</i>	<i>Proposed Date for Promulgation</i>	<i>Need and Legal Basis for Action</i>	<i>Agency Contact</i>
State Board of Cosmetology - Disinfection, Equipment and Supplies; - 49 Pa. Code §§ 7.71, 7.71a, 7.71b, 7.105, 7.113a and 7.114.	January 2000, as proposed.	These regulations reflect improved industry standards for disinfecting and sterilizing equipment required to be available in cosmetology shops. Minimum safety and sanitation standards are authorized under Section 11 of the Cosmetology Law, 63 P. S. § 517.	Sara Sulpizio (717) 783-7130
General Revisions - 49 Pa. Code, Chapter 7.	March 2000, as proposed.	These regulations will revise and update current rules and repeal outdated provisions. Statutory authority: 63 P. S. § 517.	
Safe use of Chemicals - 49 Pa. Code § 7.96.	March 2000, as proposed.	The Board will update and broaden standards to require licensees to follow manufacturers' instructions and FDA restrictions when using chemicals on clients. Statutory authority: 63 P. S. § 517.	
Examination Fees - 49 Pa. Code § 7.2	Summer 1999, as final.	The regulation amends the Board's fee schedule by revising the fees for the complete cosmetologist, cosmetician, manicurist or teacher examination and the manager theory examination. Current fees do not reflect actual contract costs for examination services which have increased as a result of a new contract with a professional testing organization. Statutory authority: 63 P. S. §§ 519(b) and 522(a).	
State Architects Licensure Board - Fees - 49 Pa. Code § 9.3.	Fall 1999, as proposed.	The regulation revises the Board's schedule of fees to reflect the actual costs of the services provided. Statutory authority: 63 P. S. §§ 34.6(d) and 34.11.	Dorna Thorpe (717) 783-1404
Completion of Architectural Work Initiated by a Deceased Architect - 49 Pa. Code Chapter 9.	December 1999, as proposed.	The new regulation is needed because the current regulations pertaining to the architect's seal do not provide adequate guidance as to allowable procedures for completion of a deceased architect's work. Statutory authority: 63 P. S. §§ 34.6(b), 34.6(d) and 34.12.	

<i>Regulation Being Considered</i>	<i>Proposed Date for Promulgation</i>	<i>Need and Legal Basis for Action</i>	<i>Agency Contact</i>
State Board of Accountancy - Continuing Education Program Sponsors - 49 Pa. Code §§ 11.1, 11.4, 11.64- 11.65, 11.66, 11.70-11.73, 11.80.	Summer 1999, as proposed.	The regulations require approved continuing education program sponsors to renew their approval biennially and authorize the Board to conduct audits of approved programs. The regulations ensure that continuing education programs meet licensure renewal needs. Statutory authority: 63 P. S. § 9.3(10).	Dorna Thorpe (717) 783-1404
Commissions and Referral Fees - 49 Pa. Code § 11.24.	Fall 1999, as proposed.	The regulation establishes requirements for licensees who pay or receive commissions and referral fees in connection with the referral or recommendation of products and services. The regulation complies with 1997 amendments to the C.P.A. Law. Statutory authority: 63 P. S. § 9.12(p).	
General Revisions - 49 Pa. Code, Chapter 11.	Fall 1999, as proposed.	The regulations repeal outdated requirements in compliance with 1997 amendments to the C.P.A. Law. Statutory authority: 63 P. S. § 9.3(10)-(12).	
Peer Review - 49 Pa. Code, §§ 11.81-11.86.	Summer 1999, as proposed.	The regulations clarify deadlines for peer review compliance; establish qualifications for peer review administering organizations, peer review team captains, and peer reviewers; adopt peer review standards; prescribe conditions for out-of-state peer reviews of multi-state firms; provide for confidentiality of peer review reports; and define relevant terms. The regulation implements 1997 amendments to the C.P.A. Law. Statutory authority: 63 P. S. §§ 9.8h and 9.8i.	
Fees - 49 Pa. Code § 11.4.	Summer 1999, as proposed.	The regulation revises the Board's schedule of fees to reflect the actual costs of the services provided. Statutory authority: 63 P. S. § 9.6.	
State Board of Funeral Directors - Pre-need Requirements - 49 Pa. Code, Chapter 13.	October 1999, as proposed.	The Board will update current regulations in order to provide clear and concise guidance to licensees regarding pre-need monies and contracts. Legal authority: Section 16(a) of the Funeral Director Law, Act of January 14, 1952, as amended, 63 P. S. § 479.16(a).	Cheryl Lyne (717) 783-3397
Application/Certification/ Verification/ Reinspection Fees - 49 Pa. Code § 13.12.	Fall 1999, as proposed.	The regulation revises the Board's schedule of fees to reflect the actual costs of the services provided. Statutory authority: 63 P. S. § 479.18.1.	
State Board of Landscape Architects - Continuing Education - 49 Pa. Code § 15.71-15.83.	September 1999, as final.	The amendments establish procedures and standards for continuing education as a condition of biennial renewal pursuant to Section 9.1 of the Landscape Architects Registration Law, Act of January 24, 1966, P. L. (1965) 1527, added by the Act of December 7, 1994, P. L. 774, 63 P. S. § 909.1.	Shirley Klinger (717) 772-8528
Application Fees - 49 Pa. Code §§ 15.12, 15.57.	Fall 1999, as final.	The regulation revises the Board's schedule of fees to reflect the actual costs of the services provided. Section 5 of the Law, 63 P. S. § 905, requires the Board to adopt fees by regulation to match Board revenues with expenditures.	

<i>Regulation Being Considered</i>	<i>Proposed Date for Promulgation</i>	<i>Need and Legal Basis for Action</i>	<i>Agency Contact</i>
State Board of Medicine - Sexual Misconduct - 49 Pa. Code, Chapter 16.	August 1999, as proposed.	Through the monitoring of its disciplinary process, including consumer complaints and disciplinary actions, the Board believes that enforcement standards are needed to notify licensees of acts which the Board deems unprofessional. The Board has authority to adopt regulations necessary to carry out the act under Section 8 of the Medical Practice Act, Act of December 20, 1985, P. L. 457, as amended, 63 P. S. § 422.8.	Cindy Warner (717) 783-1400
Certified Registered Nurse Practitioners (CRNPs) - 49 Pa. Code § 18.21.	September 1999, as proposed.	The Board will collaborate with the State Board of Nursing for joint promulgation of standards and criteria by which CRNPs could write prescriptions for medical therapeutic measures. Prescriptive authority of the CRNP is provided under Section 15 of the Medical Practice Act, 63 P. S. § 422.15.	
General Delegation - 49 Pa. Code, Ch. 16.	October 1999, as proposed.	This regulation would establish standards for the delegation of medical services to qualified personnel. Statutory authority: Section 17(b) of the Medical Practice Act, 63 P. S. § 422.17(b).	
Fees - 49 Pa. Code §§ 16.13, 16.17, 18.303.	September 1999, as proposed.	The regulation revises the Board's schedule of fees to reflect the actual costs of the services provided. The Board has authority to adopt such regulation under Section 6 of the Medical Practice Act, 63 P. S. § 422.6.	
Health Care Services Malpractice Act - 49 Pa. Code § 16.32.	October 1999, as final.	The General Assembly amended the Health Care Services Malpractice Act to increase malpractice insurance coverage requirements. The Board's regulations are out of date regarding these amounts. The Board plans to delete the duplication of the statutory dollar amounts and instead provide reference to the statute. Statutory authority: 40 P. S. §§ 1301.101-1301.1006.	
State Board of Vehicle Manufacturers, Dealers and Salespersons - General Provisions, Licensure, Facility requirements - 49 Pa. Code §§ 19.1-19.23.	October 1999, as proposed.	The Board will revise its regulations to repeal outdated provisions and take into account industry-wide changes in business practices. The amendments are needed to conform to the 1996 amendments to the Board of Vehicles Act. The Board has authority to promulgate regulations under Section 4(9) of the Board of Vehicles Act, Act of December 22, 1983, as amended, 63 P. S. § 818.4(9).	Teresa Woodall (717) 783-1697
Verification/Certification Fees - 49 Pa. Code § 19.4.	August 1999, as proposed.	This regulation apportions costs of providing Board services to specific applicants and licensees, pursuant to Section 30 of the Board of Vehicles Act, 63 P. S. § 818.30.	

<i>Regulation Being Considered</i>	<i>Proposed Date for Promulgation</i>	<i>Need and Legal Basis for Action</i>	<i>Agency Contact</i>
State Board of Nursing - Requirements for approval of educational programs for Certified Registered Nurse Practitioners (CRNP) - 49 Pa. Code § 21.271.	October 1999, as proposed.	This regulation would require that all CRNP programs applying for approval by the Board meet specific criteria prior to approval. The regulations authorized under Section 6.1 of the Professional Nursing Law, 63 P. S. § 216.1, will assist educational institutions in developing programs in advanced practice nursing which will qualify graduates for certification as CRNPs. The Board has authority to jointly promulgate with the Medical Board under Section 2(1) of the Law, 63 P. S. § 212(1).	Ann Steffanic (717) 783-7142
RN general revisions - 49 Pa. Code §§ 21.1 - 21.126.	Summer 1999, as proposed.	These regulations will update or repeal outdated provisions pertaining to registered nurses and consolidate all regulatory provisions pertaining to registered nurse education programs. Revisions to the regulations are authorized by Section 2.1(k) of the Professional Nursing Law, 63 P. S. § 212.1(k).	
LPN general revisions - 49 Pa. Code §§ 21.141 - 21.234.	Summer 1999, as proposed.	These regulations will update or repeal outdated provisions pertaining to licensed practical nurses and consolidate all regulatory provisions pertaining to practical nurse education programs. Revisions to the Practical Nurse Law are authorized under Section 17.6, 63 P. S. § 667.6.	
Application Fees - 49 Pa. Code §§ 21.5, 21.147, and 21.1253.	Fall 1999, as final.	The regulation revises the Board's schedule of fees to reflect the actual costs of the services provided. These regulations are authorized under Section 11.2 of the Professional Nursing Law, 63 P. S. § 221.2, and Section 7.5 of the Practical Nurse Law, 63 P. S. § 667.5.	
CRNP prescriptive privileges - 49 Pa. Code §§ 21.151 - 21.351.	September 1999, as proposed.	These regulations, to be promulgated by both the State Board of Medicine and the State Board of Nursing, would authorize CRNPs to prescribe medications in cooperation with a licensed physician. These regulations, authorized under Sections 2 and 2.1 under the Professional Nursing Law, 63 P. S. §§ 212 and 212.1(k), and Section 15 of the Medical Practice Act of 1985, 63 P. S. § 422.15, will clarify and update current, ambiguous provisions regarding CRNPs' prescriptive authority.	
Sexual Misconduct - 49 Pa. Code §§ 21.18 and 21.148.	Fall 1999, as final.	Through the monitoring of its disciplinary process, including consumer complaints and disciplinary actions, the Board believes that enforcement standards are needed to notify licensees of acts which the Board deems unprofessional. The Board has authority to adopt regulations necessary to carry out the act under Section 2.1(k) of the Professional Nursing Law, 63 P. S. § 212.1(k).	

<i>Regulation Being Considered</i>	<i>Proposed Date for Promulgation</i>	<i>Need and Legal Basis for Action</i>	<i>Agency Contact</i>
State Board of Optometry - Sexual Misconduct - 49 Pa. Code, Chapter 23.  Application Fees - 49 Pa. Code § 23.91.	No publication anticipated in next six months.  Fall 1999, as final.	Through the monitoring of its disciplinary process, including consumer complaints and disciplinary actions, the Board believes that enforcement standards are needed to notify licensees of acts which the Board deems unprofessional. The Board has authority to adopt regulations necessary to carry out the act under Section 3(a)(14) of the Optometric Practice and Licensure Act, Act of June 6, 1980, P. L. 197, as amended, 63 P. S. § 244.3(a)(14).1  The amendments apportion costs of providing services to specific applicants and licensees instead of imposing those costs on the general licensee population through biennial renewal fees. Sections 3(b)(14), 5(b) and 9 of the Optometric Practice and Licensure Act, 63 P. S. §§ 244.3(b)(14), 244.5(b) and 244.9, require the Board to set fees by regulation to match Board revenues with expenditures.	Deb Smith (717) 783-7155
State Board of Osteopathic Medicine - Sexual Misconduct - 49 Pa. Code, Chapter 25.  Application Fees - 49 Pa. Code §§ 25.231 and 25.503.	Fall 1999, as proposed.  Fall 1999, as final.	Through the monitoring of its disciplinary process, including consumer complaints and disciplinary actions, the Board believes that enforcement standards are needed to notify licensees of acts which the Board deems unprofessional. The Board has authority to adopt regulations necessary to carry out the act under Section 16 of the Osteopathic Medical Practice Act, 63 P. S. § 271.16.  These regulations will update fees for non-renewal services. These regulations are authorized under Sections 13.1(a) of the Act, 63 P. S. § 271.13(a)(a).	Gina Bittner (717) 783-4858
State Board of Pharmacy - Application Fees - 49 Pa. Code § 27.91.	Fall 1999, as final.	These regulations will update fees for non-renewal services. Statutory Authority: 63 P. S. § 390-8.2.	Rita T. Solie (717) 783-7156
State Board of Podiatry - Sexual Misconduct - 49 Pa. Code, Chapter 29.  Application Fees - 49 Pa. Code, Chapter 29.	September 1999, as proposed.  Fall 1999, as proposed.	Through the monitoring of its disciplinary process, including consumer complaints and disciplinary actions, the Board believes that enforcement standards are needed to notify licensees of acts which the Board deems unprofessional. The Board has authority to adopt regulations necessary to carry out the act under Section 16(a)(3) of the Podiatry Practice Act, Act of March 2, 1956, P. L. (1955) 1206, 63 P. S. § 42.16(a)(3).  This regulation apportions costs of providing Board services to specific applicants and licensees Statutory authority: 63 P. S. § 42.15.	Gina Bittner (717) 783-4858



<i>Regulation Being Considered</i>	<i>Proposed Date for Promulgation</i>	<i>Need and Legal Basis for Action</i>	<i>Agency Contact</i>
State Board of Veterinary Medicine - Advertising Emergency Services - 49 Pa. Code § 31.21.	January 2000, as final.	The regulation will require all veterinarians who advertise emergency services or 24-hour veterinary care, to include in any advertisement information indicating the hours when emergency services are available, and whether a veterinarian will be on call or on the premises. Statutory authority: 63 P. S. § 485.5(2).	Robert Kline (717) 783-1389
Verification/Certification Fees - 49 Pa. Code § 31.41.	Fall 1999, as final.	This regulation apportions costs of providing Board services to specific applicants and licensees. Section 13 of the Veterinary Practice Act, 63 P. S. § 485.13.	
State Board of Dentistry - Sexual Misconduct - 49 Pa. Code, Chapter 33.	June 2000, as proposed.	Reports of sexual misconduct by health care practitioners are on the rise. This regulation will provide licensees with guidance in this area, as authorized under Section 3(o) of the Dental Law, 63 P. S. § 122(o).	Rita T. Solie (717) 783-7162
Advertising - 49 Pa. Code § 33.203(b)(4).	June 2000, as proposed.	The regulation will amend outdated provisions, clarify dental specialties and add a provision regarding the advertising of dental referral services. Section 4.1(a)(10) of the Dental Law prohibits false, misleading or deceptive advertising. The Board believes that the failure to advise patients that a dentist pays a fee for participation in a dental referral service falls within that prohibition and should be included in Section 33.203(b) of the regulations. The regulation will also update this provision consistent with Act 113 of 1996.	
Expanded Function Dental Assistants - 49 Pa. Code, Chapter 33.	Fall 1999, as final.	The regulations will establish certification standards for expanded function dental assistants including minimum standards of conduct and practice, under 1994 amendments to the Dental Law. Statutory authority: Section 3(o) of the Dental Law, 63 P. S. § 122(o).	
Continuing Professional Education - 49 Pa. Code, Chapter 33.	July 1999, as final.	This regulation will establish continuing education regulations for dentists, dental hygienists and expanded function dental assistants. The regulations are required under Act 113 of 1996, which amended Section 3(j) of the Dental Law, 63 P. S. § 122(j).	
Lasers - 49 Pa. Code, Chapter 33.	June 2000, as proposed.	The regulation will codify the existing statement of policy and clarify educational requirements for the use of lasers in a dental office. Statutory authority: Section 3(o) of the Dental Law, 63 P. S. § 122(o).	
Verification/Certification Fees - 49 Pa. Code § 33.3.	Fall 1999, as final.	This regulation apportions costs of providing Board services to specific applicants and licensees. Statutory authority: Section 4 of the Dental Law, 63 P. S. § 123.	

<i>Regulation Being Considered</i>	<i>Proposed Date for Promulgation</i>	<i>Need and Legal Basis for Action</i>	<i>Agency Contact</i>
State Real Estate Commission - General Revisions - 49 Pa. Code, Chapter 35.	Winter 2000, as final.	The Commission plans a comprehensive amendment to Chapter 35 to bring existing regulations up to date with current policies. Statutory authority: 63 P. S. § 455.404.	Debra Sopko (717) 783-3658
Educational Standards - 49 Pa. Code, Chapter 35.	Spring 2000, as proposed.	The Commission plans to update current rules pertaining to the approval of schools and school directors, curriculum, etc. and revise continuing education requirements. Statutory authority: 63 P. S. § 455.404.	
Continuing Education Deadline- 49 Pa. Code, Chapter 35.	Fall 1999, as proposed.	The Commission plans to amend current rules pertaining to continuing education deadlines. Statutory authority: 63 P. S. § 455.404.	
Agency Disclosures - 49 Pa. Code, Chapter 35.	Summer 1999, as proposed; November 1999, as final.	This regulation will implement disclosure requirements of Act 112 of 1998 pertaining to agency relationships in compliance with the statutory deadline. Statutory authority: 63 P. S. § 455.404.	
Application Fees - 49 Pa. Code § 35.203.	Fall 1999, as proposed.	This regulation apportions costs of providing Board services to specific applicants and licensees. The Board is authorized to determine all fees necessary for administration of the act under Section 407(a) of the Real Estate Licensing and Registration Act, 63 P. S. § 455.407(a).	
State Board of Certified Real Estate Appraisers - Experience Options for Certification, Duties of Supervising Appraiser - 49 Pa. Code §§ 36.13 and 36.14.	Summer 1999, as proposed.	The regulations revise qualifying experience for certification as an appraiser; impose supervisory and record-keeping duties on appraisers who supervise appraisal assistants; and require appraisal reports submitted as qualifying experience to conform to the Uniform Standards of Professional Appraisal Practice (USPAP). The regulations are consistent with standards established for state appraiser boards by the federal Appraiser qualification Board (AQB). Statutory authority: 63 P. S. § 457.5(2).	Cheryl Lyne (717) 783-3397
Standards of Practice - 49 Pa. Code § 36.51.	Summer 1999, as proposed.	The regulations require all certified general appraisers, residential appraisers and broker/appraisers to comply with the USPAP unless the Board has adopted supplemental practice standards. The regulations also would require all appraisers, when performing an appraisal, to conduct a complete interior and exterior inspection of the subject property unless an interior inspection is not feasible or physically possible. Statutory authority: 63 P. S. § 457.5(2).	
Pre-Certification Education and Experience - 49 Pa. Code §§ 36.11 and 36.12.	Summer 1999, as proposed.	The regulations raise the experience and education requirements for certification as a residential appraiser and general appraiser to mirror AQB standards that became effective in Pennsylvania, by operation of law, on January 1, 1998. Statutory authority: 63 P. S. § 457.5(2).	
Fees - 49 Pa. Code § 36.6.	Summer 1999, as proposed.	The regulation revises the Board's schedule of fees to reflect the actual costs of the services provided. Statutory authority: 63 P. S. § 457.9.	

<i>Regulation Being Considered</i>	<i>Proposed Date for Promulgation</i>	<i>Need and Legal Basis for Action</i>	<i>Agency Contact</i>
State Registration Board for Professional Engineers, Land Surveyors and Geologists - Certification/Verification Fees - 49 Pa. Code § 37.17.	Fall 1999, as final.	The regulation apportions costs of providing Board services to specific applicants and licensees. Statutory authority: Section 9 of the Engineer, Land Surveyor and Geologist Registration Act, as amended, 63 P. S. § 156.	Shirley Klinger (717) 783-3397
State Board of Examiners of Nursing Home Administrators - Temporary Permits - 49 Pa. Code § 39.17.	Fall 1999, as proposed.	The regulation will update and clarify Board requirements for temporary permits. Statutory authority: Section 14 of the Nursing Home Administrators License Act, 63 P. S. § 1114.	Melissa Wilson (717) 783-7155
Continuing Education - 49 Pa. Code §§ 39.31-39.71.	Fall 1999, as final.	The regulation will amend and clarify the continuing education requirement in Section 9 of the Nursing Home Administrators License Act, 63 P. S. § 1109.	
Application/Certification/Verification Fees - 49 Pa. Code § 39.72.	Fall 1999, as final.	This regulation apportions costs of providing Board services to specific applicants and licensees. Statutory authority: Section 7.1 of the Law, 63 P. S. § 1108.	
State Board of Physical Therapy - Physical Therapists - 49 Pa. Code §§ 40.11, 40.13, 40.15, 40.17, 40.18 and 40.21-40.24.	Fall 1999, as proposed.	Regulations correct and revise existing regulations regarding physical therapists. Proposed under Section 3(a) of the Physical Therapy Practice Act, 63 P. S. § 1303(a).	Robert Kline (717) 783-7134
Sexual Misconduct - 49 Pa. Code, Chapter 40.	Fall 1999, as proposed.	Through the monitoring of its disciplinary process, including consumer complaints and disciplinary actions, the Board believes that enforcement standards are needed to notify licensees of acts which the Board deems unprofessional. The Board has authority to adopt regulations necessary to carry out the act under Sections 3, 5 and 10 of the Act, 63 P. S. § 1303, 1305 and 1310.	
Application/Verification/Certification Fees - 49 Pa. Code § 40.5.	Fall 1999, as final.	This regulation apportions costs of providing Board services to specific applicants and licensees. Statutory authority: 63 P. S. § 1308.	
State Board of Psychology - Post-Doctoral Experience - 49 Pa. Code § 41.31(c)(1)(ii)(E).	Winter 1999, as proposed.	The regulation establishes necessary experience for licensure. The Board plans to clarify its intent that an individual working two jobs need only meet with his/her respective supervisors one hour per week to satisfy the two-hours/week requirement of this paragraph. Statutory authority: 63 P. S. § 1203.2(2).	Melissa Wilson (717) 783-7155
Definitions/ "Sexual Intimacies" - 49 Pa. Code § 41.61.	Fall 1999, as final.	The regulation will establish specific prohibitions against sexual intimacies with current client/patients and other individuals encountered by a psychologist in the course of professional practice. The regulation will also establish related standards and procedural matters and bar psychologists who have been disciplined for engaging in prohibited sexual intimacies from participation in the impaired professional program. Statutory authority: 63 P. S. § 1203.2(2).	
Application/Certification/Verification Fees - 49 Pa. Code § 41.12.	Fall 1999, as final.	This regulation apportions costs of providing Board services to specific applicants and licensees. The Board is authorized to determine all fees necessary for administration of the act under 63 P. S. § 1203.2(2).	

<i>Regulation Being Considered</i>	<i>Proposed Date for Promulgation</i>	<i>Need and Legal Basis for Action</i>	<i>Agency Contact</i>
State Board of Occupational Therapy Education and Licensure - Oral Orders - 49 Pa. Code § 42.25.	Summer 1999, as proposed.	The Board proposes to specify circumstances under which occupational therapists may accept oral orders for services, and procedures to be followed, to clarify for Department of Health-licensed health care facilities that occupational therapists, under Department rules, are "...authorized by appropriate statutes and the State Board in the Bureau of Professional and Occupational Affairs" to receive such orders. Statutory authority: Sections 5(b) and 14 of the Occupational Therapy Practice Act, 63 P. S. §§ 1505(b) and 1514.	Clara Flinchum (717) 783-1389
General Revisions - 49 Pa. Code, Chapter 42.	Fall 1999, as proposed.	The Board proposes to revise its chapter by updating certain provisions and deleting outdated or redundant language. The Board has authority to adopt the regulations necessary to perform its duties and for the proper administration of the law under Section 5(b) of the Occupational Therapy Practice Act, 63 P. S. § 1505(b).	
Verification/Certification Fees - 49 Pa. Code § 42.17(a)(4).	Fall 1999, as final.	This regulation apportions costs of providing Board services to specific applicants and licensees. The Board is authorized to determine all fees necessary for administration of the act under Section 17(a) of the Occupational Therapy Practice Act, 63 P. S. § 1517(a).	
State Board of Examiners in Speech-Language and Hearing - Assistants - 49 Pa. Code, Chapter 45.	January 2000, as proposed.	The proposal will bring current regulations into compliance with current national standards, by modifying requirements for supervision of assistants. Statutory authority: 63 P. S. § 1705(2).	Clara Flinchum (717) 783-1389
Oral Orders - 49 Pa. Code § 45.10.	January 2000, as proposed.	The proposal will authorize acceptance of oral orders by licensed professionals in long term care facilities. Statutory authority: 63 P. S. § 1705(2).	
<b>STATE EMPLOYEES' RETIREMENT SYSTEM</b>			
No regulations being developed or considered at this date.			

<i>Regulation Being Considered</i>	<i>Proposed Date for Promulgation</i>	<i>Need and Legal Basis for Action</i>	<i>Agency Contact</i>
<b>STATE POLICE</b>			
Firearm Regulations Standards for licensed retail dealers Chapter 31	October 1999, as final.	The provisions of this chapter set forth regulations for the storage of firearms, rifles, and shotguns by licensed retail dealers in the event a clear and present danger to public safety is found to exist by the Commissioner of the State Police within this Commonwealth during the hours when licensed retail dealers are closed for business. The provisions of this chapter apply to all licensed retail dealers and their designated employees.	Ronald E. Plesco 717-772-0905
Procedures & Specifications for firearm record forms Chapter 33	October 1999, as final.	The regulations provide for the administration of the provisions of the Uniform Firearms Act for the implementation of the Pennsylvania Instant Check System (PICS) in order to approve or deny the sale or transfer of firearms and licenses to carry a firearm in accordance with the provisions of the UFA. The regulations also ensure the identity, confidentiality, and security of all information collected and disseminated by the PICS in accordance with the UFA.	
Regulatory amendments to clarify various aspects of the Municipal Police Officers' Education and Training Commission regulations, Chapter 203	August 1999, as final.	The provisions of this chapter set forth regulations for the administration of the training program for municipal police by the Municipal Police Officers' Education and Training Commission. The proposed amendments correct various aspects of existing regulations and suspend the vision standard until disposition of pending litigation.	Major Richard Mooney 717-533-5987
<b>STATE SYSTEM OF HIGHER EDUCATION</b>			
No regulations being developed or considered at this date.			
<b>TRANSPORTATION</b>			
Manufacturer, Dealers and Miscellaneous Motor Vehicle Businesses Registration Plates Chapter 53	April 2000, as proposed.	Amendments are needed based on revisions to related sections of the Vehicle Code and Industry/Department concerns. Proposed package with the Department's Legal Counsel.	Sue Wilson (717) 787-4291
60 - Permanent Registration of Fleet Vehicles	September 1999, as proposed.	Proposed amendments required to modify fee schedules associated with House Bill 67 (Act 3 of 1997).	John Munafo (717)787-3977
School Buses and School Vehicles Chapter 171	April, 2000, as proposed.	Amendments are needed to clarify previous revisions and to address concerns raised by the School Bus Vehicle Industry and related Associations. The Department has prepared draft amendments based on recommendations received by various associations. Proposed Regulatory package final draft to be reviewed by Legal Counsel and revisions are being incorporated.	Mike Kistler (717) 783-4534
Physical and Mental Criteria, Including Vision Standards Relating to the Licensing of Drivers Chapter 83	April 2000, as proposed.	As a result of a Pa Supreme Court decision (Clayton v.s. Department of Transportation), additional waivers to seizure disorder provisions must be adopted. The Department's Medical Advisory Board is in the process of approving proposed amendments.	Mike Kistler (717) 783-4534

<i>Regulation Being Considered</i>	<i>Proposed Date for Promulgation</i>	<i>Need and Legal Basis for Action</i>	<i>Agency Contact</i>
Liquid Fuels Tax Chapter 449	October 1999, as proposed.	Regulatory review committee has been formed. Drafts of that result have been discussed with legal counsel. Regulations submitted to legal for review and submission to IRRC, June 1, 1999.	Dick Zerbe (717) 787-2183
School Bus Drivers Chapter 71	April 2000, as proposed.	Creates waivers for school bus drivers, with medical conditions, who pose no significant danger to driving. The Department's Medical Advisory will be approving amendments to incorporate recommendations being developed by the Insulin Dependent Diabetes Task Force.	Mike Kistler (717) 783-4534
Work Zone Traffic Control Devices Chapter 203	December 1999, as proposed deletion.	Repeal this chapter since it typically is more stringent than federal standards included in the Federal Highway Administration's Manual on Uniform Traffic Control Devices (MUTCD). Some current provisions not included in the MUTCD would be incorporated into Chapter 211.	Art Breneman (717) 787-3620
Official Traffic Control Devices Chapter 211	December, 1999, as proposed.	Repeal the current chapter since it duplicates federal standards included in the Federal Highway Administration's Manual on Uniform Traffic Control Devices (MUTCD). Adopt the MUTCD by reference, and provide some additional criteria unique to the Commonwealth.	Art Breneman (717) 787-3620
Hold-Down and Tie-Down Devices for Junked Vehicles and Vehicle Hulks—Chapter 181	December 1999, as proposed.	Repeal - incorporate provisions in Chapter 231	Daniel Smyser (717) 787-7445
Engineering and Traffic Studies Chapter 201	December, 1999, as proposed deletion.	Repeal this chapter since it typically is more stringent than federal standards included in the Federal Highway Administration's Manual on Uniform Traffic Control Devices (MUTCD). Some current provisions not included in the MUTCD would be incorporated into Chapter 211.	Art Breneman (717) 787-3620
Intrastate Motor Carrier Safety Requirements Chapter 231	December 1999, as proposed.	Incorporate new Federal provisions, and provisions from Chapter 181.	Daniel Smyser (717) 787-7445
Hazardous Materials Transportation Chapter 403	December 1999, as proposed.	Incorporate new Federal provisions and eliminate registration requirement.	Daniel Smyser (717) 787-7445
Airport Rating Licensing - Chapter 471	August 1999, as proposed.	Amendment is needed to correct inconsistencies between Federal and State requirements and to correct inconsistencies within the regulation itself. It is necessary to more clearly define the requirements and to react to the operating environment.	Kathy Reiz (717) 705-1234
Proportional Registration of Fleet Vehicles Chapter 63	September 1999, as proposed.	Proposed amendments required to modify fee schedules associated with House Bill 67 (Act 3 of 1997).	John Munafo (717) 787-3977
Vehicle Equipment and Inspection Chapter 175	March 2000, as final.	Proposed amendments required to comply with Act 151 of 1998.	Tom Zamboni (717) 783-9513

<i>Regulation Being Considered</i>	<i>Proposed Date for Promulgation</i>	<i>Need and Legal Basis for Action</i>	<i>Agency Contact</i>
Vehicle Equipment and Inspection Chapter 175	April 2000, as proposed.	Proposed amendments require complying with Act 115 of July 6, 1995. No. 30, P. L. 246 that requires the establishment of equipment and inspection criterion for farm vehicles with a gross weight rating greater than 17,000 pounds.	Tom Zamboni (717) 783-9513
Flashing or Revolving Lights on Emergency and Authorized Vehicles Chapter 173	March 2000, as final.	Proposed amendments required to comply with Act 151 of 1998.	Tom Zamboni (717) 783-9513
Temporary Registration Cards and Plates Chapter 43	Sept. 1999, as proposed.	Proposed amendments would address changes needed in the Temporary Plate Issuance Program so as to reduce fraud and improve the accuracy of registration data.	Randy Swartz (717) 787-2780
Authorization to Verify VIN Identification Numbers Chapter 17	June 2000, as proposed.	Proposed amendments would authorize department employees to verify VIN Numbers for vehicles requiring a Certificate of Title.	Tom Zamboni (717) 783-9513
Emission Inspection Chapter 177	November 1999, as final.	Modification of Enhanced I/M Inspection Program into additional counties. Presently under development by Chief Counsel's Office.	Peter Gertz (717) 783-7016
Emission Inspection Chapter 177	June 2000, as proposed.	Amendments needed to address ongoing operational aspects of the emissions program.	Peter Gertz (717) 783-7016
Financial Responsibility Obligations of Insurance Companies and Vehicle Owners Chapter 221	April 2000, as proposed.	Amend regulation to change the method by which the Department determines that insurance has been cancelled/terminated and information verified by PennDOT.	Richard Bettinger (717) 787-7767
Consultant Highway Design Errors Chapter 455	December 1999, as proposed deletion.	Since there is no legal need for this chapter, the Department proposes to delete Chapter 455 and propose a Department policy to address consultant design errors.	Charles Allwein (717) 783-9309

[Pa.B. Doc. No. 99-1064. Filed for public inspection July 2, 1999, 9:00 a.m.]

## HEALTH CARE COST CONTAINMENT COUNCIL

### Meeting Dates

The Health Care Cost Containment Council has scheduled the following meetings for July: Wednesday, July 7, 1999, Data Systems Committee at 10 a.m.; Education Committee 1:30 p.m. Thursday, July 8, 1999, Council Meeting at 10 a.m. The meetings will be held in the Council's Conference Room at 225 Market Street, Suite 400, Harrisburg, PA. The public is invited to attend. Persons who need accommodation due to a disability and want to attend the meetings, should contact Cherie Elias, Health Care Cost Containment Council, 225 Market Street, Suite 400, Harrisburg, PA 17101, or call (717) 232-6787, at least 24 hours in advance so that arrangements can be made.

MARC P. VOLAVKA,  
*Executive Director*

[Pa.B. Doc. No. 99-1065. Filed for public inspection July 2, 1999, 9:00 a.m.]

## INDEPENDENT REGULATORY REVIEW COMMISSION

### Actions Taken by the Commission

The Independent Regulatory Review Commission met publicly at 10:30 a.m., Thursday, June 17, 1999, and took the following actions:

#### *Regulations Approved:*

Environmental Quality Board #7-310: Water Quality Amendments-Antidegradation (amends 25 Pa. Code Chapters 93 and 95).

#### *Regulations Disapproved:*

State Board of Education #6-258: Certification of Professional Personnel (amends Subchapters A, B, and C of 49 Pa. Code).

Lobbying Disclosure Committee #63-06: Lobbying Disclosure (amends 51 Pa. Code by adding Chapters 31—45).

*Commissioners Present:* John R. McGinley, Jr., Chairperson; Alvin C. Bush, Vice Chairperson; Arthur Cocodrilli—dissenting; Robert J. Harbison, III; John F. Mizner

Public Meeting held  
June 17, 1999

*Environmental Quality Board—Water Quality Amendments—Antidegradation; Regulation No. 7-310*

#### Order

On March 10, 1997, the Independent Regulatory Review Commission (Commission) received this proposed regulation from the Environmental Quality Board (EQB). This rulemaking amends 25 Pa. Code Chapters 93 and 95. The authority for this regulation is contained in section 1920-A of The Administrative Code of 1929 (71 P. S. § 510-20) and section 5(b)(1) of The Clean Streams Law (35 P. S. § 691.5(b)(1)). The proposed regulation was published in the *Pennsylvania Bulletin* with a 60-day public comment period. The Department of Environmental Protection (DEP) published an advance notice of final rulemaking (ANFR) in the January 23, 1999 *Pennsylvania Bulletin* with a 30-day public comment period. The final-form regulation was submitted to the Commission on May 20, 1999.

This regulation is a response to the 1994 disapproval of the Commonwealth's antidegradation program by the United States Environmental Protection Agency (EPA). The regulation addresses concerns raised by EPA's disapproval. It is intended to bring Pennsylvania's water quality standards into greater consistency with the Federal program.

The EPA published final regulations effective January 8, 1997, for Pennsylvania's antidegradation program. This regulation will replace EPA's regulations for Pennsylvania. The regulation establishes a framework for designating streams for special protection. In order to receive special protection, streams must be examined for their chemical or biological characteristics.

We have reviewed this regulation and find it to be in the public interest. The regulation is necessary to adequately protect unique and high quality streams in the Commonwealth.

*Therefore, It Is Ordered That:*

1. Regulation No. 7-310 from the Environmental Quality Board, as submitted to the Commission on May 20, 1999, is approved; and

2. The Commission will transmit a copy of this Order to the Legislative Reference Bureau.

*Commissioners Present:* John R. McGinley, Jr., Chairperson; Alvin C. Bush, Vice Chairperson; Arthur Cocodrilli; Robert J. Harbison, III; John F. Mizner

Public Meeting held  
June 17, 1999

*State Board of Education— Certification of Professional Personnel; Regulation No. 6-258*

#### Order

On April 9, 1997, the Independent Regulatory Review Commission received this proposed regulation from the State Board of Education. This rulemaking amends Subchapters A, B, and C of 22 Pa. Code Chapter 49. The authority for this regulation is sections 1201—1268, 1109, 1141, 2603-B and 2604-b of the Public School Code (24

P. S. §§ 12-1201—12-1268, 11-1109, 11-1141, 26-2603-B and 26-2604-B). The proposed regulation was published in the April 19, 1997 *Pennsylvania Bulletin* with a 30-day public comment period. The final-form regulation was submitted to the Commission on May 17, 1999.

This regulation is the result of the Board's decennial review of certification rules and procedures. In response to comments from the Standing Committees, the public and the Commission, the Board made several major amendments to the final-form regulation. The Board removed controversial provisions for alternate entry, temporary waivers and professional development. The final-form regulation will add Program and Certificate principles, improve the assessment program for certification and collapse two levels of supervisory and administrative certificates into one level.

We have reviewed this regulation and have found that it is not in the public interest. We have two concerns with the final-form regulation. First, the provisions relating to the establishment of certification standards are not within the Board's statutory authority. Second, the Educational Specialist II certificate requirements do not meet the criteria of clarity and reasonableness.

Our first concern relates to the Board's delegation, in Subchapter B, of the authority to establish standards for individual certification to the Department of Education. In the proposed rulemaking, the Board amended the requirements for instructional certificates, educational specialist certificates, supervisory certificates and administrative certificates (Sections 49.81(b), 49.101, 49.111(a)(5) and 49.121(d)). The amendments are similar in that they provide that state certificates will be issued to candidates "...who meet *Department prescribed standards based on the following principles:*" (Emphasis added.)

Under the Public School Code and miscellaneous education laws, the authority to establish standards for certification resides solely with the Board. The Board's overall authority in this area is set forth in the Public School Code, 24 P. S. § 26-2606-B (Cooperation between the Board and the Department of Education), which provides:

Statements of policy, standards, rules and regulations promulgated by the board shall be binding upon the Department of Education. The department *shall submit to the board for approval, modification or rejection*, all rules and regulations proposed by the department in the areas under control of the board. The Department of Education shall furnish upon request of the board such data and information as the board may, from time to time, require, and the department shall provide administrative services for and on behalf of the board for the implementation of the board's statements of policy, standards, rules and regulations. [Emphasis added]

This section must be read in pari materia with Miscellaneous Laws, 24 P. S. § 1226 (Powers and duties of the State Board of Education). This section provides, in part:

The State Board of Education *shall have the power, and its duty shall be—*

\* \* \* \* \*

(b) *To establish and promulgate standards of preliminary and professional education and training for teachers in such schools.* [Emphasis added]

Finally, 24 P. S. § 2070.2. (Certification requirements) provides:



No person shall teach in a public school in the Commonwealth unless he has met the *certification requirements as established by the State Board of Education* which are applicable to the institution where he is employed. [Emphasis added]

While the Board states it approves certification standards as a matter of practice, there is no obligation, in the regulation, for the Board to approve the Department's prescribed standards. To meet its statutory requirements and the criteria of clarity, the regulation should require the Board to approve the standards for each certificate developed by the Department.

Our second concern relates to Educational Specialist Certificates. The existing regulation requires an applicant for an Educational Specialist II certificate to "have completed 3 years of satisfactory *service* on a Level I Educational Specialist Certificate." (Emphasis added.) This section recognizes that some educational specialists do not teach.

In the proposed regulation, Section 49.103(2) altered this requirement by requiring an applicant to "have completed 3 years of satisfactory *teaching* on an Educational Specialist I Certificate." (Emphasis added.) We recommended that the Board delete the requirement for *teaching* and continue the existing requirement for *service* in this provision.

The Board did not respond to our comment on this issue. Section 49.103(2) of the final-form regulation would require 3 years of satisfactory teaching. As drafted, Section 49.103(2) of the final-form regulation does not meet the criteria of clarity and reasonableness.

*Therefore, It Is Ordered That:*

1. Regulation No. 6-258 from the State Board of Education, as submitted to the Commission on May 17, 1999, is disapproved;

2. The State Board of Education shall, within seven days of receipt of this Order, notify the Governor, the designated Standing Committees of the House of Representatives and the Senate, and the Commission of its intention to either proceed with the promulgation of the regulation without revisions, to revise the regulation, or to withdraw the regulation. Failure to submit notification within the 7-day period shall constitute withdrawal of the regulation;

3. The Commission will transmit a copy of this Order to the Legislative Reference Bureau; and

4. This Order constitutes a bar to final publication of Regulation No. 6-258 under section 6(b) of the Regulatory Review Act.

*Commissioners Present:* John R. McGinley, Jr., Chairperson; Alvin C. Bush, Vice Chairperson; Arthur Cocodrilli; Robert J. Harbison, III; John F. Mizner

Public Meeting held  
June 17, 1999

*Lobbying Disclosure Committee—Lobbying Disclosure; Regulation No. 63-6*

**Order**

On January 20, 1999, the Independent Regulatory Review Commission (Commission) received this proposed regulation from the Lobbying Disclosure Committee (LDC). This rulemaking amends 51 Pa. Code by adding Chapters 31—45. The authority for this regulation is contained in sections 1305(b)(3)(iii) and 1310(c) of the

Lobbying Disclosure Act (Act) (65 Pa.C.S. §§ 1305(b)(3)(iii) and 1310(c)). The proposed regulation was published in the January 30, 1999 *Pennsylvania Bulletin* with a 30-day public comment period. The final-form regulation was submitted to the Commission on May 26, 1999.

This regulation is being promulgated to implement the Act. The proposed regulations, like the Act, outline what constitutes lobbying, who must register, what must be reported, and auditing and enforcement procedures.

Comments were filed on this final-form regulation by: Senators Brightbill, Mellow and Lemmond, the members of the subcommittee established by the Rules and Executive Nominations Committee; Stephen C. MacNett, General Counsel for the Senate Majority Caucus; and the Pennsylvania Association for Government Relations. On June 15, 1999, the House Judiciary Committee voted to disapprove the final-form regulation.

We have reviewed this regulation and find it not to be in the public interest. While the majority of this rulemaking tracks the language and intent of the Act, there are two areas where the regulation exceeds the authority granted by the Act.

First, in this proposal the LDC has created a new term, "de minimis" which is defined as "insignificant." This term does not appear in the Act. However, it is used in the definition of "lobbyist" and in section 35.1(g)(6) which establishes reporting requirements for principals.

The statutory definition of "lobbyist" does not contain a de minimis exemption. Under the Act, a lobbyist is someone who "engages in lobbying on behalf of a principal for economic consideration." Furthermore, section 1306(3) of the Act contains the only statutory exclusions from registration and reporting. It includes the following:

(II) An individual whose compensation for lobbying, from all principals represented, does not exceed \$2500 *in the aggregate* during any reporting period.

\* \* \* \* \*

(IV) A principal *whose total expenses* for lobbying purposes do not exceed \$2500 during any reporting period. (emphasis added).

There are two problems with these provisions. First, the LDC has not specified a dollar amount that would be considered de minimis. Second, clearly the Act requires lobbyists to aggregate all compensation and requires principals to total all of their lobbying expenses. There is no provision for any compensation or expenses to be considered de minimis because of the aggregating and totaling requirements of the Act.

The other area where the LDC has exceeded its statutory authority is in the provisions governing random audits. Under section 1308(g) of the Act, the Ethics Commission "shall initiate, by lottery, random annual audits of registration statements and disclosure reports. . . ." The final-form regulation, in sections 41.2(d) and (e), would allow the Ethics Commission to examine "the relevant records of any other registrant" as part of an audit of the randomly selected registrant. However, the statute does not give the Ethics Commission the authority to require a registrant, who is not the subject of an audit, to produce any records.

There are also areas which we raised in our Comments and which have been raised by the Senate that do not meet the reasonableness or clarity criteria of the Regulatory Review Act. For example, the definition of service (of

official papers) should be revised to use the postmark date, not the date of mailing. Also, inserting "related" between "other" and "practices" in section 41.4(b) and refining the language in sections 41.3(c)(2)(ii) and (3) would clarify the conduct of audits. These changes, and the other Senate suggestions offering technical changes, would enhance the clarity of the regulation.

*Therefore, It Is Ordered That:*

1. Regulation No. 63-6 from the Lobbying Disclosure Committee as submitted to the Commission on May 26, 1999, is disapproved;

2. The Lobbying Disclosure Committee shall, within 7 days of receipt of this Order, notify the Governor, the designated Standing Committees of the House of Representatives and the Senate, and the Commission of its intention to either proceed with the promulgation of the regulation without revisions, to revise the regulation, or to withdraw the regulation. Failure to submit notification within the 7-day period shall constitute withdrawal of the regulation;

3. The Commission will transmit a copy of this Order to the Legislative Reference Bureau; and

4. This Order constitutes a bar to final publication of Regulation No. 63-6 pursuant to Section 6(b) of the Regulatory Review Act.

JOHN R. MCGINLEY, Jr.  
*Chairperson*

[Pa.B. Doc. No. 99-1066. Filed for public inspection July 2, 1999, 9:00 a.m.]

## INSURANCE DEPARTMENT

### Application for Approval to Acquire Control of Calvert Insurance Company

Lumbermens Mutual Casualty Company has filed an application for approval to acquire control of Calvert Insurance Company, a Pennsylvania domiciled stock fire insurance company. The filing was made under the requirements set forth under the Insurance Holding Companies Act, 40 P.S. § 991.1402, et seq. Persons wishing to comment on the acquisition are invited to submit a written statement to the Insurance Department within 15 days from the date of this issue of the *Pennsylvania Bulletin*. Each written statement must include name, address and telephone number of the interested party, identification of the application to which the statement is addressed, and a concise statement with sufficient detail and relevant facts to inform the Insurance Department of the exact basis of the statement. Written statements should be directed to Cressinda Bybee, Company Licensing Division, Insurance Department, 1345 Strawberry Square, Harrisburg, PA 17120, or by fax to (717) 787-8557.

M. DIANE KOKEN,  
*Insurance Commissioner*

[Pa.B. Doc. No. 99-1067. Filed for public inspection July 2, 1999, 9:00 a.m.]

### Coal Mine Compensation Rating Bureau of Pennsylvania; Workers' Compensation Employer Assessment Procedures Filing

On June 11, 1999, the Insurance Department received from the Coal Mine Compensation Rating Bureau of Pennsylvania a filing to implement the final-form rules pertaining to the imposition, collection and remittance of employer assessments for special funds as defined under Act 57 of 1997. The Bureau requests an overall 0.0% change which includes loss based assessments.

Copies of the filing are available for public inspection during normal working hours, by appointment, at the Insurance Department's offices in Harrisburg, Philadelphia, Pittsburgh and Erie.

M. DIANE KOKEN,  
*Insurance Commissioner*

[Pa.B. Doc. No. 99-1068. Filed for public inspection July 2, 1999, 9:00 a.m.]

### Liberty Mutual Fire Insurance Company; Homeowners Rate Filing

On June 16, 1999, the Insurance Department received from Liberty Mutual Fire Insurance Company a filing for a proposed rate level and rule changes for homeowners insurance.

The company requests an overall 1.9% increase amounting to \$406,000 annually, to be effective August 16, 1999.

Unless formal administrative action is taken prior to August 15, 1999, the subject filing may be deemed approved by operation of law.

Copies of the filing will be available for public inspection, by appointment, during normal working hours at the Insurance Department's offices in Harrisburg, Philadelphia, Pittsburgh and Erie.

Interested parties are invited to submit written comments, suggestions or objections to Xiaofeng Lu, Insurance Department, Bureau of Regulation of Rates and Policies, Room 1311, Strawberry Square, Harrisburg, PA 17120, (E-mail: xlu@ins.state.pa.us) within 30 days after publication of this notice in the *Pennsylvania Bulletin*.

M. DIANE KOKEN,  
*Insurance Commissioner*

[Pa.B. Doc. No. 99-1069. Filed for public inspection July 2, 1999, 9:00 a.m.]

### Review Procedure Hearings; Cancellation or Refusal of Insurance

The following insureds have requested a hearing, as authorized by the act of June 17, 1998 (P. L. 464, No. 68) in connection with their company's termination of the insured's automobile policies. The hearings will be held in accordance with the requirements of the act; 1 Pa. Code Part II (relating to the General Rules of Administrative Practice and Procedure); and 31 Pa. Code §§ 56.1—56.3 (relating to Special Rules of Administrative Practice and Procedure). All administrative hearings are held in the Insurance Department Offices in Harrisburg, PA. Failure

by the appellant to appear at the scheduled hearing may result in dismissal with prejudice.

The hearings will be held in the Capitol Associates Building, 901 North Seventh Street, Second Floor Hearing Room, Harrisburg, PA 17102.

Appeal of Janet A. and Ronald W. Kimball; file no. 99-210-31872; Nationwide Mutual Insurance Company; doc. no. PH99-06-011; July 22, 1999, at 10 a.m.;

Appeal of Heather J. and Thomas King; file no. 99-494-90335; Erie Insurance Exchange; doc. no. E99-06-012; July 22, 1999, at 1 p.m.;

Appeal of Edith Benson; file no. 99-494-90343; Nationwide Insurance Co.; doc. no. E99-06-018; July 27, 1999, at 1 p.m.

Parties may appear with or without counsel and offer relevant testimony or evidence. Each party must bring documents, photographs, drawings, claims files, witnesses and the like necessary to support the party's case. A party intending to offer documents or photographs into evidence shall bring enough copies for the record and for each opposing party.

In some cases, the Commissioner may order that the company reimburse an insured for the higher cost of replacement insurance coverage obtained while the appeal is pending. Reimbursement is available only when the insured is successful on appeal, and may not be ordered in all instances. If an insured wishes to seek reimbursement for the higher cost of replacement insurance, the insured must produce documentation at the hearing which will allow comparison of coverages and costs between the original policy and the replacement policy.

Following the hearing and receipt of the stenographic transcript, the Insurance Commissioner will issue a written order resolving the factual issues presented at the hearing and stating what remedial action, if any, is required. The Commissioner's Order will be sent to those persons participating in the hearing or their designated representatives. The order of the Commissioner is subject to judicial review by the Commonwealth Court.

Persons with a disability who wish to attend the above-referenced administrative hearings, and require an auxiliary aid, service or other accommodation to participate in the hearing, should contact Tracey Pontius, Agency Coordinator at (717) 787-4298.

M. DIANE KOKEN,  
*Insurance Commissioner*

[Pa.B. Doc. No. 99-1070. Filed for public inspection July 2, 1999, 9:00 a.m.]

### Review Procedure Hearings under the Unfair Insurance Practices Act

The following insurer has requested a hearing as authorized by section 8 of the Unfair Insurance Practices Act (40 P. S. § 1171.8) in connection with the termination of the insured's policy.

The hearing will be held in the Capitol Associates Building, 901 North Seventh Street, Second Floor Hearing Room, Harrisburg, PA 17102.

Appeal of State Farm Fire and Casualty Company; file no. 99-265-31886; David and Susan Zweiback; doc. no. PH99-06-019; July 28, 1999, at 10 a.m.

Both parties may appear with or without counsel and offer relevant testimony or evidence to support their respective positions. The representative of the company must bring relevant claims files and other necessary evidence. The insured must bring all documents, photographs, drawings, witnesses and the like necessary to substantiate the case. The hearing will be held in accordance with the requirements of 2 Pa.C.S. §§ 501—508 and 701—704 (relating to the Administrative Agency Law); section 8 of the Unfair Insurance Practices Act (40 P. S. § 1171.8) and the regulations set forth at 31 Pa. Code § 59.7(e) (relating to appeal procedures). Under 31 Pa. Code § 59.7(e)(5), procedural matters will be in conformance with 1 Pa. Code Part II (relating to General Rules of Administrative Practice and Procedure) unless specific exemption is given.

After the hearing, the Insurance Commissioner will issue a written order resolving the factual issues presented at the hearing and stating what remedial action, if any, is required. The Commissioner's Order will be sent to those persons participating in the hearing or their designated representatives. The order of the Commissioner is subject to judicial review by the Commonwealth Court.

Persons with a disability who wish to attend the above-referenced administrative hearing and require an auxiliary aid, service or other accommodation to participate in the hearing should contact Tracey Pontius, Agency Coordinator at (717) 787-4298.

M. DIANE KOKEN,  
*Insurance Commissioner*

[Pa.B. Doc. No. 99-1071. Filed for public inspection July 2, 1999, 9:00 a.m.]

### State Farm Fire and Casualty Company; Private Passenger Automobile Rate and Rule Revision

On June 11, 1999, the Insurance Department received from State Farm Fire and Casualty Company a filing for a rate level change for private passenger automobile insurance.

State Farm Fire and Casualty Company requests an overall 4.5% decrease amounting to —\$4,300,000 annually, to be effective September 1, 1999, for new and renewal business.

Unless formal administrative action is taken prior to August 10, 1999, the subject filing may be deemed approved by operation of law.

Copies of the filing will be available for public inspection, by appointment, during normal working hours at the Insurance Department's offices in Harrisburg, Philadelphia, Pittsburgh and Erie.

Interested parties are invited to submit written comments, suggestions or objections to Chuck Romberger, CPCU, Insurance Department, Bureau of Regulation of

Rates and Policies, Room 1311, Strawberry Square, Harrisburg, PA 17120 (e-mail at cromberg@ins.state.pa.us) within 30 days after publication of this notice in the *Pennsylvania Bulletin*.

M. DIANE KOKEN,  
*Insurance Commissioner*

[Pa.B. Doc. No. 99-1072. Filed for public inspection July 2, 1999, 9:00 a.m.]

## PENNSYLVANIA PUBLIC UTILITY COMMISSION

### Gas Service Without Hearing

**A-120650F0007. PFG Gas, Inc.** Application of PFG Gas, Inc. for a certificate of public convenience evidencing the Commission's approval of the transfer of a gathering system by PFG Gas, Inc. to Phoenix Energy Sales Company.

This application may be considered without a hearing. Protests or petitions to intervene can be filed with the Pennsylvania Public Utility Commission, P. O. Box 3265, Harrisburg, PA 17105-3265, with a copy served on the applicant on or before January 1, 1999, under 52 Pa. Code (relating to public utilities).

*Applicant:* PFG Gas, Inc.

*Through and By Counsel:* John H. Isom, PFG Gas Inc., 417 Walnut Street, Harrisburg, PA 17120.

JAMES J. MCNULTY,  
*Secretary*

[Pa.B. Doc. No. 99-1073. Filed for public inspection July 2, 1999, 9:00 a.m.]

### Railroad With Hearing

**A-00115212. Consolidated Rail Corporation.** Application of Consolidated Rail Corporation for the abolition of one grade crossing on Conrail's Chester Secondary located on 49th Street, in Philadelphia County, Philadelphia, PA (RDBR 10-0306).

An initial hearing on this matter will be held on Thursday, August 5, 1999, at 10 a.m. at 1302 Philadelphia State Office Building, 1400 West Spring Garden Street, Philadelphia, PA, when and where all persons in interest may appear and be heard, if they so desire.

JAMES J. MCNULTY,  
*Secretary*

[Pa.B. Doc. No. 99-1074. Filed for public inspection July 2, 1999, 9:00 a.m.]

have been filed with the Pennsylvania Public Utility Commission. Publication of this notice shall be considered as sufficient notice to all carriers holding authority from this Commission. Applications will be considered without hearing in the absence of protests to the application. Protests to the applications published herein are due on or before July 26, 1999, as set forth at 52 Pa. Code § 3.381 (relating to applications for transportation of property and persons). The protest shall also indicate whether it applies to the temporary authority application or the permanent application or both.

**Applications of the following for amendment to the certificate of public convenience approving the operation of motor vehicles as common carriers for transportation of persons as described under each application.**

**A-00108538, F. 1, Am-B. Main Line Taxi Co.** (514 South Woodbine Avenue, Narberth, Montgomery County, PA 19072), a corporation of the Commonwealth of Pennsylvania—persons upon call or demand in the townships of Marple, Upper Providence and Newtown, Delaware County, and that part of Lower Merion Township, Montgomery County, on and east of a line beginning at Waverly Road and the Schuylkill River, then southeastwardly along Waverly Road to its intersection with Morris Avenue, then southeasterly along Morris Avenue to its intersection with Old Gulph Road, then westward along Old Gulph Road to its merger with Robert Road, then southward along Robert Road to the Montgomery-Delaware County Line: *so as to permit* the transportation of persons upon call or demand in the township of Lower Merion and the boroughs of Conshohocken and West Conshohocken, Montgomery County; the township of Radnor, Delaware County and the township of Tredyffrin, Chester County. *Attorney:* Richard T. Mulcahey, Jr., Two Penn Center, Suite 1400, 1500 John F. Kennedy Boulevard, Philadelphia, PA 19102-1890.

**Applications of the following for approval of the beginning of the exercise of the right and privilege of operating motor vehicles as common carriers for the transportation of persons by transfer of rights as described under each application.**

**A-00115989. Centregistics Unlimited, Inc., t/d/b/a Tim Fischer's Limousine Services, Inc.** (1015 West College Avenue, State College, Centre County, PA 16801), a corporation of the Commonwealth of Pennsylvania—persons in limousine service, between points in the borough of State College, Centre County, and within an airline distance of 45 statute miles of the limits thereof, and from points in said area, to points in Pennsylvania, and return; which is to be a transfer of the limousine right authorized Handy Delivery, Inc., under the certificate issued at A-00107326, F. 3, subject to the same limitations and conditions.

JAMES J. MCNULTY,  
*Secretary*

[Pa.B. Doc. No. 99-1075. Filed for public inspection July 2, 1999, 9:00 a.m.]

### Service of Notice of Motor Carrier Applications

The following temporary authority and/or permanent authority applications for the right to render service as a common carrier or contract carrier in this Commonwealth

### Sewer Service Without Hearing

**A-230370F2000. The Preston Drainage Company.** Application of the Preston Drainage Company for ap-

proval of the transfer of private sewerline to Haverford Township and the abandonment of service by Preston Drainage Company.

This application may be considered without a hearing. Protests or petitions to intervene can be filed with the Pennsylvania Public Utility Commission, P. O. Box 3265, Harrisburg, PA 17105-3265, with a copy served on the applicant on or before January 1, 1999, under 52 Pa. Code (relating to public utilities).

*Applicant:* Preston Drainage Company.

*Through and By Counsel:* Fred C. Aldridge, Jr., Esq., Preston Drainage Company, 940 West Valley Road, Suite 1601, Wayne, PA 19087.

JAMES J. MCNULTY,  
*Secretary*

[Pa.B. Doc. No. 99-1076. Filed for public inspection July 2, 1999, 9:00 a.m.]

## PHILADELPHIA REGIONAL PORT AUTHORITY

### Request for Proposals

The Philadelphia Regional Port Authority (PRPA) will accept proposals until 2 p.m. on Thursday, July 15, 1999, for Project # 99-169-001 (Multimedia Computer Equipment).

The bid documents can be obtained from the Director of Procurement, 210 W. Washington Square, 13th Floor, Philadelphia, PA 19106, (215) 928-9100 and will be available July 7, 1999. PRPA is an equal opportunity employer. The contractor will be required to comply with all applicable equal employment opportunity laws and regulations.

JAMES T. MCDERMOTT, Jr.,  
*Executive Director*

[Pa.B. Doc. No. 99-1077. Filed for public inspection July 2, 1999, 9:00 a.m.]

## TURNPIKE COMMISSION

### Retention of an Engineering Firm

#### Preliminary and Final Design

#### Expansion of the Valley Forge Interchange Toll Plaza

#### Montgomery County

#### Reference No. 4-052

The Turnpike Commission will retain an engineering/architectural firm to prepare preliminary design and final design plans for expansion of the Valley Forge Interchange Toll Plaza (Milepost 326.3) to provide an expanded facility and maintain access through the toll plaza in Upper Merion Township, Montgomery County, PA.

The required engineering services for adding several toll islands and lanes to the east will include field surveys, coordination with utility companies and services, soils investigations and corresponding reports. In addition,

the necessary plans and contract documents will be required for modifying interchange signing and lighting plans, maintenance and protection of traffic plans, construction staging, contour grading and drainage, roadside development, architectural capabilities to perform plaza design and all other related work as may be necessary for a complete and final design of the intended project. The work may involve modifications to the canopy, toll booths and utility building.

The following factors will be considered by the Commission during the evaluation of the firms submitting Letters of Interest for this project:

a. Specialized experience and technical competence of prime consultant and subconsultants. The Team must clearly demonstrate an ability to analyze available data to make decisions and develop plans to complete the project in a timely and cost effective manner.

b. Past record of performance with respect to cost control, work quality ability to meet schedules and previous experience on similar projects. The consultant should identify similar projects that have been completed by that firm as the prime, the magnitude of the project, and the client.

c. The specific experience and number of individuals who constitute the firm.

d. Location of consultant's office where the work will be performed.

e. Workload of the prime consultant and subconsultants for all Pennsylvania Department of Transportation and Pennsylvania Turnpike Commission projects.

f. Other factors, if any, specific to the project.

Address these items and any necessary further details in a brief yet comprehensive manner in the letter of interest.

The Turnpike Commission is committed to the inclusion of disadvantaged, minority and woman firms in contracting opportunities. The minimum participation level for DBE/MBE/WBEs in this contract will be 10%. Responding firms shall clearly identify DBE/MBE/WBE firms, expected to participate in this contract, in their letter of interest. If the selected firm does not meet the minimum requirement for DBE/MBE/WBE participation, they will be required to demonstrate good faith efforts to achieve the required level. Proposed DBE/MBE/WBE firms must be certified by the Pennsylvania Department of Transportation at the time of the submission of the letter of interest. If further information is desired concerning DBE/MBE/WBE participation, direct inquiries to the Office of Equal Opportunity Development, Pennsylvania Turnpike Commission at the above address, or by calling (717) 939-9551 Ext. 4241.

Direct inquires to Jeffrey R. White at (717) 939-9551, Extension 3670; or by e-mail at [jwhite@paturndpike.com](mailto:jwhite@paturndpike.com).

#### General Requirements and Information

Firms interested in providing the above work and services are invited to submit a Letter of Interest with the required information. The Letters of Interest must include the following:

1. One page transmittal letter clearly identifying the project reference number, brief description of the project from the advertisement, the firm's Federal identification number, the firm's legal name, contact person or project manager, address of corporate office and project office. (If the firm has multiple offices, the location of the office performing the work must be identified)

2. Three page expression of interest in the advertised project. Each firm should demonstrate their ability to perform the specific requirements indicated for this project and provide explanation that the firm has successfully completed similar type projects of the same magnitude.

3. An organization chart for the Project, identifying key personnel and any subconsultants and their roles. Any deviation from the subconsultant's listed in the letter of interest will require written approval from the Commission.

4. Tabulation of workload for the prime consultant and all subconsultants for all Pennsylvania Department of Transportation and Pennsylvania Turnpike Commission projects.

5. A copy of the Annual Qualification Package submitted to the Pennsylvania Department of Transportation for the current year that is in the same District as the project or one that is best suited for the project.

The Annual Qualification Package should contain at a minimum, the following information for the prime consultant and all subconsultants which should be attached to the back of the letter of interest (subs to follow primes):

- Standard Form (SF) 254—Architect-Engineer and Related Services Questionnaire in its entirety, not more than 1 year old as of the date of the advertisement.
- Resumes of key personnel expected to be involved in the project. (limit to one 8 1/2 x 11 page, one side, per person). Only resumes of key personnel should be included.
- Copy of the firm's registration to do business in the Commonwealth as provided by the Department of State for firms with out-of-State headquarters or corporations not incorporated in Pennsylvania.
- A copy of the Department's DBE/WBE Certification, if applicable.

If a Joint Venture responds to a project advertisement, the Commission will not accept separate letters of interest from joint venture constituents. A firm will not be permitted to submit a letter of interest on more than one joint venture for the same project reference number. Also, a firm that responds to a project as a prime may not be included as a designated subconsultant to another firm that responds to the same project advertisement. This does not preclude a firm from being set forth as a designated subconsultant to more than one prime consultant responding to the project advertisement.

Firms interested in performing the above services are invited to submit a letter of interest and required information to Barry L. Troup, P.E., Assistant Chief Engineer for Design, at the PA Turnpike Commission Administration Building located on Eisenhower Boulevard at the Harrisburg-East Interchange (No. 19). (FedEx address: Route 283 and Eisenhower Boulevard, Highspire, PA 17034) (Mailing Address: P. O. Box 67676, Harrisburg, PA 17106-7676).

The letter of interest and required information must be received by 12 noon, Friday, July 23, 1999. Any letters of interest received after this date and time will be time-stamped and returned.

Based on an evaluation of acceptable letters of interest received in response to this solicitation, one firm will be selected for each project. The order of preference will be established for the purpose of negotiating an agreement

with the highest ranked firm established by the Technical Review Committee and approved by the Selection Committee. Technical Proposals or Requests for Proposals will not be requested prior to selection.

The Commission reserves the right to reject all letters of interest, to cancel solicitation requested under this notice, and/or to re-advertise solicitation for the work and services.

JAMES F. MALONE, III,  
*Chairperson*

[Pa.B. Doc. No. 99-1078. Filed for public inspection July 2, 1999, 9:00 a.m.]

## Retention of an Engineering Firm

### Systemwide Biennial Bridge Inspection

#### Reference No. 3-114

The Turnpike Commission will retain an engineering firm to perform the reinspection of approximately 850 structures owned by the Turnpike Commission. The structures include bridges that are 8 feet or more in length and culverts which are 20 feet or more in length. The work will be performed in order to meet the current national bridge inspection standards of the Federal Highway Administration and the Pennsylvania Department of Transportation's Bridge Management System (BMS).

The superstructure and substructure of each bridge shall be inspected, rated and appraised based on criteria and guidelines defined in the following documents:

1. National Bridge Inspection Standards (NBIS).
2. AASHTO Manual for Maintenance Inspection of Bridges 1983, including the 1990 revision.
3. Bridge Inspector's Training Manual 90.
4. Culvert Inspection Manual, Report No. FHWA-IP-86-2.
5. Inspection of Fracture Critical Bridge Members, Report No. FHWA-IP-86-26.
6. Bridge Management System (BMS) Coding Manual, Department Publications 100A October 1993, and its updates.
7. Manual for Inspecting Bridge for Fatigue Damage Conditions, Research Project No. 85-02.
8. Bridge Safety Inspection Manual, Policies and Procedures, Publication 238, January 1989, and its updates.
9. BMS Coding Forms D-491 and their updates or a printout of the individual structure records from BMS.
10. BMS Inspection Forms D-450 Series and their updates.

The consultant must follow the existing 2-year interval schedule. Work performed must be completed by January 31, 2002.

The following factors will be considered by the Commission during the evaluation of the firms submitting letters of interest for this project:

- a. Specialized experience and technical competence of prime consultant and subconsultants. The Team must clearly demonstrate an ability to analyze available data to make decisions and develop plans to complete the project in a timely and cost effective manner.

b. Past record of performance with respect to cost control, work quality ability to meet schedules and previous experience on similar projects. The consultant should identify similar projects that have been completed by that firm as the prime, the magnitude of the project, and the client.

c. The specific experience and number of individuals who constitute the firm.

d. Location of consultant's office where the work will be performed.

e. Workload of the prime consultant and subconsultants for all Department of Transportation and Turnpike Commission projects.

f. Number of certified inspectors and inspection teams available for this assignment and their qualifications.

g. Capabilities of the proposed teams to address the

bridge inspection, engineering evaluations and recommendations.

h. Internal procedures for cost containment and quality assurance.

j. Other factors, if any, specific to the project.

Address these items and any necessary further details in a brief yet comprehensive manner in the letter of interest.

Direct inquires to James L. Stump, P.E., at (717) 939-9551, Extension 5540; or by e-mail at [jstump@paturndpike.com](mailto:jstump@paturndpike.com).

JAMES F. MALONE, III,  
*Chairperson*

[Pa.B. Doc. No. 99-1079. Filed for public inspection July 2, 1999, 9:00 a.m.]

# STATE CONTRACTS INFORMATION

## DEPARTMENT OF GENERAL SERVICES

Notices of invitations for bids and requests for proposals on State contracts for services and commodities for which the bid amount is reasonably expected to be over \$10,000, are published in the State Contracts Information Section of the *Pennsylvania Bulletin* prior to bid opening date. Information in this publication is intended only as notification to its subscribers of available bidding and contracting opportunities, and is furnished through the Department of General Services, Vendor Information and Support Division. No action can be taken by any subscriber or any other person, and the Commonwealth of Pennsylvania is not liable to any subscriber or any other person, for any damages or any other costs incurred in connection with the utilization of, or any other reliance upon, any information in the State Contracts Information Section of the *Pennsylvania Bulletin*. Interested persons are encouraged to call the contact telephone number listed for the particular solicitation for current, more detailed information.

**EFFECTIVE JULY 1, 1985, A VENDOR'S FEDERAL IDENTIFICATION NUMBER (NUMBER ASSIGNED WHEN FILING INCOME TAX DOCUMENTS) OR SOCIAL SECURITY NUMBER IF VENDOR IS AN INDIVIDUAL, MUST BE ON ALL CONTRACTS, DOCUMENTS AND INVOICES SUBMITTED TO THE COMMONWEALTH.**

Act 266 of 1982 provides for the payment of interest penalties on certain invoices of "qualified small business concerns". A qualified small business concern is an independently owned, operated for profit, business employing 100 or fewer employes and is not a subsidiary or affiliate of a corporation otherwise not qualified.

Such penalties apply to invoices for goods or services when payments are not made by the required payment date or within a 15 day grace period thereafter. The small business concern must include on every invoice submitted to the Commonwealth: "(name of vendor) is a qualified small business concern as defined at 4 Pa. Code § 2.32".

For information on the required payment date and annual interest rate, please call the Pennsylvania Department of Commerce, Small Business Action Center, 483 Forum Building, 783-5700.

### Reader's Guide

## Legal Services & Consultation—26

- ① Service Code Identification Number
- ② Commodity/Supply or Contract Identification No.
- ③ Contract Information
- ④ Department
- ⑤ Location
- ⑥ Duration
- ⑦ (For Commodities: Contact: Vendor Services Section 717-787-2199 or 717-787-4705)

**B-54137.** Consultant to provide three 2-day training sessions, covering the principles, concepts, and techniques of performance appraisal and standard setting with emphasis on performance and accountability, with a knowledge of State Government constraints.  
 Department: General Services  
 Location: Harrisburg, Pa.  
 Duration: 12/1/93-12/30/93  
 Contact: Procurement Division 787-0000

### REQUIRED DATA DESCRIPTIONS

- ① Service Code Identification Number: There are currently 39 state service and contractual codes. See description of legend.
- ② Commodity/Supply or Contract Identification No.: When given, number should be referenced when inquiring of contract of Purchase Requisition. If more than one number is given, each number represents an additional contract.
- ③ Contract Information: Additional information for bid preparation may be obtained through the departmental contracting official.
- ④ Department: State Department or Agency initiating request for advertisement.
- ⑤ Location: Area where contract performance will be executed.
- ⑥ Duration: Time estimate for performance and/or execution of contract.
- ⑦ Contact: (For services) State Department or Agency where vendor inquiries are to be made.  
 (For commodities) Vendor Services Section (717) 787-2199 or (717) 787-4705



## GET A STEP AHEAD IN COMPETING FOR A STATE CONTRACT!

The Treasury Department's Bureau of Contracts and Public Records can help you do business with state government agencies. Our efforts focus on guiding the business community through the maze of state government offices. The bureau is, by law, the central repository for all state contracts over \$5,000. Bureau personnel can supply descriptions of contracts, names of previous bidders, pricing breakdowns and other information to help you submit a successful bid on a contract. We will direct you to the appropriate person and agency looking for your product or service to get you "A Step Ahead." Services are free except the cost of photocopying contracts or dubbing a computer diskette with a list of current contracts on the database. A free brochure, "Frequently Asked Questions About State Contracts," explains how to take advantage of the bureau's services.

Contact: **Bureau of Contracts and Public Records**  
 Pennsylvania State Treasury  
 Room G13 Finance Building  
 Harrisburg, PA 17120  
 717-787-2990  
 1-800-252-4700

BARBARA HAFER,  
*State Treasurer*

**Online Subscriptions At <http://www.statecontracts.com> 1-800-334-1429 x340**

### Commodities

**1037229** Marine equipment and supplies—62,535 CCF bulk liquid oxygen.

**Department:** Fish and Boat Commission  
**Location:** Bellefonte, Centre County, PA  
**Duration:** FY 98—99  
**Contact:** Vendor Services: fax request to (717) 787-0725 or call (717) 787-2199

**104111** Lighting fixtures, lamps and clocks—36 each fixtures, 400 watt Hi-bay, filterglow luminaire, metal halide multivolt ballast General Electric No. GEWLFGS 40 MOA614E7 or approved equal; 45 each fixture, 12" x 12" wall type, metal halide, vandal resistant, luminaire horizon eyelid 70 watt, NPF ballast, 120 volt. Lumark No. LUKMHG70N120 or approved equal.

**Department:** Corrections  
**Location:** Bellefonte, Centre County, PA  
**Duration:** FY 98—99  
**Contact:** Vendor Services: fax request to (717) 787-0725 or call (717) 787-2199

**850495** Prefab structures and scaffolding—1 each Timberdeck, prefabricated structure.

**Department:** Transportation  
**Location:** Shippenville, Clarion County, PA  
**Duration:** FY 98—99  
**Contact:** Vendor Services: fax request to (717) 787-0725 or call (717) 787-2199

**1024159** Recreation equipment—1 each Stair Climber, Ref: Climbmax 2000 Tectrix Stepper by Cybex or approved equal; 3 each cycle ergometer to have wide range of speeds: 30, 60, 90, 120, 150 rpm Ref: Cybex Fitron Isokinetic Cycle Ergometer or approved equal; 1 each strength system, 205 LBW, size 28" W x 43" L x 67" H, Ref: Cybex VR2, Product No. 4715 or approved equal; 1 each strength system, chest press with single axis. Wt. stack: 305 lbs.; size: 56" w x 46" L x 76" H. Ref: Cybex VR2, Product No. 4506 or approved equal. 1 each strength system, variable resistance, upper body—lateral raise. Wt. stack: 255 lbs.; size: 40" w x 52" L x 67" H. Ref: Cybex VR-2 Product No. 4530 or approved equal; 1 each strength system, variable resistance, lower body, rotary hip. Wt. stack: 200 lbs.; size: 46" W x 45" L x 60" H. Ref: Cybex VR, Product Code 4865 or approved equal. 1 each strength system, variable resistance, trunk and torso, back extension w/total Rld. Wt. stack: 305 lbs.; Size: 41" W x 50" L x 61" H Ref: Cybex VR-2, Product Code No. 4713 or approved equal. 1 each shoulder internal/external rotation. Wt. stack: 110 lb. Ref: Cybex VR, Product No. 4065 or approved equal. 1 each wrist and forearm. Wt. stack: 107.5 lb., size: 51" W x 31" L x 62" H. Ref: Cybex VR, Product Code No. 4050 or approved equal. 1 each strength system, variable resistance, lower body, leg extension w/total RLD. Wt. stack: 305 lbs. Size: 39" W x 50" L x 61" H. Ref: Cybex VR2, Product No. 4613 or approved equal. 1 each strength system, variable resistance, lower body—seated leg curl w/total RLD. Wt. stack: 205 lbs. Size: 39" W x 70" L x 61" H Ref: Cybex VR-2, Product No. 4628 or approved equal. 1 each strength system, variable resistance, upper body—row/rear delt. Wt. stack: 305 lbs.; Size: 27" W x 62" L x 82" H. Ref: Cybex VR2, Product Code No. 4520 or approved equal.

**Department:** California University  
**Location:** California, Washington County, PA  
**Duration:** FY 98—99  
**Contact:** Vendor Services: fax request to (717) 787-0725 or call (717) 787-2199

**1038189** Paper and printing—60 M/Sets REV-1399 PA-2000 Intra-State decals—60,000 sets of two identical decals yielding a total of 120,000 decals. 150 M/sets REV-1399 IFTA—2000 Inter-State International Fuel Tax Agreement decals—150,000 sets of two identical decals, yielding a total of 300,000 decals.

**Department:** Revenue  
**Location:** Harrisburg, Dauphin County, PA  
**Duration:** FY 98—99  
**Contact:** Vendor Services: fax request to (717) 787-0725 or call (717) 787-2199

**1061389** Manual—1 Lot—7 million copies of special fund license plate application. Any questions concerning the artwork should be directed to Lisa Cook, DCNR, Graphics, (717) 772-4751. Stock: Starbrite, Opaque, Recycled, white smooth finish 60 lb. text or approved equal. Size—Flat: 8 1/2" x 11"; folded 8 1/2" x 3 1/2". Printing: two sided—black ink text. One-side—4 color (CMYK). One-sided—1 color black.

**Department:** Conservation and Natural Resources  
**Location:** Harrisburg, Dauphin County, PA  
**Duration:** FY 98—99  
**Contact:** Vendor Services: fax request to (717) 787-0725 or call (717) 787-2199

---

# SERVICES

---

## Advertising—01

**0200-30** Contractor shall furnish imprinted promotional items such as pens, pencils, sticky note pads, magnets, key ring lights, tag light key rings, water bottles, and binoculars. Artwork will be supplied by PA Department of Transportation, but the contractor may need to prepare the artwork for imprinting. Contract shall be awarded by competitive bid. Requests for bid packages can be faxed to Janis Miele at (814) 765-0424 or phone (814) 765-0404. To request a bid package you must supply your full company name, address, phone number, fax number and contact person.

**Department:** Transportation  
**Location:** 1924—30 Daisy Street, (Route 322 and Leonard Street), P. O. Box 342, Clearfield, PA 16830  
**Duration:** Within 60 days after receipt of approved Field Purchase Order  
**Contact:** Janis Miele, (814) 765-0404

---

## Computer Related Services—08

**SC159936** Millersville University is seeking qualified bidders who can provide the University with a Computer Maintenance Management System. The system must be able to encompass all aspects of maintenance functions. Interested vendors should fax their requests to be placed on a bidders list to Anna Stauffer, fax (717) 871-2000 no later than 2 p.m., Friday, July 9, 1999.

**Department:** State System of Higher Education  
**Location:** Millersville University, Millersville, PA 17551  
**Duration:** October 1999—December, 1999  
**Contact:** Anna Stauffer, (717) 872-3041

---

**KURFP-0004:** Kutztown University is seeking to solicit proposals from distributors or leading personal computer manufacturers who would be responsible for leasing personal computers to the University. Kutztown seeks to establish a master lease agreement to allow University department to enter into lease agreement with the lessor. The master lease will serve as a blanket agreement to cover the University departmental leases over a period of time. Those firms interested in receiving an RFP package must request it in writing and direct it to: Barbara Reitz, Director of Purchasing, Kutztown University, Kutztown, PA 19530, phone (610) 683-4132; fax (610) 683-4674 or e-mail: reitz@kutztown.edu. RFP packages will be available July 6, 1999. Questions requiring clarifications prior to proposal submission must be submitted by July 20, 1999. Proposals are due by 2 p.m. on August 3, 1999.

**Department:** State System of Higher Education  
**Location:** Kutztown University, Kutztown, PA 29530  
**Duration:** 1 year after notice to proceed with option to renew for 4 additional terms  
**Contact:** Barbara Reitz, (610) 683-4132

---

## Construction and Construction Maintenance—09

**FDC-313-583** Installation of Stop Logs, a Gantry Lifting Crane and electric trolley hoist in the tower existing control wer of the dam at Shawnee State Park.

**Department:** Conservation and Natural Resources  
**Location:** Shawnee State Park  
**Duration:** 90 days  
**Contact:** R. P. Stakem, (717) 787-5055

---

**015DGSA999-110** Project title: New Roof for Mather Mill. Brief description: Remove the existing wood shingle roof, replace deteriorated sheathing and flashing and install a new red cedar shingle roof. Estimated range: under \$100,000. General Construction. Plans deposit: \$25 per set. Payable to: The Commonwealth of Pennsylvania. Refundable upon return of plans and specifications in reusable condition as construction documents within 15 days after the bid opening date. The bidder is responsible for the cost of delivery of the plans and specifications. Contact the office listed to arrange for delivery of documents. A separate check must be submitted to cover the cost of delivery. Mail a separate check for \$5 per set or provide your express mail account number to the office listed. Mail requests to: The Department of General Services, Room 107, Headquarters Building, 18th and Herr Streets, Harrisburg, PA 17125, (717) 787-3923. Bid date: Wednesday, July 21, 1999 at 1 p.m.

**Department:** General Services  
**Location:** Hope Lodge  
**Duration:** 120 calendar days from date of initial job conference  
**Contact:** Contract and Bidding Unit, (717) 787-6556

---

**015DGSA225-9** Project title: Restore Bituminous Paving Areas. Brief description: Restore bituminous paving as needed surrounding headquarters complex. Estimated range: under \$100,000. Miscellaneous Construction. Plans deposit: \$25 per set. Payable to: The Commonwealth of Pennsylvania. Refundable upon return of plans and specifications in reusable condition as construction documents within 15 days after the bid opening date. The bidder is responsible for the cost of delivery of the plans and specifications. Contact the office listed to arrange for delivery of documents. A separate check must be submitted to cover the cost of delivery. Mail a separate check for \$5 per set or provide your express mail account number to the office listed. Mail requests to: The Department of General Services, Room 107, Headquarters Building, 18th and Herr Streets, Harrisburg, PA 17125, (717) 787-3923. Bid date: Wednesday, July 21, 1999 at 11 a.m.

**Department:** General Services  
**Location:** PA State Police Troop  
**Duration:** 90 calendar days from date of initial job conference  
**Contact:** Contract Bidding Unit, (717) 787-6556

---

**410-BL-592.1** Nelson Field House Roof Restoration—Provide labor, equipment and material necessary to replace a limited amount of insulation, refasten and reseam existing membrane, and install a new fluid-applied roof coating system to existing building. There will be one prime contractor for the project a general contractor. To obtain a set of bid specifications a non-refundable deposit of \$30 should be sent to Comprehensive Design Architects/Engineers, 3054 Enterprise Drive, State College, PA 16801-2755, telephone (814) 238-7706. All necessary information regarding the project including specifications, prebid and bid opening dates will be included in the package.

**Department:** State System of Higher Education  
**Location:** Bloomsburg University, Bloomsburg, PA  
**Duration:** 60 days  
**Contact:** Joseph C. Quinn, (570) 389-4311

---

**FDC-428-473** Excavation, backfill, compaction and grading; paving (AASHTO No. 1 stone—600 tons, No. 2A aggregate—800 tons, BCBC—3,300 tons, ID-2—2,000 tons, prime coat—200 s. y.; riprap (R4)—20 s. y.; 6 inlets, 18" CPP—150 l. f., 24" CPP—990 l. f., 4" U-drain—2,000 l. f.; seeding and mulching. All work is at Locust Lake State Park.

**Department:** Conservation and Natural Resources  
**Location:** Locust Lake State Park, Ryan Township, PA  
**Duration:** Complete all work by November 19, 1999  
**Contact:** Construction Management Section, Bureau of Facilities, (717) 787-5055

**2-1-0003** This contract will provide manpower, equipment and incidental guiderail material for installation of approximately 30,000 linear feet of guiderail at various locations throughout Centre County. All guiderail material will be supplied by the Department of Transportation except for the bolts, nuts, washers, rotating brackets, bridge connection plates, anchor bolts, concrete for the end treatment and end anchorages. It will be the Contractor's responsibility to pick up the material and deliver it to the work sites. A mandatory prebid meeting (only 1 day) will be held to include review of the guiderail locations, and a site will be determined where the guiderail will be stored. The Department shall be responsible for removal of all existing guiderails and for any grading of shoulder stabilization prior to the placement of the guiderail by the contractor. All requests for bid packages must be received by fax (814) 355-5930 or telephone (814) 355-4731.

**Department:** Transportation  
**Location:** Various locations within Centre County, PA  
**Duration:** One year contract  
**Contact:** Tina A. Smith, (814) 355-4731

**015DGS947-5 Revised Rebid** Project Title: Restoration and Preservation of Feast Hall. Brief description: Work includes general restoration of existing building, consisting of demolition, masonry, repointing, concrete work, carpentry, reroofing, metal flashing, painting, plumbing fixtures and piping and miscellaneous electrical work. Estimated range: \$500,000 to \$1,000,000. General, plumbing and electrical construction. Plans deposit: \$80 per set. Payable to: Roger A. Weaver, Architect. Refundable upon return of plans and specifications in reusable condition as construction documents within 15 days after the bid opening date. The bidder is responsible for the cost of delivery of the plans and specifications. Contact the office listed to arrange for delivery of documents. A separate check must be submitted to cover the cost of delivery. Mail requests to: Roger A. Weaver, Architect, 233 Mercer Street, Harmony, PA 16037, telephone (724) 452-5740. Bid date: Wednesday, August 4, 1999 at 11 a.m. A prebid conference has been scheduled for Wednesday, July 14, 1999 at 10 a.m. at Old Economy Village, Ambridge, PA. Meet at front desk. Contact: Roger A. Weaver, (724) 452-5740. All contractors who have secured contract documents are invited and urged to attend this prebid conference.

**Department:** General Services  
**Location:** Old Economy Village, Ambridge, PA  
**Duration:** 210 calendar days from date of initial job conference  
**Contact:** Contract and Bidding Unit, (717) 787-6556

**FDC-413-639** Construction of road and parking lot at Tuscarora State Park. Excavation, backfilling, compaction and grading; paving (2A aggregate—1,400 tons, BCBC—1,250 tons, ID-2 wearing—600 tons and prime coat—400 s. y.); pavement markings: 10 s. y. of riprap; 3—inlets; 18-inch C.P. pipe—350 l. f. and 3 end sections; signing; seeding and mulching; concrete curb and sidewalks—45 c. y.

**Department:** Conservation and Natural Resources  
**Location:** Tuscarora State Park, Rush Township, PA  
**Duration:** May 24, 2000  
**Contact:** Robert P. Stakem, (717) 787-5055

## Engineering Services—14

**08430AG2371** Specific project agreement to perform NBIS bridge safety inspections for designated bridges on the State system throughout Engineering District 9-0: that is Bedford, Blair, Cambria, Huntingdon and Somerset Counties. For a bid package please contact the Consultant Agreement Division at (717) 783-9309.

**Department:** Transportation  
**Location:** Engineering District 9-0  
**Duration:** Twenty-four months  
**Contact:** Consultant Agreement Division, (717) 783-9309

## Food—19

**SCIA9914** Contractor to supply Post Mix soda beverage syrup furnished in 5 gallon Bag-in-a-Box containers and CO<sub>2</sub> containers necessary for dispensing. Regular, diet and/or caffeine free flavors to be chosen by the agency. To also include product delivery, necessary dispensing equipment, and equipment maintenance for 3 years.

**Department:** Corrections  
**Location:** State Correctional Institution at Albion, 10745 Route 18, Albion, PA 16475  
**Duration:** September 1, 1999 to August 31, 2002  
**Contact:** Michelle R. Wagner, (814) 756-9751

## Fuel Related Services—20

**1020** Installation of two vertical, free-standing, 5,000 gallons polyethylene tanks. To be installed at our Butler County stockpiles locations as specified in the specifications of the liquid calcium tanks. To obtain a bid package contact Andrew Skunda at (724) 284-8226.

**Department:** Transportation  
**Location:** 351 New Castle Road, Butler, PA 16001  
**Duration:** December 31, 1999  
**Contact:** Andrew A. Skunda, (724) 284-8226

## HVAC—22

**90972001** Duct cleaning services in various buildings at Mayview State Hospital. Cleaning includes fans and fan accessories for both new and existing equipment within work area. Vendor is to provide all labor, equipment accessories and materials and shall perform all operations necessary for the cleaning of all air moving equipment for the HVAC systems. Vendor must guarantee removal of a minimum of 95% of dust, dirt and debris from the system. Call purchasing at (412) 257-6215 for a copy of the bid specifications.

**Department:** Public Welfare  
**Location:** Mayview State Hospital, 1601 Mayview Road, Bridgeville, PA 15017-1599  
**Duration:** October 01, 1999—June 30, 2000  
**Contact:** F. Molisee, (412) 257-6215

**SP 90777014** Automatic temperature control service. Maintain, adjust, calibrate and repair. To obtain a bid package contact Stanley Rygelski at (570) 587-7291.

**Department:** Public Welfare  
**Location:** Clarks Summit State Hospital, 1451 Hillside Drive, Clarks Summit, PA 18411-9505  
**Duration:** July 1, 1999 through June 30, 2000  
**Contact:** Stanley Rygelski, (570) 587-7291

## Janitorial Services—23

**6500-082** Vendor shall supply base chemicals for 3M-Compblend machines located at the State Correctional Institution at Retreat, Hunlock Creek, PA. Bids shall be issued per institutional requirements. Specifications on file at institutional purchasing office.

**Department:** Corrections  
**Location:** State Correctional Institution at Retreat, 660 State Route 11, Hunlock Creek, PA 18621  
**Duration:** July 1, 1999 through June 30, 2000  
**Contact:** Barbara Swiatek, Purchasing Agent, (570) 735-8754

**Lodging/Meeting Facilities—27**

**CLD-P1508** Provide conference facility, meeting rooms, lodging and meals per bid specifications, for the Office of Attorney General's Statewide CLD agent conference to be held January 25—27, 2000. To obtain a bid package contact Jean Kreiser at (717) 787-4745.

**Department:** Attorney General  
**Location:** Within twenty miles of Harrisburg Metropolitan area  
**Duration:** January 25—27, 2000  
**Contact:** Jean Kreiser, (717) 787-4745

**SBC 119901** Provide meeting space and lodging for Statewide Keep PA Beautiful Conference on October 6, 7 and 8, 1999 (firm dates). Conference meeting space: main room 125 people (classroom style); breakout room for 40 people. Lodging: single rooms for 120 people; meals: October 6, 1999, p.m. break: October 7, 1999, Continental breakfast, buffet lunch (must be held in a separate room from main conference meeting room). October 8, 1999, buffet breakfast, a.m. break. Quantities are estimated. To receive a bid package fax your name, address, telephone and fax number to: Mike Dutko at (814) 724-8647. Reference SBC 119901 on your fax.

**Department:** Transportation  
**Location:** Conference site—located within 15 mile radius of Pittsburgh Airport  
**Duration:** October 6—8, 1999  
**Contact:** Michael J. Dutko, (814) 332-6880

**Medical Services—29**

**SP 90777015** Radiology Services—Interpretation of Radiographs. To obtain a bid package contact Stanley Rygelski at (570) 587-7291.

**Department:** Public Welfare  
**Location:** Clarks Summit State Hospital, 1451 Hillside Drive, Clarks Summit, PA 18411-9505  
**Duration:** July 1, 1999 through June 30, 2000  
**Contact:** Stanley Rygelski, (570) 587-7291

**90873022** Neurological Consultative/Educative Services for evaluation and treatment of Harrisburg State Hospital patients with neurological deficits; and further, to provide formal education sessions to improve the diagnostic and treatment acumen of the medical staff. Contractor must have board eligibility or Board certification in Neurology. Services to be provided in a three and one half hour session one day per month.

**Department:** Public Welfare  
**Location:** Harrisburg State Hospital, Cameron and Maclay Streets, Harrisburg, PA 17105-1300  
**Duration:** August 1, 1999 through June 30, 2002—a period of 35 months  
**Contact:** Jack W. Heinze, (717) 772-7435

**SP359400002** Fixed site facility only, not mobile, to provide physicals to Department employees in the Williamsport area. Facility shall be located within 50 miles of downtown Williamsport.

**Department:** Environmental Protection  
**Location:** 208 West Third Street, Suite 101, Williamsport, PA 17701-6448  
**Duration:** August 01, 1999 to June 30, 2000 with options to renew  
**Contact:** Jane Allen, (570) 327-3694

**Personnel, Temporary—31**

**TNS-99** Vendor to supply on-call Registered Nurses to fill in for permanent staff who are on various types of leave.

**Department:** Military Affairs  
**Location:** Southeastern Veterans Center, 1 Veterans Drive, Spring City, PA 19475  
**Duration:** November 1, 1999 through June 30, 2001  
**Contact:** Theresa Barthel, Purchasing Agent, (610) 948-2493

**Property Maintenance—33**

**Bid No. 7952** Furnish all labor, materials and equipment to cut, trim and maintain grass area at the Tunkhannock Station. Four cuttings per month. Trim shrubs twice a year. Fertilization once a year. Detailed work schedule and bid must be obtained from Facility Management Division, (717) 783-5484.

**Department:** State Police  
**Location:** Tunkhannock Station, 915 SR6W, Tunkhannock, PA 18657-6148  
**Duration:** September 1, 1999—June 30, 2002  
**Contact:** Donna Enders, (717) 783-5484

**3091810004** Lawn care and snow removal. Approximately 20 cuttings of grass, including removal of tree/brush, limbs, branches and other debris as well as weed whacking and trimming. Response time within 24 hours for service. Approximately 10 snow removals of 3" or more on an as needed basis. Response time within 3 hours for service. The above figures are estimates based on a 1 year period.

**Department:** Historical and Museum Commission  
**Location:** Graeme Park, 859 County Line Road, Horsham, PA 19044  
**Duration:** August 1, 1999 through June 30, 2001 (with possible 1—2 year extensions)  
**Contact:** Loren Zuck or Patty Mousley, (215) 646-1595

**183089** Install new carpet in Chapel Building No. 32, Room No. 102. Complete specifications may be obtained by contacting the Hospital.

**Department:** Public Welfare  
**Location:** Warren State Hospital, 33 Main Drive, North Warren, PA 16365-5099  
**Duration:** August 01, 1999—November 01, 1999 (Anticipated)  
**Contact:** B. D. Muntz, (814) 726-4496

**063002** Removal of snow and ice from the entire length of Interstate Route 476 and the PennDOT District 6-0 parking lot in Delaware County and from the Blue Route Park and Ride lot in Montgomery County. Contract will require one supervisor-coordinator, and approximately 5 trucks at 33,000 lbs. GVW, 10 trucks at 47,000 lbs. GVW, two graders at 24,000 GVW, one 2 c. y. front end loader, one 1 1/2 c. y. front end loader, and one pick-up truck. Contractor will also supply plows and spreaders.

**Department:** Transportation  
**Location:** I-476 and District 6-0 Parking Lot in Delaware County and Park and Ride Lot in Montgomery County, PA  
**Duration:** Approximately from November 1, 1999 to April 30, 2000  
**Contact:** Charles Stone, (610) 964-6520

**061003** Removal of snow and ice from entire length of Interstate Route I-95 and from the Bensalem Park and Ride Lot in Bucks County. Contract will require two supervisor coordinators, 10 trucks at 47,000 lbs. GVW, four graders at 24,000 lbs. GVW, one 3 1/2 c. y. front end loader, one 1.5 c. y. front end loader, one truck at 33,000 lbs. GVW and people and equipment for snow removal on the sidewalks and Park and Ride Lot. Contractor will also supply plows and spreaders for the trucks.

**Department:** Transportation  
**Location:** Interstate Route 95 and the Bensalem Park and Ride Lot in Bucks County, PA  
**Duration:** Approximately from November 1, 1999 to April 30, 2000  
**Contact:** Charles Stone, (610) 964-6520

**CL500** Clarion University is soliciting bids for renovations to the interior of Davis Hall, a classroom/office building on the Clarion Campus. Alterations will be made in interior design, HVAC, plumbing (limited) and electrical systems. Contracts will be awarded for general, HVAC, plumbing and electrical. Bid packages available from contact person for \$20 nonrefundable deposit payable by check to the University mailed to 218 Carrier Hall. Prebid conference: 10 a.m., July 13 in the McEntire Maintenance Building. Bids due: 1:30 p.m., July 23, 1999.

**Department:** State System of Higher Education  
**Location:** Clarion University, Clarion, PA  
**Duration:** 120 days from Notice to Proceed  
**Contact:** Judy McAninch, (814) 226-2240

**Bid No. 7951** Furnish all labor, materials and equipment to cut, trim and maintain grass area at the Hamburg Station. Three cuttings per month, or as required by the Station Commander. Fertilization twice a year. Detailed work schedule and bid must be obtained from Facility Management Division, (717) 783-5484.

**Department:** State Police  
**Location:** Hamburg Station, 90 Industrial Drive, Hamburg, PA 19526  
**Duration:** September 1, 1999 to June 30, 2002  
**Contact:** Donna Enders, (717) 783-5484

**LH-MNT-2405** Furnish and install: Dryvit System (exterior insulating, finish system) and new flashing on Building No. 13 at State Correctional Institution Laurel Highlands. Site visit required. Complete specifications on file.

**Department:** Corrections  
**Location:** State Correctional Institution—Laurel Highlands, 5706 Glades Pike, Somerset, PA 15501-0631  
**Duration:** July 01, 1999 through September 30, 1999  
**Contact:** Betsy Nightingale, (814) 445-6501, ext. 347

**062005** Removal of snow and ice from the entire length of Route 202 in Chester County. Contract will require approximately 5 trucks at 33,000 lbs. GVW, 4 trucks at 53,000 lbs. GVW, one grader at 24,000 lbs. GVW and one 2 1/2 c. y. front end loader. Contractor will also supply plows and spreaders for the trucks.

**Department:** Transportation  
**Location:** Route 202 in Chester County, PA  
**Duration:** November 1, 1999 to April 30, 2001  
**Contact:** Charles Stone, (610) 964-6520

**062004** Removal of snow and ice from the entire lengths of Routes 1 and 41 in Chester County. Contract will require approximately 2 trucks at 33,000 lbs. GVW, 6 trucks at 53,000 lbs. GVW, two graders at 24,000 lbs. GVW and one 2 1/2 c. y. front end loader. Contractor will also supply plows and spreaders for the trucks.

**Department:** Transportation  
**Location:** Routes 1 and 41 in Chester County, PA  
**Duration:** November 1, 1999 to April 30, 2000  
**Contact:** Charles Stone, (610) 964-6520

**063005** Removal of snow and ice from the entire length of Interstate Route 95 in Delaware County. Contract will require a supervisor-coordinator and approximately 10 trucks at 47,000 lbs. GVW, two graders at 24,000 lbs. GVW and one 1 1/2 c. y. front end loader. Contractor will also supply plows and spreaders for the trucks.

**Department:** Transportation  
**Location:** Interstate Route 95 in Delaware County, PA  
**Duration:** Approximately from November 1, 1999 to April 30, 2000  
**Contact:** Charles Stone, (610) 964-6520

**063004** Removal of snow and ice from the entire length of Route 3 in Delaware County. Contract will require one supervisor-coordinator and approximately 12 trucks at 47,000 lbs. GVW and one 3 1/2 c. y. front end loader. Contractor will also supply plows and spreaders for the trucks.

**Department:** Transportation  
**Location:** Route 3 in Delaware County, PA  
**Duration:** Approximately from November 1, 1999 to April 30, 2000  
**Contact:** Charles Stone, (610) 964-6520

**063003** Removal of snow and ice from the entire length of Route 202 in Delaware County. Contract will require one supervisor-coordinator and approximately 6 trucks at 47,000 lbs. GVW. Contractor will also supply plows and spreaders for the trucks.

**Department:** Transportation  
**Location:** Route 202 in Delaware County, PA  
**Duration:** Approximately from November 1, 1999 to April 30, 2000  
**Contact:** Charles Stone, (610) 964-6520

**065002** Removal of snow and ice from I-76, I-95, I-676, Route 1 and Route 63 in Philadelphia County. Contract will require two supervisor coordinators, 26 trucks at 47,000 lbs. GVW, two 1 1/2 c. y. front end loaders and two graders at 24,000 lbs. GVW. If contractor does not have plows and spreaders, PennDOT Philadelphia County Office can supply them.

**Department:** Transportation  
**Location:** I-76, I-95, I-676, Route 1 and Route 63 in Philadelphia County, PA  
**Duration:** Approximately from November 1, 1999 to April 30, 2000  
**Contact:** Charles Stone, (610) 964-6520

## Security Services—37

**ADV No. 33** Indiana University of Pennsylvania (IUP) is seeking bids to Furnish Only and Program, Park and Pay Stations for Campus Police on the main campus, Indiana, PA 15705. Acceptable manufacturer: Schlumberger, or approved equal. Requests for a bid package should be made in writing, referencing Advertisement No. 33 and directed to Patty Bash, Purchasing Agent, IUP, 650 South 13th Street, Indiana, PA 15705, fax (724) 357-2670, phone (724) 357-3077, or e-mail: PABash@grove.iup.edu. Requests for bid packages will be accepted until July 2, 1999. The University encourages responses from small and disadvantaged, minority and women-owned firms.

**Department:** State System of Higher Education  
**Location:** Indiana University of Pennsylvania, Indiana, PA 15705  
**Duration:** Indeterminate 1998—99  
**Contact:** Patty Bash, (724) 357-3077

## Miscellaneous—39

**X5999** Provide one mobile air monitoring instrument shelter.

**Department:** Environmental Protection  
**Location:** Harrisburg, PA  
**Duration:** Should be delivered by August 5, 1999  
**Contact:** Dawn Levarto, (717) 787-9645

**081** The Governor's Office of Administration is soliciting proposals from Enterprise Resource Planning (ERP) vendors which are interested in having their product suite selected for accounting, budget, payroll, and purchasing applications for agencies under the Governor's jurisdiction.

**Department:** Governor's Office  
**Location:** Commonwealth Technology Center, 1 Technology Park, Harrisburg, PA 17110-2913  
**Duration:** Indeterminate 1998—99  
**Contact:** John C. Monn, (717) 772-8197

**ADV No. 34** Indiana University of Pennsylvania (IUP) is seeking bids for Networking Products for the Technology Services Center campus-wide data networking installations. Acceptable manufacturer: 3COM Products must work with existing Network Management System at IUP. Requests for a bid package should be made, in writing, referencing Advertisement No. 34 and directed to Patty Bash, Purchasing Agent, IUP, 650 South 13th Street, Robertshaw Building, Indiana, PA 15705, fax (724) 357-2670; phone (724) 357-3077; or e-mail: PABash@grove.iup.edu. Requests for bid packages will be accepted until July 2, 1999. The University encourages responses from small and disadvantaged, minority and women-owned firms.

**Department:** State System of Higher Education  
**Location:** Indiana University of Pennsylvania, Indiana, PA 15705  
**Duration:** Indeterminate 1998—99  
**Contact:** Patty Bash, (724) 357-3077

**X6076 and X6044** Provide Hewlett Packard and IBM Lexmark cartridges.

**Department:** Environmental Protection  
**Location:** Harrisburg, PA  
**Duration:** Should be delivered by August 5, 1999  
**Contact:** Dawn Levarto, (717) 787-9645

**8960-2500-000** The contractor shall supply approximately 200,000 gallons of portable water on an as needed basis during the drought season. The anticipated period of water supplies is July 1, 1999 through December 31, 1999. To obtain a copy of the bid call Diane Davis at (814) 378-1006.

**Department:** Corrections  
**Location:** State Correctional Institution Houtzdale, State Route 2007, P. O. Box 1000, Houtzdale, PA 16698-1000  
**Duration:** July 1, 1999 through December 31, 1999  
**Contact:** Diane K. Davis, (814) 378-1006

**FL-260034** Labels, direct thermal, fan fold, blank.

**Department:** Liquor Control Board

**Location:** Liquor Control Board, 8201 Enterprise Avenue, Philadelphia, PA 19153; Liquor Control Board, Papercraft Building, Papercraft Park, Pittsburgh, PA 15238; Liquor Control Board, Stauffer Industrial Park, 1 Kane Lane, Taylor, PA 18517

**Duration:** Approximately 1 year (Deliver 32 boxes every other month per location)

**Contact:** Betty J. Goodling, (717) 787-6360

---

**KURFP 0006:** Kutztown University is seeking to solicit proposals from vendors capable of supplying monographs and other library materials for an undergraduate library collection. Those firms interested in receiving an RFP package must request it in writing and direct it to: Barbara Reitz, Director of Purchasing, Kutztown University, Kutztown, PA 19530, phone (610) 683-4132; fax (610) 683-4674 or e-mail: reitz@kutztown.edu. RFP packages will be available July 6, 1999. Questions requiring clarifications prior to proposal submission must be submitted by July 20, 1999. Proposals are due by 2 p.m. on July 29, 1999.

**Department:** State System of Higher Education

**Location:** Kutztown University, Kutztown, PA 19530

**Duration:** One year after notice to proceed with option to renew for 4 additional one year terms

**Contact:** Barbara Reitz, (610) 683-4132

[Pa.B. Doc. No. 99-1080. Filed for public inspection July 2, 1999, 9:00 a.m.]

---

## DESCRIPTION OF LEGEND

---

- |  |   |
|--|---|
| <p><b>1</b> Advertising, Public Relations, Promotional Materials</p> <p><b>2</b> Agricultural Services, Livestock, Equipment, Supplies &amp; Repairs: Farming Equipment Rental &amp; Repair, Crop Harvesting &amp; Dusting, Animal Feed, etc.</p> <p><b>3</b> Auctioneer Services</p> <p><b>4</b> Audio/Video, Telecommunications Services, Equipment Rental &amp; Repair</p> <p><b>5</b> Barber/Cosmetology Services &amp; Equipment</p> <p><b>6</b> Cartography Services</p> <p><b>7</b> Child Care</p> <p><b>8</b> Computer Related Services &amp; Equipment Repair: Equipment Rental/Lease, Programming, Data Entry, Payroll Services, Consulting</p> <p><b>9</b> Construction &amp; Construction Maintenance: Buildings, Highways, Roads, Asphalt Paving, Bridges, Culverts, Welding, Resurfacing, etc.</p> <p><b>10</b> Court Reporting &amp; Stenography Services</p> <p><b>11</b> Demolition—Structural Only</p> <p><b>12</b> Drafting &amp; Design Services</p> <p><b>13</b> Elevator Maintenance</p> <p><b>14</b> Engineering Services &amp; Consultation: Geologic, Civil, Mechanical, Electrical, Solar &amp; Surveying</p> <p><b>15</b> Environmental Maintenance Services: Well Drilling, Mine Reclamation, Core &amp; Exploratory Drilling, Stream Rehabilitation Projects and Installation Services</p> <p><b>16</b> Extermination Services</p> <p><b>17</b> Financial &amp; Insurance Consulting &amp; Services</p> <p><b>18</b> Firefighting Services</p> <p><b>19</b> Food</p> <p><b>20</b> Fuel Related Services, Equipment &amp; Maintenance to Include Weighing Station Equipment, Underground &amp; Above Storage Tanks</p> <p><b>21</b> Hazardous Material Services: Abatement, Disposal, Removal, Transportation &amp; Consultation</p> | <p><b>22</b> Heating, Ventilation, Air Conditioning, Electrical, Plumbing, Refrigeration Services, Equipment Rental &amp; Repair</p> <p><b>23</b> Janitorial Services &amp; Supply Rental: Interior</p> <p><b>24</b> Laboratory Services, Maintenance &amp; Consulting</p> <p><b>25</b> Laundry/Dry Cleaning &amp; Linen/Uniform Rental</p> <p><b>26</b> Legal Services &amp; Consultation</p> <p><b>27</b> Lodging/Meeting Facilities</p> <p><b>28</b> Mailing Services</p> <p><b>29</b> Medical Services, Equipment Rental and Repairs &amp; Consultation</p> <p><b>30</b> Moving Services</p> <p><b>31</b> Personnel, Temporary</p> <p><b>32</b> Photography Services (includes aerial)</p> <p><b>33</b> Property Maintenance &amp; Renovation—Interior &amp; Exterior: Painting, Restoration, Carpentry Services, Snow Removal, General Landscaping (Mowing, Tree Pruning &amp; Planting, etc.)</p> <p><b>34</b> Railroad/Airline Related Services, Equipment &amp; Repair</p> <p><b>35</b> Real Estate Services—Appraisals &amp; Rentals</p> <p><b>36</b> Sanitation—Non-Hazardous Removal, Disposal &amp; Transportation (Includes Chemical Toilets)</p> <p><b>37</b> Security Services &amp; Equipment—Armed Guards, Investigative Services &amp; Security Systems</p> <p><b>38</b> Vehicle, Heavy Equipment &amp; Powered Machinery Services, Maintenance, Rental, Repair &amp; Renovation (Includes ADA Improvements)</p> <p><b>39</b> Miscellaneous: This category is intended for listing all bids, announcements not applicable to the above categories</p> |
|--|---|

GARY E. CROWELL,  
*Secretary*

## Contract Awards

The following awards have been made by the Department of General Services, Bureau of Purchases:

Requisition or Contract #	Awarded On	To	In the Amount Of
5680-01	07/01/99	Crafco, Inc.	941,308.00
5680-01	07/01/99	McAsphalt Industries, Ltd.	72,666.00
6530-03	06/23/99	Delcrest Medical Co.	7,998.00
6530-03	06/23/99	Dick's Homecare, Inc.	5,332.00
6530-03	06/23/99	Jordan-Reses Home Health Care	165,292.00
6530-03	06/23/99	Youngs Medical Equip.	2,666.00
6760-02	06/23/99	Bell and Howell Co.	10,000.00
6760-02	06/23/99	Commonwealth Office Systems, Inc.	15,000.00
6760-02	06/23/99	Universal Imaging Conversions	50,000.00
6760-02	06/23/99	National Commercial Envelope Co.	10,000.00
6760-02	06/23/99	IMR, Ltd.	362,000.00
6760-02	06/23/99	Anacomp, Inc.	391,600.00
7920-07	06/25/99	Industrial Soap Co.	21,366.50
7920-07	06/25/99	Penn Jersey Paper Co.	29,787.44
8960-01	07/01/99	Crystal Spring Water Co.	213,540.00
9905-08	07/01/99	Detronics Limited	77,950.00
9905-08	07/01/99	Eastern Metal, Inc.	353,775.25
1020159-01	06/22/99	B & H Photo Video, Inc.	32,235.00
1029169-01	06/22/99	Pro Com Systems	84,059.00
1581218-01	06/22/99	Shirn's Pontiac GMC, Inc.	26,681.00
1621228-01	06/22/99	Water Management Tech, Inc.	40,680.00

Requisition or Contract #	Awarded On	To	In the Amount Of
1625118-01	06/22/99	Pinnacle Electronics Systems	76,200.00
1657118-01	06/22/99	Global Surveillance Associates, Inc.	80,404.00
1667118-01	06/22/99	Pinnacle Electronic Systems	89,780.00
1673218-01	06/22/99	Rohrer Bus Sales	37,500.00
1684168-01	06/22/99	Advanced Training Systems, Inc.	55,332.00
1687118-01	06/22/99	Intoximeters, Inc.	1,677,500.00
1694208-01	06/22/99	L. A. Goodnow Co., Inc. dba/New Eagle International	33,900.00
1715118-01	06/22/99	Lindgren Corp.	35,200.00
1719388-01	06/22/99	Advance Canvas Design	22,175.00
1727158-01	06/22/99	Shirn's Pontiac GMC, Inc.	46,810.00
1750358-01	06/22/99	Atlantic Nuclear Corp.	27,133.00
1751358-01	06/22/99	Horizon Technology	114,630.00
1759388-01	06/22/99	Rorabaugh Lumber Co.	111,380.00
1760048-01	06/22/99	W. W. Manufacturing Co., Inc.	162,525.00
7314190-01	06/22/99	Mid-Atlantic Flooring Co., Inc.	80,775.00
7314230-01	06/22/99	XPEDX	197,280.00
8112860-01	06/22/99	Brechbuhler Scales, Inc.	207,500.00
8141440-01	06/22/99	Dunbar Asphalt Products, Inc.	226,284.00

GARY E. CROWELL,  
Secretary

[Pa.B. Doc. No. 99-1081. Filed for public inspection July 2, 1999, 9:00 a.m.]



# RULES AND REGULATIONS

## Title 55—PUBLIC WELFARE

### DEPARTMENT OF PUBLIC WELFARE

#### [55 PA. CODE CHS. 3480 AND 3490]

#### Protective Services

##### *Statutory Authority*

The following amendments are adopted in Annex A under the authority of Articles VII and IX of the Public Welfare Code (62 P. S. §§ 701—774 and 901—922); 42 Pa.C.S. §§ 6301—6365 (relating to the Juvenile Act); section 2168 of the County Code (16 P. S. § 2168); section 405 of the County Institution District Law (62 P. S. § 2305); and 23 Pa.C.S. §§ 6301—6385 (relating to the Child Protective Services Law) (CPSL).

Notice of proposed rulemaking was published at 28 Pa.B. 1079 (February 21, 1998).

##### *Purpose of Amendments*

It is the purpose of Chapter 3490 (relating to protective services) to:

- Encourage more complete reporting of suspected child abuse; to involve law enforcement agencies, as permitted by this chapter, in responding to child abuse; and to establish protective services in each county, for the purpose of investigating reports swiftly and competently.
- Protect children from further abuse and provide rehabilitative services for children and parents involved so as to ensure the child's well-being and to preserve, stabilize and protect the integrity of family life wherever appropriate.
- Ensure that each county children and youth agency establishes a program of general protective services for children; to assess the risk of harm to a child and respond adequately to meet the needs of families and children who may be at risk and to prioritize the response and services to children most at risk.
- Provide for investigations of reports of suspected abuse of students by school employes and screen applicants for employment in schools to determine whether or not the applicant has a prior history of abusing children. The requirement to screen applicants for employment in schools is a new requirement and is in addition to the requirement to screen applicants for employment in child care agencies.
- Establish a training and certification program for all county children and youth agency staff who provide direct services to children who need protective services and for persons who supervise direct service workers.

##### *Need for Amendments*

These amendments are needed to implement the act of December 16, 1994 (P. L. 1286, No. 151) (Act 151) and Act 10 of 1995 Special Session (SS1), to clarify and amend existing regulations and to rescind Chapter 3480 (relating to child protective services—general).

##### *Requirements*

a. Section 3490.4 (relating to definitions) adopts the CPSL definition of "child abuse" in the regulations to:

1. Require the county children and youth agencies to investigate recent reports of suspected serious physical

injury, and reports of imminent serious physical injury or sexual abuse or exploitation that are reported within two years of the date the alleged abuse occurred.

2. Include situations of imminent risk of serious physical injury and sexual abuse or exploitation of a child. This amendment seeks to prevent the abuse of children where there is a high probability of abuse.

3. Require mandated reporters to make a report of suspected child abuse when they have reasonable cause to suspect, on the basis of their medical, professional or other training and experience, that a child coming before them in their professional or official capacity is an abused child. The standard of when they are mandated to report has been changed from "reasonable cause to believe" to "reasonable cause to suspect."

b. Section 3490.34 (relating to pending complaint file) adopts the CPSL requirement that unfounded reports are expunged from the State and county files within 120-calendar days from when the report was received at ChildLine. Founded and indicated reports are expunged from the Statewide Central Register when the child turns 23 years of age. However, except for the identity of the child, information on founded and indicated reports of child abuse and student abuse are maintained indefinitely when the Social Security Number or date of birth of the perpetrator of child abuse or the school employe who abused the student is known.

c. Section 3490.39 (relating to expunction from the Statewide Central Register) adopts the CPSL requirement for the Department to establish a subfile of the names of perpetrators of indicated and founded reports of child abuse and student abuse in the Statewide Central Register when the Social Security Number or date of birth of the person responsible for the abuse is known. These reports remain on file indefinitely.

d. Section 3490.56 (relating to the county agency investigation of suspected child abuse perpetrated by persons employed or supervised by child-care services and residential facilities) adopts the CPSL requirement that child-care agencies and residential facilities develop and implement a plan of supervision or make alternative employment arrangements for the individual under investigation as the alleged perpetrator when the child is allegedly abused by an employe of the agency or facility. The plan shall be approved by the county agency.

e. Sections 3490.61 and 3490.235 (relating to supervisory review and child contacts; and services available through the county agency for children in need of general protective services) require the county agency supervisor to review reports of suspected abuse that are under investigation and reports that are being assessed to determine the need for general protective services to ensure the safety of the child and the progress made toward reaching a status determination. These sections also require the county agency to assure that contacts are made with the child and parents as often as necessary for the protection of the child but no less often than once a week when the child is in a high-risk status.

f. Section 3490.105(a) (relating to request by a perpetrator to amend or expunge an indicated report of child abuse received by ChildLine after June 30, 1995) adopts the CPSL requirement that perpetrators named in indi-

cated reports of child abuse who seek to have the report amended or expunged to request the Secretary of the Department of Public Welfare (Department) to amend or expunge the report within 45-calendar days of the mailing date of the notice from ChildLine.

g. Section 3490.108 (relating to cooperation of county agencies and law enforcement agencies) adopts the CPSL requirement that county agencies and law enforcement officials shall, to the extent permitted by law, cooperate and coordinate their investigations of reports of suspected child abuse. The CPSL was amended to require county agencies to report certain types of child abuse to law enforcement officials.

h. Section 3490.109 (relating to report from law enforcement agencies) adopts the CPSL requirement that law enforcement agencies shall notify the county agency if a criminal investigation has been undertaken and the results of the investigation and prosecution of child abuse reports referred to them by the county agency. Prior to Act 151, county agencies were required to notify law enforcement officials of certain instances of suspected child abuse. However, there was no requirement for law enforcement officials to notify the county agency of the results of the referrals.

i. Sections 3490.131—3490.137 (relating to verification of the existence of child abuse and student abuse records for school employes) adopt the CPSL requirements that administrators of schools require all applicants for positions as school employes, including independent contractors and their employes who have contact with children, to submit a clearance statement from the Statewide Central Register. The Statewide Central Register is the State repository of all founded and indicated reports of child abuse and student abuse. A clearance determines if the applicant's name is on file as a perpetrator of child abuse or student abuse. An administrator or independent contractor of a school may not hire an applicant if the applicant is a perpetrator named in a founded report of child abuse or student abuse.

j. Sectopms 3490.141—3490.143, Subchapter B (relating to abuse of students in school) adopts the requirements of the CPSL regarding reporting and investigating reports of suspected serious bodily injury or sexual abuse or exploitation of a student by a school employe. School administrators are required to report suspected student abuse to the district attorney and local law enforcement officials. The law enforcement official is required to investigate the allegation and to report the suspected student abuse to the county agency if the official has reasonable cause to suspect that the child was abused by a school employe. The county agency is required to investigate the report to determine whether the report is a founded, indicated or unfounded report of student abuse.

k. Section 3490.192 (relating to request for a hearing from a school employe for indicated reports of student abuse) adopts the CPSL requirement that a person responsible for the abuse in an indicated report of student abuse has the right to request the Secretary of the Department to amend or expunge the report within 45-calendar days of the mailing date of the notice from ChildLine.

l. Sections 3490.201—3490.242 Subchapter C (relating to general protective services) adopts the CPSL requirement that each county agency must administer a program of general protective services for children who have been assessed as needing the services to prevent abuse, neglect

and exploitation. The goal of general protective services is to: keep children safely in their own homes when possible; overcome problems that result in dependency; provide temporary substitute care; reunite children safely with their families, whenever possible, when children have been placed in out-of-home care; provide permanent legally assured homes for children who cannot return home; and provide services for children adjudicated dependent in section 6341 of the Juvenile Act (relating to adjudication).

General protective services are defined as "services to prevent the potential for harm to a child." A definition of "potential for harm" was added for clarity. It is defined as: "likely, if permitted to continue, to have a detrimental effect on the child's health, development or functioning." The term does not include imminent risk as defined in the definition of "child abuse" in § 3490.4.

This subchapter requires county agencies to receive and assess reports of children alleged to be in need of general protective services. The subchapter establishes those services that county agencies shall have available for children in need of general protective services and their families both during and after the assessment. It establishes recordkeeping procedures and procedures for notifying persons named in reports alleging the need for general protective services. It provides procedures for persons to appeal the decision of the agency to provide services to the child and family. Previously, county agencies provided general protective services under Chapter 3480. This rulemaking rescinds Chapter 3480.

m. Sections 3490.311—3490.314 (relating to staff orientation, training and certification requirements) adopt the requirement of the CPSL that the Department establish a training and certification program for county agency staff who provide direct services. County staff who had regular employment status on June 30, 1996, were grandfathered in and not required to complete any of the required training courses. Staff hired on or after July 1, 1996, are required to complete 120 hours of CORE training and be recommended by the person's supervisor for certification. Staff who are not certified as direct service workers may not provide protective services. The regulations also require annual training for direct service workers. The certification requirements will ensure that all direct service workers have met minimum training requirements and have been approved by the county agency as certified direct service workers.

Section 3490.314 (relating to training and certification requirements for supervisors who supervise direct service workers) requires persons who supervise direct service workers to complete a supervisory training program which is approved by the Department in consultation with a steering committee composed of State and county staff.

n. Sections 3490.321 and 3490.322, Subchapter D (relating to risk assessment) adopt the CPSL requirement that the Department and the county agencies establish a State-approved risk assessment process to aid in determining the amount of risk to a child if the child remains in the child's own home or is returned home from placement. The county agencies began using a single State-approved risk assessment process on July 1, 1997.

o. Section 3490.361 (relating to requirement for agencies providing protective services) was added by the Department to require private agencies providing protective services arranged by the county agency to comply with §§ 3130.21(4), 3130.39 and 3130.40 (relating to

responsibilities of county executive officers; services and facilities which may be used; and delivery of services through other service providers) to assure that children covered by the CPSL and this chapter receive services provided by agencies and facilities licensed by the Department.

p. Section 3490.362 (relating to licensure requirements for persons providing services arranged or provided by the county agency) requires professional persons providing services to abused and neglected children to have a valid license issued by the Department of State when their profession is subject to mandatory licensure.

q. Section 3490.401 (relating to intercounty transfer of cases) contains requirements relating to the transfer of information from one county to another county when the child or parents move to another county and the case is being investigated for suspected child abuse, being assessed for general protective services or was previously accepted by a county agency for protective services.

#### *Affected Individuals and Organizations*

The amendments will affect children and youth and their families, as well as, public and private children and youth agencies, law enforcement officials, school employees and persons whose employment, occupation or practice of their profession bring them into direct contact with children, and persons seeking employment in a child-care service.

#### *Accomplishments/Benefits*

All children deserve to grow up in safe, nurturing homes. Sadly, many are victims of child abuse and neglect. It is a problem that has devastating effects on children and families in this Commonwealth. While substantial progress has been made in addressing this problem, the Department continues to look for ways to improve the program. This rulemaking has addressed issues and remedies identified by the Legislature, the Department, county agencies and other practitioners in implementing the CPSL since its enactment on November 26, 1975, and amendments enacted December 16, 1994.

The Department has found that the development of a quality children and youth work force is critical to the child protection program in this Commonwealth. This rulemaking addresses that issue. As required by the CPSL, this rulemaking provides for initial and ongoing training and certification of all county personnel providing protective services for children. Persons who are not certified may not perform these functions.

Additionally, caseworkers need adequate and appropriate tools to do the job. As required by the CPSL, this rulemaking has established requirements for the State-wide implementation of a State-approved risk assessment process. This process shall be used in every investigation or assessment made by county protective service workers and at least every 6 months thereafter. Assessments are also required when a child is being returned home and within 30 days prior to closing the case.

The risk assessment process is not a substitute for education, experience, training, supervision or good judgment. It is an important tool that assures uniform application of validated criteria as an aid in decision making. Likewise, it shall be used to inform agency planning when children may be at risk of further abuse. To this end, these final rules have established a requirement that case plans for children in need of protective services reflect the level of risk determined by the county

agency for each case. Supervisory oversight of this requirement has been established by these final rules.

An effective child protection program provides for frequent contact with children who are at high risk of abuse by caseworkers assigned responsibility for these cases. Recent inquiries into tragic child deaths in this Commonwealth by the General Assembly and the Department have documented the need for this contact. To that end, this rulemaking has established a requirement that children be seen as often as necessary for their protection but at least once a week as long as they remain at high risk of abuse. The Department contends this requirement will further assure the safety of children in this Commonwealth. It is also an existing practice by many counties. These contacts may be made by county agency caseworkers or by persons under contract with county agencies.

The Commonwealth child protection program cannot assure that children will always be safe, but it must be vigilant in protecting children from repeated abuse. In response to comments received, this rulemaking has raised the threshold of intervention for repeated cases of child abuse by requiring multidisciplinary team reviews if a child has been the victim of one substantiated incident of child abuse and the receipt of a subsequent report of suspected child abuse rather than the prior requirement of three these reports. This requirement affirms that child protection is not just a function of county agencies but shall be addressed by the broader community.

The CPSL provides for the sharing of case information among county agencies. This rulemaking has further implemented this provision of the CPSL by requiring information sharing and cooperation between counties. The need for information sharing and cooperation between counties arises when families with children in need of protection move across county lines, sometimes to avoid detection. In other instances, the subjects of reports may reside in multiple counties and cooperation is needed to complete investigations/assessments. This rulemaking has provided procedures for counties to follow when families move from one county to another, whether or not a specific new address of the family is known. These final rules also require accommodation by all counties of requests by those counties assigned responsibility for completion of investigations of reports of suspected child abuse or assessments of the need for general protective services. Cooperation across county lines is critical to the protection of children and cannot be simply left to negotiation between counties.

The amendments to the CPSL, by Act 151 for the first time, established a program of general protective services in State law. The CPSL requires that the Department define "general protective services" by regulation. The Department's proposed definition of "general protective services" includes activities and services arranged or provided, or both, for neglected children. This rulemaking has been revised to clarify the definition of "general protective services" to be consistent with the broad purpose of the CPSL to protect the rights, welfare and safety of children so that they have the opportunity for healthy growth and development and to assist parents in recognizing and remedying conditions harmful to their child and in fulfilling their parental duties in a manner that does not put the child at risk. This clarification is a recognition that children may be at risk, not only as a result of the acts or failure to act of their parents, but also because of their own behavior. The definition of general protective services is clarified to acknowledge conditions leading to dependency as defined by the Juve-

nile Act. Alleviation of these conditions is included as necessary to provide essential care for children and assist parents with issues involving truancy and ungovernability. County agency assistance may be required to correct these conditions before seeking an adjudication of dependency.

General protective services are critical in preventing cases from escalating to serious child abuse, dependency or delinquency. Success with these services results in less intrusive and less costly services.

The Department has incorporated other important revisions directly from the CPSL into this rulemaking. These revisions are already a matter of public policy and the Department has added them to establish context and continuity in this rulemaking. These provisions included expanding the definition of "child abuse" to include imminent risk of abuse; requirements relating to abuse of students in schools; and requirements relating to the reporting of suspected child abuse.

#### *Public Comments*

Written comments, suggestions and objections were solicited within a 30-day period after the publication date.

#### *Discussion of Comments*

#### *Major Comments*

##### *§ 3490.43. Issuance of bulletins.*

*Comment:* Seven commentators, including the Independent Regulatory Review Commission (IRRC), requested clarification related to the issuance of bulletins for the dissemination of practice standards; several inquired if implementation of these standards would be mandatory and binding. Requests were made for inclusion of the standards in regulation and the need for advance notification with the opportunity for public comment. Several commentators stated that these standards should not be implemented as a result of performance audits in specific counties but across this Commonwealth.

*Response:* The Department deleted the section referencing issuance of bulletins. The Department has the authority to issue statements of policy to communicate policy, including the interpretation of regulation, through the issuance of bulletins in accordance with § 9.12 (relating to statements of policy). The Department, in conjunction with the Pennsylvania children and youth administrators, is developing practice standards to strengthen the child welfare system throughout this Commonwealth. These standards will be made available to county agencies to improve the quality of services to children and families and exceed the requirements of these regulations. The Department will incorporate these practice standards in the training program. The Department expects the development of these standards to be completed by July 1999. Statewide distribution and training would begin with implementation in the year 2000.

Section 6343(b) of the CPSL (relating to investigating performance of county agency) grants the Secretary or a designee the power to direct a performance audit of any activity engaged in under the CPSL. Specific action necessary to correct a condition identified as a result of a finding in a performance audit will be shared with the county agency to fulfill the Department's and the county agency's duties under the legal base at § 3490.3 (relating to legal base). The Department will assure compliance with any recommendations made to the county agency which will improve child safety and protection.

##### *§ 3490.61. Supervisory review and child contacts.*

*Comment:* Six commentators, including IRRC, raised concern related to the fiscal impact associated with weekly contact with children who are deemed at high risk of abuse. Several requested clarification specifying who is required to make these contacts. Commentators also raised concern related to caseload size and the inability to meet these increased demands. Several commentators requested statistics on the number of high-risk children identified within this Commonwealth.

*Response:* The Department reviewed the comments and amended the section to provide clarification that the county agency will assure that the child is seen either directly by the worker or through a purchase of service. Children who are at high risk of abuse or neglect must be seen once a week to assure the safety of the child and that the level of services provided to children and families should be consistent with the level of risk to the child. This section could result in some increased fiscal demands for those county agencies where this is not a current practice. The county agency is required to see the child no less than every 180-days to fulfill its case management responsibilities. Child safety is paramount. County agencies through the needs-based budget process may request additional resources for the implementation of this section. The cost to implement this section will be based on the existing level of service already being provided to high-risk children. It is expected that some county agencies are already attempting to meet this standard.

The number of high-risk children throughout this Commonwealth would be difficult to project given that the current nature of these reports and the number of children changes frequently.

##### *§ 3490.223. Definitions.*

*Comment:* Seven commentators, including IRRC, raised concern related to the definition of "general protective services" as the focus was limited to neglect. Several commentators requested the inclusion of services to children who are truant and ungovernable as defined by the Juvenile Act. One commentator requested clarification of the difference between the definition of neglect as defined in general protective services and neglect as defined relating to child abuse.

*Response:* The Department reviewed the comments and considered the need for a definition of "general protective services" which clarifies the broad purposes of the subchapter. There are two purposes in § 3490.222 (relating to purpose): to protect the rights, welfare and safety of children so that they have an opportunity for healthy growth and development; and to assist parents in recognizing and remedying conditions harmful to their child and in fulfilling their parental duties in a manner that does not put the child at risk. To effect these purposes, the Department made changes to acknowledge that without intervention these conditions could lead to dependency as defined by the Juvenile Act. Conditions, including truancy and ungovernability, should be assessed and if identified would make a child eligible for general protective services. The correction of these conditions is necessary to provide essential care for children and to assist parents.

The addition of a definition of "potential for harm" clarifies the definition of "general protective services," requiring that general protective services are needed because without this intervention, a detrimental effect on the child's health, development or functioning is likely.

Provision of general protective services will also prevent cases from escalating to reports of child abuse.

*§ 3490.401. Intercountry transfer of cases.*

*Comment:* Four commentators, including IRRC, recommended the inclusion of regulatory language which provides detailed requirements when a family moves to another county and there is no specific address for the family. Commentators raised concern that the section as proposed did not adequately protect children.

*Response:* The Department concluded that the additional requirements will aid in the protection of children. The Department included language which provides requirements for both the referring county and the receiving county when the family's address is unknown. The provision requires both the referring and receiving agency make attempts to locate the family. There must be contact with the agencies who may have knowledge of the family's location. The Department enumerated persons and entities who shall be contacted including schools, post offices, medical personnel, county assistance offices and persons who are known to have knowledge of the family. High-risk children shall be seen within 24 hours at their new residence to assess the current level of risk. The Department requires communication between county agencies and notification by the receiving county to the referring county of the attempts made to locate the family and the status of the investigation.

*Discussion of comments:*

*Protective Services  
Introduction*

*§ 3490.4. Definitions.*

*Comment:* IRRC requested an explanation of the decision making process when accepting cases for service. Another commentator recommended the regulations include accept for service criteria.

*Response:* Child welfare in this Commonwealth is a county-administered system. The determination of service provision at the county level may not fall below State and Federal statutes and regulations. The definition of "accept for service" is the threshold that indicates when a county agency determines that involvement with a family is warranted based on the level of risk and the potential for harm to a child.

*Comment:* Commentators, including IRRC, requested clarification regarding the inclusion of the clinical nurse specialist (CNS) and the registered nurse in the definition of "certified medical practitioner."

*Response:* The Department amended the definition of "certified medical practitioner" to include a licensed physician's assistant and a certified registered nurse practitioner (CRNP), however, declined to include CNSs. This decision was based on the fact that CNSs are not certified by the Commonwealth. CRNPs are licensed as registered nurses and certified by the State Board of Nursing under the regulations jointly promulgated by the State Boards of Nursing and Medicine.

*Comment:* Several commentators raised concern regarding the deletion of the definitions of "organized church" or "religious denomination" in the definition of "child abuse." Persons may not be deemed as perpetrators of child abuse if they have withheld medical or surgical care as a result of religious beliefs consistent with a bona fide religion. One commentator failed to recognize the deletion of the definitions of "recognized church" or

"religious denomination" and commended the Department for including the clarification.

*Response:* The Department deleted the definitions of "recognized church" or "religious denomination" as recognized for tax purposes by the United States Internal Revenue Service because there are a number of groups who are otherwise bona fide whose religious doctrine precludes them from obtaining Internal Revenue Service certification. The Department did not further clarify the definition of "bona fide religion" so as not to exclude any form of recognized religion. Religious beliefs are potentially so very diverse as to preclude necessary and sufficient criteria.

*Comment:* One commentator viewed the definition of "ChildLine" as a clerical function with the purpose of receiving and maintaining reports and questioned the authority of ChildLine workers to assign reports if the county agency does not feel that the allegations meet the definition for a child protective services investigation.

*Response:* The Department made no functional changes to the definition of "ChildLine." In the proposed rulemaking, the definition of "ChildLine" was modified to include receipt of reports of student abuse.

*Comment:* One commentator raised concern related to the reference of the Department supervising the county agency. The commentator suggested that the word "supervised" be changed to "monitored" in the definition of "county agency."

*Response:* The Department adopted the statutory definition of "county agency."

*Comment:* IRRC suggested the Department use the statutory definition of "deviate sexual intercourse" as the current regulatory definition differs from the statute.

*Response:* The Department adopted the statutory definition of "deviate sexual intercourse."

*Comment:* IRRC raised concern regarding the difference between the regulatory and statutory definition of "forcible compulsion."

*Response:* The Department deleted the definition of "forcible compulsion" from the section because the term is no longer used in the chapter.

*Comment:* IRRC raised concern that the definition of a "founded report" differed from the statutory definition.

*Response:* The Department adopted the statutory definition of "founded report."

*Comment:* IRRC noted that the definition of "indicated report" differs from the statutory definition.

*Response:* The Department adopted the statutory definition of "indicated report."

*Comment:* Two commentators, including IRRC, raised concern regarding the definition of "individual residing in the same home as the child." IRRC commented the definition deviates from the statute while the second commentator requested time frames be provided to define "residency."

*Response:* The Department adopted the statutory definition of "individual residing in the same household as the child."

*Comment:* One commentator expected further clarification of the definition of "imminent risk" and was concerned about the lack of regulation when other areas appear strictly regulated.

*Response:* The Department considered the comment but did not change the definition. The Department provides training to county agency workers through the certification of direct service workers. The Department intends to reconvene a task force to address issues related to imminent risk and will provide further guidance through the training program.

*Comment:* IRRC advised that the definition of "person responsible for a child's welfare" differs from the statutory definition.

*Response:* The Department adopted the statutory definition of "person responsible for a child's welfare."

*Comment:* IRRC commented that the definition of "protective services" differs from the statutory definition.

*Response:* The Department adopted the statutory definition of "protective services."

*Comment:* IRRC advised that the definition of "required reporter" differs from the statutory definition. One commentator offered to aid the Department by informing those required reporters in their department of the change from reasonable cause to believe to reasonable cause to suspect that a child has been abused.

*Response:* The Department added optometrist to the list of those persons required to report as this was inadvertently deleted from the section. The Department added psychologist to the enumeration of those required to report abuse as a clarification of mental health professional. Psychologists frequently conduct evaluations of children and parents which are used by the county agency in determining the need for services and the most appropriate modality for treatment.

*Comment:* IRRC commented that the definition of "serious mental injury" differs from the statutory definition. Another commentator further suggested that CNSs be given the ability to diagnose serious mental injury rather than limiting it to a physician or licensed psychologist.

*Response:* The Department adopted the statutory definition of "serious mental injury." The Department cannot include CNSs as the statute limits those authorized to determine serious mental injury to physicians and licensed psychologists.

*Comment:* IRRC commented that the definition of "serious physical injury" deviates from the statutory definition.

*Response:* The Department adopted the statutory definition of "serious physical injury."

*Comment:* IRRC supported the use of the statutory definition of "sexual abuse" as the regulatory definition deviates from the statutory definition. One commentator suggested that language be added to clarify that acts by the perpetrator that are committed for the purpose of sexual gratification should include those that cannot be reasonably explained except for the purpose of sexual gratification. This would aid in the ability to substantiate reports as sexual gratification can be difficult to prove.

*Response:* The Department adopted the definitions from 18 Pa.C.S. (relating to Crimes Code) when applicable. In addition, the Department clarified the terms "sexual abuse" and "exploitation."

*Comment:* IRRC advised that the term "sexual exploitation" is used in the chapter; however, it is not defined. It recommended the use of the statutory definition and that the term be used consistently in the chapter.

*Response:* The Department deleted references to sexual exploitation except from the definition of "child abuse." The term "exploitation" is included under the definition of "sexual abuse."

*Comment:* One commentator requested that a definition of "student" be added so that persons are able to differentiate between student abuse and child abuse throughout the chapter.

*Response:* The Department defined "student" in § 3490.143 (relating to definitions). This subchapter specifically pertains to student abuse. The definition of "student" was, therefore, not included in Subchapter A which specifically relates to child protective services.

*Comment:* IRRC suggested the Department use the statutory definition of "subject of the report."

*Response:* The Department adopted the statutory definition of "subject of the report."

*Comment:* One commentator suggested that the term "substantial evidence" be changed as it may be confusing and recommended conformance to case law. It recommended the definition be changed to "evidence which so preponderates in favor of a conclusion that it outweighs in the mind of a fact finder any inconsistent evidence and reasonable inference drawn." The commentator cited *Mortimore v. Pennsylvania Department of Public Welfare*, 697 A.2d 1031 (1993).

*Response:* The Department adopted the statutory definition of "substantial evidence." The decision in *Mortimore v. Pennsylvania Department of Public Welfare*, 697 A.2d 1031 (1993), predates amendments to section 6303 of the CPSL (relating to definitions).

*Comment:* IRRC commented that the definition of "unfounded report" differs from the statutory definition and recommended conforming to the statutory definition.

*Response:* The Department adopted the statutory definition of "unfounded report."

§ 3490.5. *Waivers.*

*Comment: Subsection (a).* IRRC noted that the language in this subsection is vague in that it does not provide guidance on the content of petitions, time frame for action, or where waiver requests are to be submitted. They recommended that specific provisions be included.

*Response:* The Department issued procedures for county agency waiver requests and will not include the specific procedural requirements in the regulation. These procedures are periodically subject to revision and are similar to other promulgated children and youth regulations.

*Comment: Subsection (b)(4).* IRRC concurred with one commentator who advised that the proposed rulemaking appears to allow the Department to authorize a violation of Federal statute or regulation or a State statute. They recommended that the language be amended to clearly state that the provision does not allow violation of either Federal or State statute or regulation.

*Response:* The Department did not intend to imply the Secretary could authorize violation of Federal statute or regulation or State statute. The Department made the recommended language change which does not allow granting waivers that violate or condone noncompliance with Federal statute or regulations or State statute.

*Comment: Subsections (b)(2) and (3) and (d)* use the term "agency." IRRC recommended using the term "county agency" to be consistent with the definitions.

*Response:* The Department adopted the term “county agency” throughout the regulation.

*Reporters*

§ 3490.11. *Reporting suspected child abuse.*

*Comment:* One commentator suggested that clarification be provided in this section to include language that persons, other than school employes, who suspect student abuse shall report the suspected student abuse to the school administrator as defined in § 3490.143.

*Response:* The Department included language that persons other than school employes, including independent contractors, who have reasonable cause to suspect student abuse shall report the suspected student abuse to the school administrator as required in §§ 3490.151(c) and 3490.152(a) and (b) (relating to required reporting; and responsibilities of administrators and school employes). The administrator does not have the authority to screen reports of suspected student abuse and shall immediately report the alleged student abuse to law enforcement officials and the appropriate district attorney as required by section 6352(a)(2) of the CPSL (relating to school employes).

§ 3490.13. *Reports by employes who are required reporters.*

*Comment:* Subsections (a) and (b). IRRC raised concern about the interim step for required reporters who are employed in an institution, school, facility or agency which requires notification to their superior of suspected abuse. The superior then notifies ChildLine. Section 6313 of the CPSL (relating to reporting procedure) does not require a mandated reporter to notify their superior; however, section 6352 of the CPSL does require school employes to notify the administrator regarding suspected student abuse. Confusion could result for required reporters who do not come under the definition of “school employe” under the statute. IRRC recommended that clarification be provided to clarify who shall report to an administrator. There was further concern noted that it would appear that two calls to ChildLine are required for one incident of suspected child abuse as § 3490.12 (relating to required reporters) requires the required reporter to call ChildLine.

*Response:* The Department added language to clarify that two calls to ChildLine are not mandatory. Section 6311(c) of the CPSL (relating to persons required to report suspected child abuse) requires staff of institutions, school, facilities or agencies to report cases of suspected child abuse to the person in charge. Two calls to report suspected child abuse may result if the reporter first provides the report to the county agency because required reporters are mandated to report to ChildLine. The requirements for reporting suspected student abuse to the administrator are provided in Subchapter B.

§ 3490.14. *Privileged communication.*

*Comment:* IRRC and one commentator noted that the exception to required reporters relating to confidential communications to members of the clergy was not included in the chapter. Additionally, IRRC suggested that the term “professional person” be changed to “required reporter.”

*Response:* The Department made the necessary change to the regulation which provides exemption of reporting confidential communications made to ordained members of the clergy. The Department changed the phrase “professional person required to report” to “required reporter.” The CPSL does not define “professional person.” Persons

who are not considered a professional person may be under confidentiality requirements, however are still required reporters as defined by section 6311 of the CPSL.

§ 3490.15. *Taking a child into protective custody.*

*Comment:* Subsection (a)(2). IRRC commented that the provision allowing a person designated specifically in writing by the director of a hospital or medical facility to take protective custody of a child to protect the child was omitted from regulation. Another commentator requested the inclusion of a certified clinical practitioner as a person authorized to take protective custody of a child.

*Response:* The Department amended the chapter to include the person designated by the director as a person authorized to take protective custody of a child. Certified clinical practitioners cannot be added to those enumerated as having the authority to take protective custody of a child. Section 6315 of the CPSL (relating to taking child into protective custody) does not include certified clinical practitioners as having the authority to take protective custody of a child unless designated by the director of the hospital or medical facility as having this authority.

§ 3490.17. *Notifying the child's parents, guardians or other custodians.*

*Comment:* Two commentators requested the ability to withhold the child's whereabouts from parents, guardians or other custodians absent a court order when providing this information would present a danger to the child or substitute caretaker.

*Response:* The Department considered the comment but did not change the section. This section relates to persons who take a child into protective custody and their need to notify the parent, guardian or other custodian of the child's whereabouts within 24 hours. The county agency does not have statutory authority to take protective custody of a child absent a court order and therefore would be excluded from this section. The county agency is required in section 6315(f) of the CPSL to convene a conference with the parent, guardian or other custodian of the child within 48 hours and provide information explaining the reasons for detention, as well as the child's whereabouts at that time. The county agency would need to include the request for withholding the child's whereabouts in an emergency placement petition to the court with the supporting rationale for withholding this information.

§ 3490.21. *Release of information on prior abuse reports.*

*Comment:* A commentator recommended expanding the enumeration of persons who may request information from the county agency on prior abuse involving the child being examined to include practitioners other than physicians.

*Response:* The Department amended the enumeration of persons who are authorized to request prior abuse information to include the person designated by the director of a hospital or medical facility. The Department cannot enlarge the statutory list. Information may be provided to these practitioners if they have been so designated by the director.

*Departmental Responsibilities*

§ 3490.31. *Receipt of reports.*

*Comment:* IRRC and another commentator questioned the Department's authority to refuse reports when persons are 18 years of age or older. The CPSL does not place a time limit on reports of serious mental injury, sexual abuse or serious physical neglect as long as the

incidents occurred when the person was under the age of 18. IRRC further recommended the language be changed to indicate that the Department already has established a Statewide toll-free number.

*Response:* The Department reviewed the comments and deleted the last sentence which would limit referrals to investigation of reports of suspected child abuse when the child was less than 18 years of age at the time of the report. The Department will implement the practice of receiving reports for incidents occurring when the child victim was 17 years of age or younger which are reported until the age of 20. This provision is consistent with statutory language mandating the investigation of recent acts for physical abuse and imminent risk. "Recent act" is defined in section 6303 of the CPSL as an act or omission that occurred within 2 years of the date of the report to the Department or the county agency. The Department will accept reports of sexual abuse, serious physical neglect and serious mental injury until the victim is age 20 without regard to the term "recent" as it is not found in section 6303(b) of the CPSL. The Department will refer persons over the age of 20 alleging child abuse to law enforcement officials. In making this decision, the Department relied on the purpose of section 6302(b) of the CPSL (relating to findings and purpose of chapter), which is designed to protect children, rehabilitate to ensure the child's well-being and to preserve, stabilize and protect the integrity of family life, whenever appropriate. The Department corrected the verb tense regarding the establishment of a Statewide toll-free number.

*§ 3490.32. ChildLine reporting to the county agency.*

*Comment:* IRRC and another commentator raised concern regarding the lack of guidance to county agencies when they are unable to agree upon who is responsible for cases of suspected child abuse. The lack of time frames for coordination while trying to meet the mandated time frames of seeing the child and completing the investigation may jeopardize child safety. As proposed, when county agencies are unable to agree who is responsible for the case, the regional office would resolve the difference. A commentator suggested that ChildLine make the determination of county agency responsibility. Another commentator requested the option of having responsibility for a report within their county when multiple counties are involved rather than just the county where the most recent suspected abuse occurred.

*Response:* The Department recognized the need for clarity regarding the involvement of numerous county agencies and included language to assure that investigations are completed within the time frames mandated at section 6368 of the CPSL (relating to investigation of reports). The Department accepted the suggestion that ChildLine determine the county agency responsible for investigation of reports when county agencies are unable to agree. ChildLine will continue to assign reports to multiple counties when there is more than one location of abuse if requested by a county agency. The county where the most recent incident occurred will have primary responsibility for investigation of the report.

The Department included language in § 3490.55(j) (relating to investigation of reports of suspected child abuse) which requires county agency cooperation to complete child abuse investigations. When the child and family are in a county other than the county responsible for the investigation of the report, the county where the subjects are located shall perform the duties of the investigation if requested by the county responsible for the investigation.

If a county agency seeks assistance from another county agency to complete an investigation, the agency shall assist as required by § 3490.55. This process is consistent with section 6334(a) of the CPSL (relating to disposition of complaints received) which requires cooperation.

*§ 3490.33. Files.*

*Comment:* A commentator requested that the Department clarify whether statistics in the annual Child Abuse Report include unfounded reports. The commentator also inquired if unfounded reports are reviewed during licensing inspections for the purpose of determining the reason the report was unfounded. The commentator advised that the question arises as a result of the difference in the rate of substantiation among county agencies.

*Response:* The annual Child Abuse Report prepared by the Department includes information relating to the number of unfounded reports received. However, a majority of the focus is on the substantiation of reports. The Department does review the decisions of the county agency in unfounded reports during the annual licensing inspection. The review is limited to those unfounded reports on file that are awaiting expunction.

*§ 3490.33. Files; 3490.34. Pending complaint file; 3490.35. Statewide Central Register.*

*Comment:* IRRC commented that these three sections discuss the same files; however, the discussion is broken into separate sections. This requires the reader to view two sections to understand the content of and procedures for pending complaint files and for the Statewide Central Register. IRRC recommended that the Department consider consolidation of these sections.

*Response:* The Department maintained the three separate sections to provide clarification of the purpose of each file. The files of the Department are subject to mandatory audit by the Attorney General to ensure these files are maintained appropriately and therefore a clear definition of each file is necessary.

*§ 3490.35. Statewide Central Register.*

*Comment:* IRRC and another commentator requested clarification of the reference to ChildLine entry of reports "if there is sufficient documentation to justify entry into the Statewide Central Register." Commentators were concerned that ChildLine would determine that reports would not be entered into the register if the Department determines that there is insufficient information.

*Response:* The Department reviewed the comments and amended the regulation to clarify the need for complete information in the Statewide Central Register. It is not the intent of the Department to change the determination of the county agency but to ensure the entry of complete information.

*§ 3490.40. Notifications regarding indicated reports.*

*Comment:* A commentator agreed that the change from "right to services" to "services available" from the county agency should result in a clearer articulation of the supportive services that a family can obtain; however, the family's right to services should not be diminished in light of the forthcoming changes in the "reasonable efforts" requirements under the Adoption and Safe Families Act (ASFA), Pub.L. No. 105-89 (amending Titles IV-B and IV-E of the Social Security Act). The notice should also be clear about the subject's right to service.

*Response:* The Department reviewed the comment and returned to the original language which provides notice to subjects of the report of their right to services.



§ 3490.42. *Performance audit and reviews.*

*Comment:* IRRC and numerous commentators requested the Department clearly define the required documentation and the reasons that would be acceptable in allowing child abuse reports to go beyond the 30-day time requirement.

*Response:* The Department considered the comment but did not change the regulation to provide a listing of reasons for exceeding the 30-day time requirement for child abuse reports. The Department cannot compile an inclusive listing and will provide direction through interpretive guidelines. Acceptable reasons for exceeding the 30-day time requirement would include awaiting the receipt of medical or psychological reports.

*County Responsibilities*

§ 3490.53. *Functions of the county agency for child protective services.*

*Comment:* One commentator questioned the language change from "deemed" to "determined" when referencing that no child may be determined to be abused based solely on injuries that result from environmental factors that are beyond the control of the person responsible for the child. The commentator believed that the statement indicated a higher standard for substantiation. Two commentators questioned the inclusion of this paragraph in that it was redundant. This portion of the definition of "child abuse" was included in the section while the remaining components of the definition were excluded.

*Response:* The Department reviewed the comments and deleted subsection (d).

§ 3490.54. *Independent investigation of reports.*

*Comment:* One commentator supported the provision allowing the county agency to rely on the law enforcement finding rather than conducting its own investigation which would reduce the need for multiple investigations and interviews.

*Response:* The Department considered the comment but did not change the section. The intent of the section is to enable county agencies to use the law enforcement investigation to support its finding when the allegations are substantially the same. It does not give the county agency the authority to not conduct an investigation. The first sentence of the section announces the requirement that the county agency conduct an investigation and make an independent determination. Section 6368(a) of the CPSL requires the county agency to immediately commence an appropriate investigation, see the child immediately if emergency protective custody is warranted or if safety cannot be determined, and to otherwise see the child within 24 hours. The Department supports cooperation and coordination between law enforcement officials and county children and youth agencies. The conducting of joint investigations and interviews will reduce both the number of interviews and the amount of trauma to children.

§ 3490.55. *Investigations of reports of suspected child abuse.*

*Comment:* IRRC and other commentators recommended the inclusion of the statutory provision requiring the county agency provide or arrange the services necessary to protect the child during the investigation period.

*Response:* The Department accepted the comment and amended § 3490.53(b) to include the provision of section 6368(a) of the CPSL which requires services be provided

or arranged during the investigation period when necessary to ensure the safety of the child.

*Issue:* Commentators raised concern with the requirement to conduct a home visit during a general protective service assessment when responding to § 3490.235 (relating to services available through the county agency for children in need of general protective services). During review of these comments, the Department noted no similar provision was required for child abuse investigations. The Department believes that to conduct a thorough child abuse investigation, the county agency must see the child and visit the child's home during the investigation period; therefore, this requirement has been included in the section. Although reports may not indicate a need to see the child's home, the county agency must assess the condition of the home to complete the risk assessment process. The Department further recognized that the presenting problem may not be an isolated issue and it is during the course of the investigation that the family dynamics are identified and evaluated.

*Comment:* One commentator suggested that the Department include language similar to that in § 3490.172 (relating to coordination of an investigation) that would require joint interviews for child abuse reports which is provided in reports of student abuse.

*Response:* The Department considered the comment but did not change the section. Section 6353.1(b)(2) of the CPSL (relating to investigation) states that law enforcement officials and the county agency shall conduct joint interviews of the student in reports of student abuse while section 6346(c) of the CPSL (relating to cooperation of other agencies) provides for cooperation and coordination to the fullest extent possible for cases of child abuse. The Department strongly encourages conducting joint interviews in cases involving child abuse, but the statute does not authorize the Department to require joint interviews.

*Comment: Subsection (a).* Two commentators questioned the need to see all children within 24 hours of the receipt of the report. Child abuse reports involving serious physical injury may be received based on allegations that occurred within 2 years and for sexual abuse, serious mental injury and serious physical neglect there is no statute of limitations. The perpetrators in these cases may no longer be involved with the family or the incident could have occurred several years ago. It is suggested that at those times when the victim is over the age of 18, that the victim need not be seen within 24 hours.

*Response:* The Department considered the comment but did not change the section. Section 6368(a) of the CPSL requires that all children be seen within 24 hours of the receipt of a report of alleged child abuse. The Department would not require the county agency to see a victim over the age of 18 within 24 hours. When there are indications that an alleged perpetrator of a report where the victim is over the age of 18 would have contact with a child as defined in § 3490.4, the Department requires the county agency see those minor children within 24 hours.

*Comment: Subsection (h).* Several commentators raised concern that needed medical examinations where serious physical injury is indicated have not been incorporated into the current needs-based budgets.

*Response:* The Department notified the county agencies of this requirement and the need to include costs associated with these medical examinations in their needs-based budgets. The cost of these medical examinations may be covered through the HealthChoices program.

*Comment: Subsections (f) and (g).* One commentator questioned the language of these subsections as they require the county agency to obtain color photographs and medical evidence or consultation whenever possible and appropriate. The commentator inquired whether the Department will question the county agency's determination of the appropriateness in these circumstances.

*Response:* The Department considered the comment but did not change the subsections and will provide direction through interpretive guidelines. Color photographs are necessary when children have visible injuries and medical evidence should support the agency determination in child abuse reports.

*Comment: Subsection (h).* A commentator suggested that the term "certified medical practitioner" be expanded to include registered nurses as school nurses often complete medical examinations when there is an indication of serious physical injury.

*Response:* The Department considered the comment but did not change the subsection. The Department recognizes that often school nurses have contact with children who are the subjects of abuse reports. However, they are not included in the definition of "certified medical practitioner." They may not conduct the examination to determine that an injury meets the definition of "serious physical injury" under the statute. They will document injuries for reporting purposes and are required reporters.

*§ 3490.56. County agency investigation of suspected child abuse perpetrated by persons employed or supervised by child care services and residential facilities.*

*Comment:* Numerous comments were received concerning the need for the county agency to approve the safety plan of child care and residential facilities when investigating reports of child abuse within these facilities. Commentators perceived the Department as abdicating responsibility for licensing these facilities to the county agency. Several commentators felt that they were placed in awkward positions and that conflicts of interest may arise. There were also comments that not all child care facilities obtain ChildLine and State Police clearances because it is inconvenient. One commentator reported that investigation of these reports burdens the county agency and that county agencies have no jurisdiction over these facilities.

*Response:* The Department considered the comment but did not change the section. The county agency is required to investigate reports of suspected child abuse when the alleged perpetrator is employed by a child-care facility. It is during these investigations that the county agency would need to approve the safety plan developed to assure the safety of the children within the care of the facility. The county agency is then required to submit the safety plan to the Department. The Department does not require the county agency to license the child-care facility. The Department would assume the responsibility to investigate these reports and to obtain the safety plan when the facility is an agent of the county agency as defined in § 3490.81 (relating to responsibilities of the Department and the county agency) and section 6362(b) of the CPSL (relating to responsibilities of county agency for child protective services).

*§ 3490.58. Notifications.*

*Comment: Subsection (a)(1).* Several commentators requested clarification regarding the need to provide the alleged perpetrator with the specific allegations prior to the interview because a description may compromise the

investigation. Commentators further requested the Department develop a uniform notification letter to the subjects of the report.

*Response:* The Department recognized that notification of specific allegations at the onset of the interview could compromise the investigation and revised the subsection. The initial notification may be limited to the existence of the report and type of suspected abuse. This will be confirmed in writing within 72 hours under § 3490.58(b). The Department will develop a model notification letter.

*Comment:* One commentator raised concern that reference is made to the right of the subjects to written notification of the existence of the report and a copy of the report. Clarification was requested of what information a subject may receive and requested a clear delineation of the confidentiality of the referral source.

*Response:* The Department referenced the confidentiality of the referral source throughout the chapter, specifically in §§ 3490.37, 3490.91, 3490.94 and 3490.104. It also appears in section 6340(c) of the CPSL (relating to release of information in confidential reports); therefore, there is no need for inclusion. The subjects of the report are entitled to copies of the Report of Suspected Child Abuse (CY-47), Child Protective Service Investigation Report (CY-48), and Child Protective Service Supplement Report (CY-49).

*§ 3490.59. Action by the county agency after determining the status of the report.*

*Comment: Subsection (b).* Two commentators, including IRRC, raised concern that when reports are unfounded and the agency determines that the family is in need of services, the county shall advise the family of social services available. The commentators were concerned that the county agencies may refuse to accept families for service when they have in fact determined that the family is in need of services. Clarification of the Department's intent was requested. IRRC further requested that there be a cross reference to services available through Subchapter C.

*Response:* The Department amended the section to state that if the report is unfounded and the county agency determines that there is a need for services other than those services provided by the county agency, the county agency will notify the family of other services available.

*§ 3490.60. Services available through the county agency.*

*Comment:* One commentator expressed concern that the county agency may incur increased fiscal burdens as a result of being required to provide or arrange or otherwise make available the enumerated services for the prevention and treatment of child abuse and inquired if the Department would provide the resources necessary to provide these services. The commentator inquired if the county agency would need to develop self-help groups if there are none located in the county and whether the county agency would be responsible to incur medical expenses during the course of child abuse investigations.

*Response:* The Department adopted the regulatory language directly from section 6365 of the CPSL (relating to services for prevention, investigation and treatment of child abuse) and therefore, made no changes. The county agency is responsible for services that are deemed necessary to treat and prevent child abuse. If self-help groups would be the most effective treatment for families, the county would need to assure that those services are available to the family either directly, through purchase

of service or by referral. Investigative medical expenses incurred, not covered through Medical Assistance, HealthChoices, insurance or paid by the family would become the responsibility of the county agency as required by the statute.

*Comment: Paragraph (3).* One commentator suggested the inclusion of language in the section to allow participation in State or local child death review teams.

*Response:* The Department amended the paragraph to permit participation in local or State child death review teams. Section 6365 of the CPSL requires each county agency to make available, among its service for the prevention and treatment of child abuse, a multidisciplinary team (MDT). The review of child deaths through use of MDTs is necessary to review county action and to identify similarities among cases. The local child fatality review team would be convened by the county agency to complete case specific review of circumstances relating to a child death. The purpose of the local MDT would be the investigation of a child death and the development and promotion of strategies to prevent child abuse in the family or in others.

The inclusion of the regulatory citation to sections 6343(b) and 6365 of the CPSL provides clarification of the authority to convene a State or local child fatality review to review a child death in this Commonwealth. It is a significant strategy to prevent child death. The Department contends sharing information among members of the team is necessary to fulfill its responsibility to abate child abuse and to reduce the number of child deaths in this Commonwealth.

*§ 3490.61. Supervisory review and child contacts.*

*Comment: Subsection (a).* Four commentators, including IRRC, raised concern that the “10 day supervisory review” was deleted from the section and replaced with “regular and ongoing basis.” Commentators stated the section provides an unclear standard. A commentator stated the supervisor should review the case in the beginning of the investigation because it relates to child safety. Commentators requested further clarification on whether notations made in the case record dictation would constitute the supervisory log.

*Response:* The Department acknowledged the need for clarity regarding regular and ongoing supervisory review and documentation and added requirements for reviews of these cases every 10-calendar days during the investigation period. The Department would accept notations made in the case record at 10-day intervals provided those notations address child safety and risk. This does not preclude supervisors from having a separate log.

*Comment: Subsection (b)(2)(ii).* Two commentators requested the term “oversight” be defined.

*Response:* The Department considered the comment but did not include a definition of the term “oversight.” Oversight is a routine responsibility of supervision in assuring that the agency case management responsibilities are met.

*Issue: Subsection (f).* The Department included in the subsection that the county agency, as a provision of the family service plan require the parent to notify the county agency of any change of residence within 24 hours. This clarified regulation increases parental accountability and assures the safety of children by reducing the number of persons who elude county agency involvement.

*§ 3490.62. Repeated child abuse.*

*Comment:* IRRC and one commentator raised concern that an MDT is not convened until after three substantiated reports of child abuse. Commentators recommended that the MDT be convened after two substantiated reports of abuse in an attempt to prevent future incidents of abuse and assure child safety.

*Response:* The Department accepted the recommendation and amended the section to require an MDT review after one substantiated report of abuse and the receipt of a subsequent report of suspected child abuse. After the receipt of the subsequent report of suspected child abuse, the section requires a review of the family service plan by the administrator or a designee, the supervisor and the caseworker. The county agency shall provide a recommendation to the MDT related to the appropriateness of the plan and the need for additional services to protect the child.

*3490.65. Staffing and staff qualifications.*

*Comment:* IRRC commented this section requires a county agency to have sufficient qualified staff and to be organized to perform the functions required by the statute. The section does not provide guidance on how this is to be accomplished or how it will be evaluated and recommended addition of a reference to § 3130.32 (relating to staffing requirements).

*Response:* The Department deleted this section and amended § 3490.341 (relating to staff-to-family ratios) which requires county agencies to have qualified staff to perform the functions required by the statute which includes a reference to § 3130.32 (relating to staffing requirements).

*§ 3490.67. Written reports to ChildLine.*

*Comment: Subsection C.* Three commentators raised concern related to the addition of “pending criminal court jurisdiction” as an interim disposition on reports of alleged child abuse. They advised that this would seem to hamper the criminal proceeding in that the district attorney’s office would not be able to use the indicated disposition in the criminal proceeding and that defense attorneys would be able to use the lack of a disposition to their advantage. Commentators also believed that the potential for appeals within the criminal proceeding could lengthen the time frame for the county’s determination and would prohibit the county from developing a permanency plan as required by Adoption and Safe Facilities Act of 1997 (42 U.S.C.A. §§ 678, 673b and 678b).

*Response:* The Department did not intend for the county agency to delay the status determination of a report if there was sufficient evidence for disposition. The Department amended the regulation for clarification. In cases when the county agency would be approaching the 60-day time limit and is unable to make a determination, the pending criminal court status could be utilized. The section does not preclude the county from making a determination if substantial evidence exists.

*§ 3490.70. Expunction, sealing and amendment of report by the county agency.*

*Comment:* One commentator raised concern that the county agency shall notify persons to whom they provided child abuse information of the need to expunge this information when the county agency is notified by ChildLine. The process of retrieving this information and providing the notification is potentially time consuming and a clarification was requested on whether the notification should be verbal or written.

*Response:* The county agency has discretion on the manner the notification is provided to persons required to receive notice. A county agency should develop an internal policy to efficiently implement a notice system.

*Comment:* Two commentators, including IRRC, advised that section 6341 of the CPSL (relating to amendment or expunction of information) eliminates the sealing of reports and recommended the deletion of the reference.

*Response:* The Department reviewed the comment and has deleted the reference to sealing of reports throughout the section. The CPSL no longer grants the Secretary the statutory authority to seal reports of child abuse or to access sealed records.

§ 3490.71. *Guardian ad litem or court designated advocate.*

*Comment:* One commentator inquired if the Department should determine a maximum age for which the guardian ad litem would determine the child's wishes.

*Response:* The Department considered the comment but did not change the section. There are numerous developmental variables included in the decision making process of representation of the child's wishes to the court which should not be unilaterally based on age.

*Comment:* Five commentators, including IRRC, recommended amending regulatory language that would allow cooperation of the county agency with both a guardian ad litem and a court designated advocate. As proposed, the section appeared to limit cooperation to one or the other. Commentators recommended the word "or" be changed to "and."

*Response:* The Department reviewed the comments and made the necessary change to provide release of information to both the guardian ad litem and the court designated advocate.

#### *Confidentiality*

§ 3490.91. *Persons to whom child abuse information shall be made available.*

*Comment: Subsection (a)(1).* One commentator advised that a guardian ad litem may release information obtained in the course of representing a child with persons who are not enumerated in regulation but are in need of the information. The language relating to civil and criminal penalties for releasing the information should not apply to a guardian ad litem.

*Response:* The Department reviewed the comment but did not change the section. The statute does not provide immunity from civil or criminal liability to guardians ad litem who release information to persons not permitted to receive the information.

*Comment: Subsection (a)(1).* Two commentators expressed concern relating to the release of the name of the reporter. One commentator requested the term "legitimate" be defined. The remaining commentator advised that the release of the reporter's name places the agency in a precarious position in determining whether other agencies can assure the confidentiality of the reporter.

*Response:* The Department added language to provide clarity. "Legitimate" was not defined but language was added that links the release of the reporter's name to child protection.

*Comment: Subsection (a)(3).* Five commentators recommended the term "or" be changed to "and" which would allow the release of child abuse information to both the guardian ad litem and the court designated advocate. One

commentator further recommended that the Department include a definition of "court designated advocate."

*Response:* The Department made the necessary regulatory change to allow for release of information to both the guardian ad litem and a court designated advocate. The Department added a definition of "court designated advocate" to § 3490.4.

*Comment: Subsection (a)(5).* Two commentators stated that a written court request for child abuse information is not required by statute and is cumbersome. One of the commentators requested clarification of the reason the court must contact the Department.

*Response:* The Department included the provision requiring the written court request of child abuse records to authenticate the request. Requests made by telephone would be difficult to verify; however, the Department will accept requests from the court by means of facsimile. The regulation includes the specific documents available from the Department. ChildLine will forward written court requests for additional information not on file with ChildLine to the county agency administrator for compliance. Written court requests to the Department would include Statewide child abuse reports while information at the county agency level may not include child abuse reports from other county agencies.

*Comment:* One commentator recommended the inclusion of district justices in the enumeration of persons who may have access to child abuse information because this has been introduced in House Bill 1992.

*Response:* The Department considered the comment but did not change the subsection. The Department cannot include the release of information to district justices because the statute does not currently allow for a release. The Department will immediately implement any statutory changes and provide notice of amendment to county agencies.

*Comment: Subsection (a)(5)(ii).* One commentator suggested the regulation appears to unduly restrict custody courts to acquire all information maintained on a child or family by the county agency. The commentator also recommended the deletion of the second sentence of subparagraph (ii) which provided for release of only the investigatory information.

*Response:* The Department deleted the second sentence of subparagraph (ii), thus allowing the court to receive all information from the county agency. This information is needed to ensure that all related information is available when making custody decisions for children to assure that the safety of the child is maintained.

*Issue: Subsection (a)(10).* The Department has added the word "immediately" to provide consistency with section 6340 of the CPSL which requires the immediate referral of reports of child abuse to law enforcement officials.

*Comment:* One commentator recommended the addition of language which would allow members of a local or State child death review team access to confidential child abuse information.

*Response:* The paragraph was amended to include the CPSL citations that grant the Secretary the explicit, discretionary authority to complete a performance audit of any CPSL activity. Section 6343(b) of the CPSL provides: "Notwithstanding any other provision of this chapter, the Secretary or a designee of the secretary may direct, at their discretion, and after reasonable notice to the county agency, a performance audit of any activity

engaged pursuant to this chapter." The Secretary's discretionary authority to convene a child fatality review is outside the scope of section 6340 of the CPSL. The Secretary used her authority to conduct child fatality reviews to determine regulatory compliance and to abate future child abuse.

The inclusion of the regulatory citation to sections 6343(b) and 6365 of the CPSL provides clarification of the authority to convene a State and local child fatality review to review a child death in this Commonwealth. It is a significant strategy to prevent child death. The Department contends sharing information among members of the team is necessary for the Department to fulfill its responsibility to abate child abuse and to reduce the number of child deaths in this Commonwealth.

*§ 3490.92. Requests by and referrals to law enforcement officials.*

*Comment: Subsection (b)(7).* Two commentators expressed concern with the requirement to complete the written referral to law enforcement officials on the next work day following the verbal report.

*Response:* The Department considered the comment but did not change the subsection. The written referral to law enforcement officials within this time frame is necessary so that they have the information in a timely manner to insure a thorough and efficient review.

*Comment: Subsection (c).* Two commentators advised that the subsection provides for inconsistent referrals to law enforcement.

*Response:* The Department considered the comment but did not change the subsection. Section 6340 of the CPSL authorizes the immediate referral to law enforcement officials of cases involving homicide, serious bodily injury, sexual abuse or cases perpetrated by nonfamily members which are investigated by county agencies. The Department cannot include referral of reports not enumerated in the statute. It should be noted that when the alleged perpetrator is not a person responsible for a child's welfare, the county agency is required to immediately report the allegations to law enforcement officials.

*Comment:* One commentator recommended the Department devise a form for reporting referrals which do not meet the criteria for investigation by the county agency to law enforcement.

*Response:* The Department considered the comment but did not change the regulation. A form for reporting other allegations concerning child abuse to law enforcement agencies should be developed at the county level to meet the local law enforcement needs.

*General Requirements for Child Protective Services*

*§ 3490.104. Release of information to a subject of a report.*

*Comment:* Two commentators, including IRRC, advised that the provision of information to the District Attorney for dissemination to criminal defendants violates due process and section 6340(b) of the CPSL which allows for release of child abuse information to subjects of the report upon written request.

*Response:* The Department amended the section to provide for the release of child abuse information in the county agency's possession to the criminal defendant and the District Attorney.

*§ 3490.105. Request by the subject of a founded or indicated report for expunction, amendment or sealing of an abuse report received by ChildLine prior to July 1, 1995.*

*Comment:* IRRC and another commentator suggested the deletion of references to sealing of reports because section 6341 of the CPSL rescinds the authority to seal reports.

*Response:* The Department reviewed the comment and deleted references of the Secretary's authority to seal reports. The CPSL no longer grants the Secretary the authority to seal reports of child abuse or to access sealed records.

*Comment:* Two commentators, including IRRC, inquired about the inclusion of the distinction of reports received prior to July 1, 1995.

*Response:* The Department differentiated between reports received prior to July 1, 1995, and those received after that date. Persons who were entitled to request the amendment or expunction a founded report received prior to July 1, 1995, maintain this right.

*§ 3490.105b. Request by a nonperpetrator subject to amend an indicated report of child abuse received after June 30, 1996.*

*Comment:* Seven commentators expressed concern that nonperpetrator subjects are given the right to appeal unfounded reports. One commentator further stated that giving nonperpetrators appeal rights is an excessive and unreasonable right not afforded in criminal proceedings.

*Response:* The Department deleted the section to be consistent with section 6341(a) of the CPSL.

*Comment:* IRRC advised the section does not include a provision for notifying the county agency if a request for amending a report is granted.

*Response:* The Department deleted the section to be consistent with section 6341(a) of the CPSL.

*§ 3490.106a. Hearings and appeals proceedings for indicated reports received by ChildLine after June 30, 1995.*

*Comment: Subsection (g).* IRRC and two commentators expressed concern that the statute places the burden of proof in these appeals on the county agency while the subsection places the burden of proof on the perpetrator.

*Response:* The Department amended the subsection to place the burden of proof on the county agency. The Department deleted reference to the perpetrator bearing the burden of proof in appeals.

*Verification of the Existence of Child Abuse and Student Abuse Records for Child Care Services*

*§ 3490.124. Departmental procedures for replying to a request for verification.*

*Comment:* One commentator supported the exemption of workfare participants from the payment of the fee for verifications.

*Response:* The Department did not amend the section based on support for this provision.

*Verification of the Existence of Child Abuse and Student Abuse Records for School Employees*

*§ 3490.131. Definitions.*

*Comment:* IRRC and two commentators requested clarification regarding the definition of "administrator." IRRC advised the definition deviated from the statutory definition. Another commentator noted that the definition was limited in that governing bodies are responsible for hiring decisions, but normally delegate these responsibilities to other personnel.

*Response:* The Department adopted the statutory definition of "administrator."

*Comment:* IRRC recommended use of the statutory definition of "applicant." The regulatory definition refers to a person who applies for employment as opposed to the statutory definition that refers to a person who applies for a position.

*Response:* The Department amended the section to define an applicant as a person who applies for a position. However, the Department included a volunteer at a charter or regional charter school in the definition of "applicant" to be consistent with the act of June 19, 1997 (P. L. 225, No. 22).

*Comment:* IRRC and two commentators requested clarification regarding the term "direct contact" with students. Further clarification was requested for the phrase "unsupervised access" within this definition.

*Response:* The Department considered the comment but did not change the regulation. A person who has contact with a student who is not supervised directly by a person with a clearance needs to be screened. This contact does not need to be scheduled contact and would apply to a person who has unsupervised contact with a child while in the school setting. This would include independent contractors the school would procure for all purposes. The intent of the requirement is focused on child protection.

*Comment:* Three commentators, including IRRC, raised concern related to the term "position." One commentator believed that the definition was too narrow and that persons who are administratively reassigned would need to receive a clearance statement. Although the chapter addresses this in § 3490.132, the commentator does not believe this foreclosed potential problems. Another commentator also believed the definition was too narrow but that the provisions of the statute addressed situations where employees move from one school or assignment to another which includes persons who transfer from one building to another. IRRC requested an explanation of the categories of employment which would be considered positions.

*Response:* The Department considered the comment but did not change the section. Persons who change job classifications would be required to be screened. The Department does not believe that the statute contemplates that persons be screened when they transfer from one school building to another, within the same school district, and have not changed job classification.

*Comment:* IRRC and two commentators recommended the inclusion of charter schools in the definition of "public school."

*Response:* The Department amended the definition to include charter schools in the definition of "public school."

*Comment:* IRRC requested clarification on the distinction between "employment" and "position" in the definition of the term "transfer."

*Response:* The Department through the definitions of "applicant" and "transfer" require an applicant who changes job classification to obtain a new verification of child abuse clearance statement. The term "position" is used consistently throughout the CPSL and this chapter.

§ 3490.132. *Responsibilities of an administrator.*

*Issue: Subsections (b) and (c).* The Department amended the subsections to include language that is consistent with section 6355 (a)(2)(i) and (ii) of the CPSL (relating to requirement).

*Comment: Subsection (g).* One commentator stated that the subsection seems inconsistent with the interpretation of "position" and requires a substitute teacher provide a recent clearance check for each school when application is made for inclusion on the school substitute list.

*Response:* The Department considered the comment but did not change the subsection. A person employed by more than one school district shall provide a verification of child abuse clearance statement to each school district.

§ 3490.133. *Responsibilities of an applicant.*

*Comment: Subsection (a).* IRRC stated that the proposed subsection requires the fee for the clearance statement may not exceed \$10 and questions how an applicant will know what amount should be provided in the check or money order. The recommendation was made to add language which advises that applicant to submit the amount specified on the form. IRRC noted the information on where to obtain and submit the form is located in § 3490.137 and suggested this information be incorporated into this section.

*Response:* The Department amended the subsection for clarity. The subsection provides that payment by a check or money order in the amount specified on the application be submitted to the Department. The Department incorporated § 3490.137 within this section which informs applicants where to obtain and submit the clearance forms. As a result of this change, the Department deleted § 3490.137.

§ 3490.134. *Information relating to prospective school employees.*

*Comment: Subsection (a).* IRRC raised concern that the requirements are similar to the CPSL. However, the CPSL provides for exemption if one of the criteria are met.

*Response:* After discussion with IRRC, the objection to the Department's interpretation of the statute was withdrawn.

*Comment: Subsection (b).* IRRC advised that the proposed subsection includes allowing applicants to submit the request for clearance check within 24 hours of provisional employment. The statute requires that the employee demonstrates application prior to employment.

*Response:* The Department deleted the provision for application within 24 hours.

#### *Subchapter B. Abuse of Students in School*

##### *Introduction*

§ 3490.143. *Definitions.*

*Comment:* IRRC and one commentator suggested clarification be provided relating to the term "administrator." IRRC advised the definition deviates from the statute while the remaining commentator suggested that in some schools, the principal may not be the person designated to report incidents of student abuse.

*Response:* The Department adopted the statutory definition of "administrator."

*Comment:* IRRC advised the definition of "school" differs from the statutory definition in that intermediate unit or area vocational technical school was deleted from the regulatory definition.

*Response:* The Department adopted the definition of "school" used in § 3490.131.

*School Responsibilities*

§ 3490.151. *Required reporting.*

*Comment:* One commentator noted that school employes are required to report suspected student abuse on the basis of professional or other training and experience. The commentator identified the importance of being able to properly make this determination. The commentator believes the Department should provide adequate training and cooperate with school entities to aid personnel in recognizing the signs of child abuse.

*Response:* The Department considered the comment but did not change the section. The Department recognizes the need for training and will assist in the development of training material. The Department will work cooperatively with the Department of Education in training school personnel. County agencies also assist local school districts with this training.

§ 3490.152. *Responsibilities of administrators and school employes.*

*Comment: Subsection (a).* Two commentators, including IRRRC, expressed concern with the language which requires school employes in certain cases to report suspected student abuse directly to law enforcement officials and the district attorney. Clarification was requested defining what "certain cases" school employes would be required to report, other than when the administrator is the alleged perpetrator of the student abuse.

*Response:* The Department clarified the regulatory language requiring school employes to report suspected student abuse to law enforcement and the district attorney when the administrator is the alleged perpetrator.

*Comment: Subsection (c).* IRRRC suggested the information on obtaining the form for reporting suspected student abuse be included in the section.

*Response:* The Department amended the section to provide direction on where to obtain the forms for reporting suspected student abuse.

§ 3490.154. *Release of information by a school employe including an administrator.*

*Comment: Subsection (a).* IRRRC advised the information in reports of suspected student abuse is confidential and the statute enumerates who may receive this information. IRRRC pointed out the regulation appears to include persons who are not authorized to obtain this information and those persons should be deleted. One commentator requested that guardian ad litem and court designated advocates be included as persons to whom this information may be provided.

*Response:* The Department amended the subsection to comply with the statutory authority of section 6352(a) of the CPSL (relating to school employes).

*County Responsibility*

§ 3490.171. *Receipt and investigation of reports of suspected student abuse.*

*Comment: Subsection (b).* IRRRC recommended that the subsection include the information contained in the county agency's oral report to ChildLine.

*Response:* The Department added clarifying language which includes the required information when making oral reports of student abuse.

*Comment: Subsection (d).* IRRRC raised concern related to reports that are not received by the Department within 60-calendar days from the date of oral report which are

considered unfounded. It was recommended that the Department verify the report was unfounded to ensure the paperwork was not lost.

*Response:* The Department included clarifying language requiring ChildLine to contact the county agency to verify the report was not completed within 60-calendar days prior to expunction of the report.

*Comment: Subsection (f).* IRRRC recommended changing the citation which references the submission of a new report when a final status determination is made. There is no reference to the Child Protective Services Investigation Report Form in subsection (a).

*Response:* The Department corrected the citation referencing subsection (e).

§ 3490.173. *Notifications by the county agency.*

*Comment:* IRRRC advised the section provides for written notification to the subjects of the report within 72 hours of the oral notification of the rights regarding amendment and expunction. Section 6353.2(d) of the CPSL (relating to responsibilities of county agency) permits delaying the notice if the notification is likely to threaten the safety of the student or the county agency worker, to cause the school employe to abscond or to significantly interfere with the conduct of a criminal investigation while the section does not.

*Response:* The Department amended the section to include language which allows for delaying the notification under section 6353.2(d) of the CPSL.

*General Requirements for Student Abuse*

§ 3490.192. *Request for a hearing from a school employe for indicated reports of student abuse.*

*Issue:* As a result of several comments received on related student abuse issues, the Department amended the regulation to provide consistency with the statutory requirement placing the burden of proof on the county agency in requests for hearings relating to appeals of the Secretary's decision to deny amendment and expunction of student abuse cases. A similar concern was raised regarding appeals relating to child abuse reports in § 3490.106.

*Subchapter C. General Protective Services*

*County Responsibilities*

§ 3490.231. *Functions of the county agency for general protective services.*

*Comment:* IRRRC inquired if the objectives have been outlined elsewhere and if the county agencies have the power and resources to fulfill the objectives.

*Response:* The Department used the objectives from section 6373 of the CPSL (relating to general protective services responsibilities of county agency). The issue of resources will be addressed through the needs-based budgeting process. Training is available to county agencies to aid county agency staff in achieving the objectives. The Department and Pennsylvania Children and Youth Administrators (PCYA) are developing practice standards which will aid county agencies in achieving the objectives. The Department expects to distribute these standards to county agencies to begin implementation by the year 2000.

*Comment: Paragraph (2).* Three commentators requested the inclusion of the phrase "whenever possible" related to preventing abuse, neglect and exploitation of children.

*Response:* The Department considered the comment but did not make the change. The Department adopted the objectives in section 6373 of the CPSL.

*Comment: Paragraph (3).* Three commentators recommended the inclusion of the phrase "assist in overcoming" related to problems that could result in dependency.

*Response:* The Department considered the comment but did not make the change. The Department adopted the objectives in section 6373 of the CPSL.

*Comment: Paragraph (4).* One commentator recommended expanding the language to include kinship care as a substitute care placement.

*Response:* The Department included clarifying language to include placement with an individual who has a significant relationship with a child or the child's family and that the home shall be approved by the county for this purpose which supports placement in the least restrictive setting and kinship care.

§ 3490.232. *Receiving reports and assessing the need for services.*

*Comment: Subsection (a).* One commentator advised that the regulation appears to limit the authority of the juvenile court to receive and any person to file a petition for adjudication of dependency under section 6334 of the Juvenile Act (relating to petition).

*Response:* The Department amended the regulation and cited the Juvenile Act provision that allows any person to file a petition alleging dependency.

*Comment: Subsection (d).* One commentator expressed concern that no time frame for completing the initial assessment was included in the regulation and questioned whether this will become a licensing issue.

*Response:* The Department considered the comment but did not make the change. Response time for initial assessment should be directly related to risk. At the time a referral is accepted for service, the risk assessment screening process requires that a level of risk is assigned to the case. Consistent with the identified risk and the allegations of the report, the county agency would decide when to see the child. Some county agencies have devised a level system where the supervisor assigns the required time within which the child must be seen. The required response time is based upon child risk.

*Comment: Subsection (e)(3).* One commentator suggested the addition of language calling for services that respond to risk, rather than simply aid in determining the need for services.

*Response:* The Department included clarifying language in subsection (d)(4) to coordinate risk with the creation of a family service plan. The plan required under §§ 3130.61 and 3490.235 (relating to family service plans; and services available through the county agency for neglected children) is properly cross referenced to identify needed services. The level of services provided should be consistent with the level of risk and should address child safety.

*Issue: Subsection (e)(4).* The Department included language which requires the use of the risk assessment process in the development of the family service plan. This is related to the previous comment which suggests the level of service should respond to the level of risk to the child.

*Comment: Subsection (f).* Four commentators suggested that the completion of an assessment for reports of

general protective services should be extended to 90 days. The commentators believed that the proposed time limit of 60 days is unrealistic.

*Response:* The Department considered the comment but did not make the change. Assessments need to be completed in a timely manner. Section 6375(c)(1) of the CPSL (relating to county agency requirements for general protective services) mandated the completion of an assessment within 60 days.

*Comment: Subsection (g).* Five commentators raised concern that the subsection required a home visit during the assessment period and believed this should be left to the discretion of the county agency.

*Response:* The Department considered the comment but did not make the change. A visit must be made to the child's residence during the assessment period. While presenting allegations may not indicate that a home visit is necessary, often there are undisclosed issues not provided to the county agency at referral. The Department decided that home visits are necessary as part of the risk assessment process which requires a risk rating based on the condition of the home. The risk assessment process is not complete without a visit to the home. Home visits are required by section 6375(g) of the CPSL. The county agency maintains the ability to discontinue an assessment, when after one contact the allegations are determined to be inaccurate.

*Comment: Subsection (i).* One commentator reported that previous language required that the county agency would make unannounced home visits if an announced home visit would result in an inaccurate portrayal of the home conditions. The regulation as written does not allow county discretion.

*Response:* The Department considered the comment but did not make the change. Unannounced home visits, in some instances, are necessary to obtain an accurate depiction of the conditions in the child's home. The subsection does not require unannounced home visits. It allows county agencies to make unannounced home visits.

§ 3490.233. *Protective custody.*

*Comment:* One commentator requested clarification related to taking a child into protective custody when parents fail to act based on religious beliefs.

*Response:* The Department made no change to the section as this was a request for clarification. Persons authorized to take protective custody of a child under section 6324 of the Juvenile Act (relating to taking a child into custody) and sections 6315, 6339(b) and 6375(i)(j) of the CPSL may take protective custody of a child if the parents fail to provide essential medical treatment to protect the child.

§ 3490.234. *Notifications.*

*Comment: Subsection (a).* One commentator raised concern regarding the omission of the requirement for written notification to the parent which advises that the agency has received a report and will complete an assessment. The only notification that is required is the verbal notification at the time of the initial interview.

*Response:* The Department considered the comment but did not make the change. Written notification is not a requirement of the CPSL at the time of oral report. The Department maintained the requirement of verbal notification at the time of the oral report and written notification when the county agency accepts the family for service.



*Comment: Subsection (b) and subsection (b)(1).* Three commentators, including IRRC, recommended the word "Department" be changed to "county agency" because it is at the county level that the family is accepted for service.

*Response:* The Department amended the section and changed the word "Department" to "county agency."

§ 3490.235. *Services available through the county agency for neglected children.*

*Comment:* IRRC recommended the proposed heading of the section be changed because services should not only be provided to children who are neglected.

*Response:* The Department amended the section heading to read "services available through the county agency for children in need of general protective services."

*Comment: Subsection (e).* Two commentators requested clarification related to the phrase "regular and ongoing" and requested guidelines for supervisory review.

*Response:* The Department clarified the regulation to include supervisory review of the referral every 10-calendar days during the assessment period. The Department will accept a supervisor's documentation of review in the case record or by another method. The review should include a statement of the review and that the supervisor concurs with the caseworker's assessment that the child is safe and the services being provided to assure the continued safety of the child are appropriate.

*Comment: Subsection (h).* One commentator raised concern that there is no corresponding provision in the child protective services section that requires a risk assessment be completed on a periodic basis.

*Response:* The Department amended § 3490.61(d) to require periodic risk assessments on substantiated cases of child abuse. The Department provides the requirements for the risk assessment process in § 3490.322 (relating to county agency compliance with risk assessment standards).

*Issue: Subsection (k).* The Department included in the subsection that the county agency, as a provision of the family service plan, requires the parent to notify the county agency of any change of residence within 24 hours. The clarified subsection increases parental accountability.

§ 3490.236. *General protective services records.*

*Issue: Subsection (a)(5).* The Department included the need for the provision of services that are consistent with the risk to the child to assure that the child is safe and receiving services that are consistent with need as identified through the risk assessment process. This amendment was made in conjunction with comments made relating to § 3490.232.

*General Requirements for General Protective Services*

§ 3490.241. *Appeals with respect to general protective services.*

*Comment:* Two commentators raised concern related to the appeals process, identifying that the family may not engage in service during the appeals process which would provide for a lengthy process. One commentator did not see the need for the appeals process when court jurisdiction may be utilized.

*Response:* The Department considered the comment but did not make the change. The county agency is responsible for assessing the need to seek court involvement in cases when parents appeal the county agency decision to accept the family for services. In cases when the family is in need of service and the safety of the child is of concern,

the agency must file a petition with the juvenile court consistent with the risk to the child. Section 6376 of the CPSL (relating to appeals with respect to general protective services) affords parents the right to appeal the county agency decision to accept the family for services.

*Subchapter D. General Requirements for Child Protective Services and General Protective Services  
Staff Orientation, Training and Certification  
Requirements*

§ 3490.311. *Establishment of a staff development process.*

*Comment: Subsection (d).* One commentator raised concern that the county agency may need to provide statistical information related to evaluating program effectiveness against measurable outcomes.

*Response:* The Department considered the comment but did not make the change. The county agency may need to provide additional information to insure that the training program is adequately meeting the program objectives. The Department is focused on staff development through the training and certification program to aid staff in meeting the demands of the child welfare system.

§ 3490.312. *Training program requirements for direct service workers.*

*Comment:* One commentator interpreted the proposed section to require that workers not provide protective services until they are certified.

*Response:* The Department considered the comment but did not make the change. The Department does not prohibit workers from providing services while they are attending CORE training. Subsection (d)(5) provides that workers who are in the process of obtaining certification may be assigned a caseload consistent with their ability to perform the job duties determined by the agency through policy and procedure. Workers who fail to achieve certification within 18 months or fail to maintain certification may not provide direct services until certification is completed.

*Comment: Subparagraph (ii)(A).* One commentator expressed concern related to the time that will be required to complete the assessment to determine recommendation of a direct service worker for certification.

*Response:* The Department considered the comment but did not make the change. The process of determining the recommendation for certification of a direct service worker is an ongoing process that is both formal and informal. During supervisory review, oversight of cases and the casework process, the supervisor would be assessing the decision making process and the worker's analytical ability.

*Comment: Paragraph (8)(i).* For a direct service worker who completed direct service worker certification during the agency training year, the county agency would be able to prorate the number of training hours the worker would need to take during the training year. One commentator reported that to prorate training in a large agency would be difficult.

*Response:* The Department considered the comment but did not make the change. To prorate training when workers have completed CORE within the calendar year, but have not reached the 20-hour annual requirement, is reasonable.

*Comment: Subparagraph (10).* Two commentators requested clarification related to workers who do not complete or maintain certification as direct service workers. A commentator inquired if failure to maintain certification

would serve as grounds for involuntary termination of employment while the other questioned what would happen to those workers who do not complete certification within 18 months.

*Response:* The Department considered the comment but did not make the change. The county agency would determine if grounds exist for termination of employment based on performance of the employe and county policy or labor contracts. The subparagraph provides that workers who do not achieve or maintain certification may not perform direct service duties until they are certified. The county agency would determine what position the worker may hold and would follow county policy and procedures.

*§ 3490.313. Direct service worker certification requirements for supervisors who supervise direct service workers.*

*Comment:* One commentator raised concern that there is no remedy for supervisors who fail to meet the requirements of this section.

*Response:* The Department considered the comment but did not change the regulation. Supervisors who fail to meet the direct service worker certification may not supervise direct service workers. At the time the supervisor achieves certification they could resume their supervisory responsibilities.

#### *Risk Assessment*

*§ 3490.321. Establishment of standards for a risk assessment process.*

*Comment:* One commentator suggested that risk assessment apply to children who are alleged to be dependent.

*Response:* The Department amended the general protective services regulation in Subchapter C to include completion of a risk assessment on all reports for children alleged to be in need of general protective services. The requirements of this section are applicable.

*Comment:* One commentator suggested that this section should include language which specifies the assessment of risk is exclusively a county determination which may not solely be based on the State-approved risk assessment process.

*Response:* The Department established a regulation to provide the framework for the risk assessment process. The determination of risk is based on this process, while casework skills are used to determine the level of risk. County agencies should utilize information obtained in the case through the assessment in ongoing phases to document risk according to the risk assessment case interval policy. Section 6362(e) of the CPSL requires county agencies to implement a State-approved risk assessment process.

*Comment: Subsection (d).* IRRRC and one commentator raised concern related to the issuance of bulletins to establish standards and questioned whether developing risk assessment is an ongoing process. The public and the Legislature have a right to know the changes to be made and have a right to participate in the regulatory review process.

*Response:* The Department deleted the reference to issuance of bulletins. The Department amended the subsection to clarify the risk assessment process. The subsection includes the current practice which is followed by county agencies.

The Risk Assessment Task Force (RATF) has been in existence since 1988 and will continue to evaluate the risk assessment process to assure child safety and the

provision of services to children and their families. Recommendations will be made to improve the process to assure that the core factors assessed continue to address child safety and family dynamics.

The standards that guide the risk assessment are included in the subsection. The CORE factors which must be assessed and the intervals at which the assessments will be completed are enumerated.

*§ 3490.322. County agency compliance with risk assessment standards.*

*Comment: Subsection (d).* One commentator recommended a statement which provides risk assessment as an ongoing process completed when making case decisions.

*Response:* The Department considered the comment but did not make the change. Risk assessment training is a component of the CORE training prior to certification of a direct service worker. The training includes intervals and circumstances during the case when the risk assessment form should be completed.

#### *Annual Report*

*§ 3490.331. Annual report on required activities.*

*Comment:* One commentator recommended the inclusion of statistics related to unfounded cases which go beyond the 60-calendar day time limit and are determined unfounded as well as those cases that are unfounded resulting from a lack of evidentiary proof as required by the Supreme Court in *A.Y. v. Department of Public Welfare*, 641 A.2d 1148 (1994). One commentator also suggested including recommendations for improving the child welfare system to children and families.

*Response:* The Department considered the comment but did not make the change. The annual report does include a table which provides the number of reports that were expunged because a county agency could not complete an investigation within the 60-calendar day limit in section 6368(c) of the CPSL. There are no statistics relating to expunction of reports resulting from a lack of evidentiary proof required by the Supreme Court in *A.Y. v. Department of Public Welfare*, 641 A.2d 1148 (1994).

*Comment:* IRRRC reported that one commentator reported that costs were not factored into need-based budgets and therefore the fiscal impact to the public sector was underestimated and the published appropriations will not reflect actual costs. They recommended an explanation of the calculation of costs of the program in the report and how the calculations represent accurate costs.

*Response:* The Department considered the comment but did not make the change. The Department will include an explanation of the calculation of program costs in the annual report.

#### *Staff Ratios*

*§ 3490.341. Staff-to-family ratios.*

*Comment:* IRRRC questioned if the Department has established staff-to-family ratios. Two commentators expressed concern relating to the 1 to 30 staff-to-family ratio set forth in § 3130.32 which is believed to be too high. One commentator suggested the Department consider a staff-to-children ratio as there is more than one child in most families.

*Response:* The Department provided a cross reference to §§ 3130.32 and 3140.17 (relating to plan and budget estimates) which establishes the staff-to-family ratio. The

Department will participate in the reduction of caseload size by incremental decreases through the needs-based budget process.

*Standards for Staff*

§ 3490.362. *Licensure requirements for persons providing services arranged or provided by the county agency.*

*Comment:* One commentator raised concern that persons who provide service which is arranged or provided by the county agency must possess a license issued by the Department of State if the profession is subject to mandatory licensure. The commentator noted potential difficulty in assuring that services are provided in rural areas.

*Response:* The Department considered the comment but did not make the change. If a profession is subject to mandatory licensure, services from a qualified professional are required.

*Attorney for the County Agency*

§ 3490.371. *Availability of an attorney for the county agency.*

*Comment:* One commentator inquired whether consideration was given to development of training requirements for county solicitors on issues of child abuse and neglect and child welfare law. The commentator further requested clarification on the steps taken.

*Response:* The Department considered the comment but did not make the change. County solicitors benefit from training. The Department, in conjunction with the PCYA, will continue to develop continuing legal education. Special training has been provided for solicitors at PCYA quarterly meetings with the approval of the Pennsylvania Bar Association.

*Fiscal Impact*

• *Public Sector*

(1) The counties received an additional \$15,166,682 between FY 1995-96 and FY 1997-98 to implement the act that went into effect in those years. The provisions that went into effect between FY 1995-96 and 1997-98 include investigating cases of imminent risk of suspected serious physical injury or sexual abuse; investigating cases of suspected serious bodily injury or sexual abuse of students allegedly perpetrated by a school employee; and implementing a risk assessment process to determine the

level of risk to a child if the child remains in the home where the alleged abuse occurred.

The allocations were:

- FY 1995-96—\$3,010,500
- FY 1996-97—\$5,545,091
- FY 1997-98—\$6,611,091

(2) The estimate for FY 1998-99 is based on a supplemental increase for January 1999 through June 1999 for implementation of these final rules, which are anticipated to be finalized in January of 1999. The estimate is calculated based on half of the total estimated increase for FY 1999-00 less the 3.5% cost of living increase.

(3) The estimate for FY 1999-00 is based on increased county and State costs associated with implementing the additional requirements in this final rulemaking to:

- Provide general protective services.
- See children weekly when they remain in their own homes and are at high risk of further abuse.
- Visit the homes of children at least once during the investigation or assessment period.
- Investigate reports of suspected child abuse for persons between the age of 18 and 20 when the alleged abuse occurred before the person reached 18 years of age.
- Convene a county's multidisciplinary team when the county agency receives reports of suspected child abuse where the children are the victims named in substantiated reports of child abuse previously.

The estimated increased costs for FY 1999-00 are based on the Department's knowledge and experience with county agencies in their implementation of the requirements in this final rulemaking.

The Department's estimated increase was based on a review of funds certified for counties in their FY 1998-99 budgets for in-home services.

(4) The estimates for FY 2000-01 through 2002-03 includes an annual increase of 3.5% of the total increased allocations to county agencies for the implementation of the CPSL from FY 1995-96 through 1999-00.

Estimated increased costs to implement the provisions of this rulemaking from FY 1998-99 through 2002-03 are shown on the following chart.

Year	1998-99	1999-00	2000-01	2001-02	2002-03
Federal	\$2,340	\$4,844	\$5,013	\$5,189	\$5,370
State	\$7,607	\$15,746	\$16,297	\$16,867	\$17,457
Counties	\$1,902	\$3,936	\$4,074	\$4,217	\$4,364
Total	\$11,849	\$24,526	\$25,384	\$26,273	\$27,191

(The figures are in thousands)

Any savings were factored into the estimated budgets that counties submitted to the Department.

• *Private Sector*

These amendments require an applicant for employment in a school to pay up to \$10 to the Department to verify whether or not the applicant's name is on file in the Statewide Central Register of founded and indicated reports of child abuse and student abuse. In calendar year 1997, ChildLine received 239,466 requests for clear-

ance statements from applicants for employment when the applicants have direct contact with children. Of these 239,466, 107,478 were as a result of the amendment that requires applicants for employment in schools to receive a clearance statement from ChildLine. We estimate the number of requests will increase by 10% a year.

The following chart shows the increased costs for persons applying for employment in schools from calendar year 1998 through 2002.

	1998	1999	2000	2001	2002
Total	\$1,182	\$1,301	\$1,430	\$1,574	\$1,904

(The figures are in thousands)

• *General Public*

There will be no additional costs to the general public, except for persons applying for employment in a school who are required to pay a \$10 fee to verify whether or not the person's name is on file in the Statewide Central Register of founded and indicated reports of child and student abuse.

*Paperwork Requirements*

School administrators will be required to complete a portion of a form and send it to the district attorney and law enforcement officials when making a report of suspected student abuse. It will take approximately 15 minutes to complete this form.

Law enforcement officials will be required to complete the other portion of the form and send it to the county agency when the law enforcement official receives a report of suspected student abuse. It will take approximately 15 minutes to complete this form.

It is estimated that the costs to complete the form for reporting suspected student abuse will be nominal.

Law enforcement officials will also complete a brief form and send it to the county agency advising it of the status of a referral of suspected child abuse or student abuse that was made to law enforcement. This is a new requirement. It will take approximately 10 minutes to complete the form.

County agencies are required to assess the risk to children needing protective services and to complete a risk assessment process. It is estimated that it takes approximately 45 minutes to complete the risk assessment process.

Protective service supervisors are required to complete an Individual Training Needs Assessment (ITNA) annually for each of their staff. The ITNA is a component of the certification and training program and is used to determine the training needs of a direct service worker. It takes approximately 1 hour and 45 minutes to complete an ITNA.

A court of common pleas may request and shall receive confidential child abuse information in connection with any matter involving custody of a child. To assure that the request is from a judge, the Department is requiring that the request be in writing and either mailed or sent by facsimile to the Department or county agency. The length of time to prepare this letter is minimal.

As a result of the revision to the definition of "general protective services" in this final rulemaking, counties will be required to notify the parents that the county agency is conducting an assessment to determine the need for general protective services. Counties will also be required to send a notice to parents advising them of the results of the assessment and their right to appeal the agency's decision that the child is in need of general protective services. While counties will incur increased costs in implementing these requirements, the Department does not expect these increased costs to be substantial in relation to the overall funding for the children and youth programs.

*Effective Dates*

These amendments will take effect upon publication in the *Pennsylvania Bulletin* as final rulemaking.

*Sunset Date*

No sunset date has been established for these regulations. The Secretary of the Department is required by the law and these regulations to submit an annual report to the Governor and the General Assembly on the implementation of the law. The report must include recommendations to amend the law; thus, the Department is continuously evaluating the effectiveness of the law and the need for amendments.

*Regulatory Review*

Under section 5(a) of the Regulatory Review Act (71 P. S. § 745.5(a)), the Department submitted a copy of the notice of proposed rulemaking, published at 28 Pa.B. 1079, to IRRC and to the Chairpersons of the House Aging and Youth Committee and the Senate Committee on Public Health and Welfare for review and comment. In compliance with sections 5.1(a) and (b) of the Regulatory Review Act (71 P. S. § 745.5a(a) and (b)), the Department also provided IRRC and the Committees with copies of all comments received, as well as other documentation.

In preparing these final-form regulations, the Department has considered the comments received from IRRC, the Committees and the public.

These final-form regulations were deemed approved by the House Aging and Youth Committee and the Senate Public Health and Welfare Committee on May 4, 1999, and were approved by IRRC on May 6, 1999, in accordance with sections 5.1(d) and (e) of the Regulatory Review Act.

*Contact Person*

The contact person for these final-form regulations is Joseph L. Spear, P. O. Box 2675, Harrisburg, PA 17105-2675, (717) 787-3986.

*Findings*

The Department finds that:

(1) Public notice of intention to adopt the administrative regulations adopted by this order has been given under sections 201 and 202 of the act of July 31, 1968 (P. L. 769, No. 240) (45 P. S. §§ 1201 and 1202) and the regulations thereunder, 1 Pa. Code §§ 7.1 and 7.2.

(2) The adoption of these amendments in the manner provided in this order is necessary and appropriate for the administration and enforcement of the Public Welfare Code.

*Order*

The Department, acting under the Public Welfare Code, orders that:

(a) The regulations of the Department, 55 Pa. Code Chapters 3480 and 3490, are amended:

(1) by amending §§ 3490.1—3490.4, 3490.11—3490.21, 3490.31—3490.40, 3490.41, 3490.42, 3490.52—3490.62, 3490.67—3490.71, 3490.73, 3490.81, 3490.91—3490.95, 3490.101—3490.105, 3490.106, 3490.107 and 3490.121—3490.127;

(2) by adding §§ 3490.5, 3490.40a, 3490.105a, 3490.106a, 3490.108, 3490.109, 3490.131—3490.136, 3490.141—3490.143, 3490.151—3490.154, 3490.161, 3490.171—3490.175, 3490.181, 3490.182, 3490.191—3490.193, 3490.221—3490.223, 3490.231—3490.236, 3490.241, 3490.242, 3490.301—3490.303, 3490.311—3490.314, 3490.321, 3490.322, 3490.331, 3490.341, 3490.351, 3490.361, 3490.362, 3490.371, 3490.381, 3490.391 and 3490.401; and

(3) by deleting §§ 3480.1—3480.4, 3480.11—3480.17, 3490.43, 3490.51, 3490.63—3490.66, 3490.72 and 3490.201—3490.210; to read as set forth in Annex A.

(b) The Secretary of the Department shall submit this order and Annex A to the Office of Attorney General and the Office of General Counsel for approval as to legality and form as required by law.

(c) The Secretary of the Department shall certify this order and Annex A and deposit them with the Legislative Reference Bureau as required by law.

(d) This order shall take effect upon publication in the *Pennsylvania Bulletin* as final rulemaking.

FEATHER O. HOUSTOUN,  
*Secretary*

*(Editor's Note: For the text of the order of the Independent Regulatory Review Commission relating to this document, see 29 Pa.B. 2734 (May 22, 1999).)*

**Fiscal Note:** 14-441. (1) General Fund;

	<i>State</i>	<i>County</i>
(2) Implementing Year 1998-99 is	\$ 7.067 Million	\$1.902 Million;
(3) 1st Succeeding Year 1999-00 is	\$15.746 Million	\$3.936 Million;
2nd Succeeding Year 2000-01 is	\$16.297 Million	\$4.074 Million;
3rd Succeeding Year 2001-02 is	\$16.867 Million	\$4.217 Million;
4th Succeeding Year 2002-03 is	\$17.457 Million	\$4.364 Million;
5th Succeeding Year 2003-04 is	\$18.068 Million	\$4.517 Million;
	<i>State</i>	<i>County</i>
(4) 1997-98	\$398.740 Million	\$173.966 Million;
1996-97	\$354.863 Million	\$163.757 Million;
1995-96	\$264.743 Million	\$142.988 Million;

(7) Department of Public Welfare County Child Welfare; (8) recommends adoption. The State will pay the counties through the needs based budget for county services to children and youth. The counties are responsible for a portion of the cost of these services.

**Annex A**

**TITLE 55. PUBLIC WELFARE**

**PART V. CHILDREN, YOUTH AND FAMILIES MANUAL**

**Subpart D. NONRESIDENTIAL AGENCIES, FACILITIES AND SERVICES**

**ARTICLE III. COUNTY-ADMINISTERED SERVICES**

**CHAPTER 3480. (Reserved)**

§§ 3480.1—3480.4. (Reserved).

§§ 3480.11—3480.17. (Reserved).

**CHAPTER 3490. PROTECTIVE SERVICES**

**Subch.**

- A. CHILD PROTECTIVE SERVICES
- B. ABUSE OF STUDENTS IN SCHOOL
- C. GENERAL PROTECTIVE SERVICES
- D. GENERAL REQUIREMENTS FOR CHILD PROTECTIVE SERVICES AND GENERAL PROTECTIVE SERVICES

**Subchapter A. CHILD PROTECTIVE SERVICES**

**INTRODUCTION**

**Sec.**

- 3490.1. Applicability.
- 3490.2. Purposes.
- 3490.3. Legal base.
- 3490.4. Definitions.
- 3490.5. Waivers.

**REPORTERS**

- 3490.11. Reporting suspected child abuse.
- 3490.12. Required reporters.
- 3490.13. Reports by employees who are required reporters.
- 3490.14. Privileged communication.
- 3490.15. Taking a child into protective custody.
- 3490.16. Notifying the county agency.
- 3490.17. Notifying the child's parents, guardians or other custodians.
- 3490.18. Filing of a written report by a required reporter.
- 3490.19. Reporting to the coroner.
- 3490.20. Other medical information.
- 3490.21. Release of information on prior child abuse reports.

**DEPARTMENTAL RESPONSIBILITIES**

- 3490.31. Receipt of reports.
- 3490.32. ChildLine reporting to the county agency.
- 3490.33. Files.
- 3490.34. Pending complaint file.
- 3490.35. Statewide Central Register.
- 3490.36. Providing information to the county agency.
- 3490.37. Release of information: Statewide Central Register, pending complaint file and file of unfounded reports.
- 3490.38. Authorized studies of child abuse data.
- 3490.39. Expunction from the Statewide Central Register.
- 3490.40. Notifications regarding indicated reports.
- 3490.40a. Notifications regarding founded reports.
- 3490.41. Determination of time.
- 3490.42. Performance audit and reviews.
- 3490.43. (Reserved).

**COUNTY RESPONSIBILITIES**

- 3490.51. (Reserved).
- 3490.52. Receipt of reports.
- 3490.53. Functions of the county agency for child protective services.
- 3490.54. Independent investigation of reports.
- 3490.55. Investigation of reports of suspected child abuse.
- 3490.56. County agency investigation of suspected child abuse perpetrated by persons employed or supervised by child caring agencies and residential facilities.
- 3490.57. Protective custody.
- 3490.58. Notifications.
- 3490.59. Action by the county agency after determining the status of the report.
- 3490.60. Services available through the county agency.
- 3490.61. Supervisory review and child contacts.
- 3490.62. Repeated child abuse.
- 3490.63. (Reserved).
- 3490.64. (Reserved).
- 3490.65. (Reserved).
- 3490.66. (Reserved).
- 3490.67. Written reports to ChildLine.
- 3490.68. Retention of information on unfounded reports.
- 3490.69. Reports not received within 60 calendar days.
- 3490.70. Expunction and amendment of report by the county agency.
- 3490.71. Guardian ad litem and court designated advocate.
- 3490.72. (Reserved).
- 3490.73. Petitioning the court.

**CHILD ABUSE BY AGENTS OF THE COUNTY AGENCY**

- 3490.81. Responsibilities of the Department and the county agency.

**CONFIDENTIALITY**

- 3490.91. Persons to whom child abuse information shall be made available.
- 3490.92. Requests by and referrals to law enforcement officials.
- 3490.93. Requests by designated county officials.
- 3490.94. Release of the identity of a person who made a report of child abuse or cooperated in a subsequent investigation.
- 3490.95. Release of information to required reporters.

### GENERAL REQUIREMENTS FOR CHILD PROTECTIVE SERVICES

- 3490.101. Sanctions.  
 3490.102. Criminal liability for breach of confidentiality.  
 3490.103. Nonabuse reports received by the county agency or other public agency from ChildLine.  
 3490.104. Release of information to a subject of a report.  
 3490.105. Request by the subject of a founded or indicated report for expunction or amendment of an abuse report when the report was received by ChildLine prior to July 1, 1995.  
 3490.105a. Request by a perpetrator to amend or expunge an indicated report of child abuse received by ChildLine after June 30, 1995.  
 3490.106. Hearings and appeals proceedings for reports received by ChildLine prior to July 1, 1995.  
 3490.106a. Hearings and appeals proceedings for indicated reports received by ChildLine after June 30, 1995.  
 3490.107. Notification of Secretary's decision to amend or expunge a report of child abuse.  
 3490.108. Cooperation of county agencies and law enforcement agencies.  
 3490.109. Report from law enforcement agencies.

### VERIFICATION OF THE EXISTENCE OF CHILD ABUSE AND STUDENT ABUSE RECORDS FOR CHILD CARE SERVICES

- 3490.121. Definitions.  
 3490.122. Responsibilities of an applicant, prospective operator or legal entity of a child care service.  
 3490.123. Responsibilities of prospective adoptive parents, prospective foster parents, foster family care agencies and adoption investigators.  
 3490.124. Departmental procedures for replying to a request for verification.  
 3490.125. Voluntary certification of child caretakers.  
 3490.126. Sanctions.  
 3490.127. Information relating to prospective child care personnel.

### VERIFICATION OF THE EXISTENCE OF CHILD ABUSE AND STUDENT ABUSE RECORDS FOR SCHOOL EMPLOYEES

- 3490.131. Definitions.  
 3490.132. Responsibilities of an administrator.  
 3490.133. Responsibilities of an applicant.  
 3490.134. Information relating to prospective school employees.  
 3490.135. Responsibilities of the Department.  
 3490.136. Sanctions.

## INTRODUCTION

### § 3490.1. Applicability.

This chapter applies to the Department; other departments, boards, bureaus and agencies of the Commonwealth or any of its political subdivisions; county children and youth social service agencies and other agencies providing services to children and youth; law enforcement officials; county executive officers; auditors of the Federal government; public and nonpublic schools; intermediate units; area vocational-technical schools; independent school contractors; and persons who, in the course of their employment or occupation or in the practice of their profession, come into contact with children.

### § 3490.2. Purposes.

The purposes of this subchapter are to:

- (1) Protect abused children from further abuse.
- (2) Preserve and stabilize families.
- (3) Implement the CPSL.
- (4) Involve law enforcement agencies in responding to child abuse.
- (5) Prioritize the response and services to children most at risk.
- (6) Encourage more complete reporting of suspected child abuse.

### § 3490.3. Legal base.

The legal base of this chapter is the following statutory provisions:

- (1) Articles VII and IX of the Public Welfare Code (62 P. S. §§ 701—774 and 901—922).

(2) Chapter 63 of 42 Pa.C.S. (relating to the Juvenile Act).

(3) Section 2168 of the County Code (16 P. S. § 2168).

(4) Section 405 of the County Institution District Law (62 P. S. § 2305).

(5) The CPSL, 23 Pa.C.S. §§ 6301—6385 (relating to the Child Protective Services Law).

### § 3490.4. Definitions.

The following words and terms, when used in this chapter, have the following meanings, unless the context clearly indicates otherwise:

*Accept for service*—The county agency decides on the basis of the needs and problems of an individual to admit or receive the individual as a client of the agency or as required by a court order entered under the Juvenile Act.

*Agent of the county agency*—A person who provides a children and youth social service either directly or under contract or through agreement with a county agency.

(i) An agent of the county agency includes:

(A) Preadoptive parents.

(B) Foster parents.

(C) Staff and volunteers of public and private residential child care facilities.

(D) Staff and volunteers of public and private day care centers, group day care homes and family day care homes.

(E) Staff and volunteers of public and private social service agencies.

(F) Staff and volunteers of county detention centers.

(G) Persons residing in the home of foster or preadoptive parents.

(H) A school employe of a facility or agency that is an agent of a county agency.

(ii) The term does not include staff of Commonwealth-operated youth development centers and youth forestry camps.

*Arrange*—Make a service available to a client accepted for service through another agency or service provider which is not paid for by the county agency.

*Certified medical practitioner*—A licensed physician, a licensed physician's assistant or a certified registered nurse practitioner.

*CPSL*—The Child Protective Services Law, 23 Pa.C.S. §§ 6301—6385.

*Child*—A person under 18 years of age.

*Child abuse*—

(i) The term child abuse means any of the following:

(A) Any recent act or failure to act by a perpetrator which causes nonaccidental serious physical injury to a child.

(B) An act or failure to act by a perpetrator which causes nonaccidental serious mental injury to or sexual abuse or exploitation of a child.

(C) A recent act, failure to act or series of the acts or failures to act by a perpetrator which creates an imminent risk of serious physical injury to or sexual abuse or exploitation of a child.

(D) Serious physical neglect by a perpetrator constituting prolonged or repeated lack of supervision or the

failure to provide the essentials of life, including adequate medical care, which endangers a child's life or development or impairs the child's functioning.

(ii) A child will not be deemed to be physically or mentally abused based on injuries that result solely from environmental factors that are beyond the control of the parent or person responsible for the child's welfare, such as inadequate housing, furnishings, income, clothing and medical care.

(iii) If, upon investigation, the county agency determines that a child has not been provided needed medical or surgical care because of seriously held religious beliefs of the child's parents, guardian or person responsible for the child's welfare, which beliefs are consistent with those of a bona fide religion, the child will not be deemed to be physically or mentally abused. The county agency shall closely monitor the child and shall seek court-ordered medical intervention when the lack of medical or surgical care threatens the child's life or long-term health. In cases involving religious circumstances, all correspondence with a subject of the report and the records of the Department and the county agency may not reference "child abuse" and shall acknowledge the religious basis for the child's condition, and the family shall be referred for general protective services, under Subchapter C of the CPSL (relating to general protective services), if appropriate.

*ChildLine*—An organizational unit of the Department which operates a Statewide toll-free system for receiving reports of suspected child abuse established under section 6332 of the CPSL (relating to establishment of Statewide toll-free telephone number), refers the reports for investigation and maintains the reports in the appropriate file. In addition, it also receives reports of student abuse under Subchapter C.1 of the CPSL (relating to students in public and private schools).

*Child protective services*—Those services and activities provided by the Department and each county agency for child abuse cases.

*County agency*—

(i) The county children and youth social service agency established under section 405 of the County Institution District Law (62 P. S. § 2205), or its successor, and supervised by the Department under Article VII of the Public Welfare Code (62 P. S. §§ 701—774).

(ii) The term also includes the Department's Office of Children, Youth and Families' regional offices when the report of suspected child abuse or student abuse involves an agent of the county agency.

*County plan*—A needs-based plan and budget estimate which serves as the basis for administration of the county children and youth social services program required by Chapter 3140 (relating to planning and financial reimbursement requirements for county children and youth social service programs).

*Court designated advocate*—A trained citizen volunteer appointed by the court to advocate on behalf of dependent children and alleged dependent children involved in juvenile court proceedings.

*Crimes Code*—Title 18 of the *Pennsylvania Consolidated Statutes*.

*Department*—The Department of Public Welfare of the Commonwealth.

*Director of a hospital or other medical facility*—The director or a person specifically designated in writing by

the director to perform the functions under section 6315 of the CPSL (relating to taking child into protective custody) and this chapter.

*Expunge*—To strike out or obliterate entirely so that the stricken information may not be stored, identified or later recovered by any means—mechanical, electronic or otherwise.

*Family members*—Spouses, parents and children or other persons related by consanguinity or affinity. The term does not include foster parents, foster children and paramours.

*Founded report*—A child abuse report made under the CPSL and this chapter if there has been any judicial adjudication based on a finding that a child who is a subject of the report has been abused, including the entry of a plea of guilty or nolo contendere or a finding of guilt to a criminal charge involving the same factual circumstances involved in the allegation of child abuse.

*Indicated report*—A child abuse report made under the CPSL and this chapter if an investigation by the county agency or the Department determines that substantial evidence of the alleged abuse exists based on any of the following:

- (i) Available medical evidence.
- (ii) The child protective service investigation.
- (iii) An admission of the acts of abuse by the perpetrator.

*Individual residing in the same home as the child*—An individual who is 14 years of age or older and who resides in the same home as the child.

*Juvenile Act*—42 Pa.C.S. Chapter 63.

*Law enforcement official*—The term includes the following:

- (i) The Attorney General.
- (ii) A county district attorney.
- (iii) A State Police officer.
- (iv) A county sheriff.
- (v) A county police officer.
- (vi) A county detective.
- (vii) A local or municipal police officer.

*Medical evidence*—Evidence provided by a licensed health care professional, including a physician, nurse practitioner, registered nurse, psychiatrist or licensed psychologist.

*Paramour*—A person who is engaged in an ongoing intimate relationship with a parent of the child but is not married to and does not necessarily reside with the child's parent.

*Parent*—A biological parent, adoptive parent or legal guardian.

*Pending criminal court action*—The status assigned to a report when the county agency cannot complete the investigation within 30-calendar days because criminal court action has been initiated.

*Pending juvenile court action*—The status assigned to a report when the county agency cannot complete the investigation within 30-calendar days because juvenile court action has been initiated.

*Performance audit*—A review of a county agency's practices and implementation of the CPSL and this chapter by persons designated by the Secretary.

*Perpetrator*—A person who has committed child abuse and is a parent of a child, a person responsible for the welfare of a child, an individual residing in the same home as the child or a paramour of the child's parent.

*Person responsible for the child's welfare*—

(i) A person who provides permanent or temporary care, supervision, mental health diagnosis or treatment, training or control of a child in lieu of parental care, supervision and control.

(ii) The term does not include a person who is employed by or provides services or programs in a public or private school, intermediate unit or area vocational-technical school.

*Physician*—A person licensed under the statutes and regulations of the Commonwealth to practice medicine.

*Protective services*—Services and activities provided by the Department and each county agency for children who are abused or in need of general protective services under this chapter.

*Provide*—To perform an activity directly through county agency staff or ensure the performance of an activity through a purchase of service agreement with another agency or individual.

*Recent act or failure to act*—An act or failure to act committed within 2 years of the date of the report of suspected child abuse to the Department or county agency.

*Regional staff*—Department employees who license and monitor public and private children and youth social service agencies and facilities within a specific geographical area of this Commonwealth.

*Required reporters*—

(i) Persons who, in the course of their employment, occupation or practice of their profession come into contact with children and have reasonable cause to suspect, on the basis of their medical, professional or other training and experience, that a child coming before them in their professional or official capacity is a victim of child abuse.

(ii) Except with respect to confidential communications made to an ordained member of the clergy which are protected under 42 Pa.C.S. § 5943 (relating to confidential communications to clergymen), the privileged communication between any professional person required to report and the patient or client of that person does not apply to situations involving child abuse and does not constitute grounds for failure to report as required by this subchapter.

(iii) Persons required to report include:

(A) A licensed physician, medical examiner, coroner, funeral director, dentist, optometrist, osteopath, chiropractor, psychologist, podiatrist, intern, registered nurse or licensed practical nurse.

(B) Hospital personnel engaged in the admission, examination, care or treatment of persons.

(C) A Christian Science practitioner, member of the clergy, school administrator, school teacher, school nurse, social services worker, day care center worker or another child care or foster care worker, mental health professional, peace officer or law enforcement official.

*Secretary*—The Secretary of the Department or a person specifically designated in writing by the Secretary to perform the Secretary's functions under the CPSL and this chapter.

*Serious bodily injury*—Injury which creates a substantial risk of death or which causes serious permanent disfigurement or protracted loss or impairment of the function of a body member or organ.

*Serious mental injury*—A psychological condition as diagnosed by a physician or licensed psychologist, including the refusal of appropriate treatment, that does either of the following:

(i) Renders the child chronically and severely anxious, agitated, depressed, socially withdrawn, psychotic or in reasonable fear that the child's life or safety is threatened.

(ii) Seriously interferes with the child's ability to accomplish age-appropriate developmental and social tasks.

*Serious physical injury*—An injury that does either of the following:

(i) Causes the child severe pain.

(ii) Significantly impairs the child's physical functioning, either temporarily or permanently.

*Serious physical neglect*—A physical condition caused by the act or failure to act of a perpetrator which endangers the child's life or development or impairs the child's functioning and is the result of one of the following:

(i) Prolonged or repeated lack of supervision.

(ii) Failure to provide essentials of life, including adequate medical and dental care.

*Sexual abuse or exploitation*—

(i) Any of the following if committed on a child by a perpetrator:

(A) The employment, use, persuasion, inducement, enticement or coercion of a child to engage in or assist another person to engage in sexually explicit conduct.

(B) A simulation of sexually explicit conduct for the purpose of producing a visual depiction, including photographing, videotaping, computer depicting or filming, of sexually explicit conduct.

(C) Any of the following offenses as defined by the crimes code:

(1) Rape as defined by section 3121 (relating to rape).

(2) Statutory sexual assault as defined by section 3122.1 (relating to statutory sexual assault).

(3) Involuntary deviate sexual intercourse as defined by section 3123 (relating to involuntary deviate sexual intercourse).

(4) Sexual assault as defined by section 3124.1 (relating to sexual assault).

(5) Aggravated indecent assault as defined by section 3125 (relating to aggravated indecent assault).

(6) Indecent assault as defined by section 3126 (relating to indecent assault).

(7) Indecent exposure as defined by section 3127 (relating to indecent exposure).

(8) Incest as defined by section 4302 (relating to incest).



(9) Prostitution as defined by section 5902 (relating to prostitution and related offenses).

(D) Exploitation which includes any of the following:

(1) Looking at the sexual or other intimate parts of a child for the purpose of arousing or gratifying sexual desire in either person.

(2) Engaging or encouraging a child to look at the sexual or other intimate parts of another person for the purpose of arousing or gratifying sexual desire in any person involved.

(3) Engaging or encouraging a child to participate in sexually explicit conversation either in person, by telephone, by computer or by a computer aided device.

*Statewide Central Register*—A register of child abuse and student abuse, established in the Department, which consists of founded and indicated reports of child abuse and student abuse.

*Status determination*—The decision made by the county agency that a child abuse or student abuse report is founded, indicated, unfounded, pending juvenile court action or pending criminal court action.

*Subjects of the report*—A child, parent, guardian or other person responsible for the welfare of a child or any alleged or actual perpetrator or school employe named in a report made to the Department or county agency under this subchapter.

*Substantial evidence*—Evidence which outweighs inconsistent evidence and which a reasonable person would accept as adequate to support a conclusion.

*Unfounded report*—A report made under the CPSL and this chapter unless the report is a founded report or an indicated report.

**§ 3490.5. Waivers.**

(a) A waiver of a requirement of this chapter may be requested as specified in procedures published by the Department.

(b) A waiver may be granted by the Department if the waiver:

(1) Does not alter the applicability, scope or purpose of this chapter.

(2) Is based on evidence, supplied by the requesting county agency, that the objective of the requirement will be achieved in another way.

(3) Is based on evidence, supplied by the requesting county agency, that a waiver will have no adverse effect on the health, safety and rights of children.

(4) Does not violate or condone noncompliance with Federal statutes or regulation or State statutes.

(5) Does not jeopardize receipt of Federal moneys.

(c) Except as provided in section 6361 of the CPSL (relating to organization for child protective services), the Department may not waive the requirement that the county agency is the sole civil agency responsible to receive and investigate reports of suspected child abuse and receive and assess reports of suspected neglect.

(d) A county agency requesting a waiver shall continue to comply with the requirements of this chapter until a waiver is granted.

**REPORTERS**

**§ 3490.11. Reporting suspected child abuse.**

(a) A person may make a report of suspected child abuse to ChildLine or a county agency if the person has

reasonable cause to suspect that a child has been abused. Reports shall be accepted by ChildLine or the county agency regardless of whether the person identifies himself.

(b) A person other than a school employe having reasonable cause to suspect that a school employe has committed student abuse may report the suspected abuse to the school administrator as required by §§ 3490.151(c) and 3490.152(a) and (c) (relating to required reporting; and responsibilities of administrators and school employes).

**§ 3490.12. Required reporters.**

In addition to other reports they make, required reporters shall report suspected child abuse to ChildLine.

**§ 3490.13. Reports by employes who are required reporters.**

(a) Required reporters who work in an institution, school, facility or agency shall immediately notify the person in charge of the institution, school, facility or agency or the person in charge's designee of suspected abuse. The person in charge, or the designee, shall be responsible and have the obligation to make a report of the suspected child abuse to ChildLine immediately. Nothing in this chapter requires more than one report from any institution, school, facility or agency.

(b) The person in charge or the designee may not make an independent determination of whether to report. The person in charge or the designee shall notify the employe when the report was made to ChildLine.

(c) Notwithstanding subsection (a), nothing in this chapter prohibits an employe who is a required reporter from making a report directly to ChildLine.

**§ 3490.14. Privileged communication.**

Except with respect to confidential communications made to an ordained member of the clergy which are protected under 42 Pa.C.S. § 5943 (relating to confidential communications to clergymen), privileged communication between a required reporter and the person's patient or client does not apply to situations involving child abuse and may not constitute grounds for failure to report as required by this chapter.

**§ 3490.15. Taking a child into protective custody.**

(a) The following persons may take a child into protective custody:

(1) Persons authorized to do so under section 6324 of the Juvenile Act (relating to taking into custody).

(2) The director or a person specifically designated in writing by the director of a hospital or other medical facility or a physician examining or treating a child under section 6315 of the CPSL (relating to taking child into protective custody) and subsection (b).

(b) The director or a person specifically designated in writing by the director or physician may take a child into protective custody if it is immediately necessary to protect the child from further serious physical injury, sexual abuse, or serious physical neglect—as indicated by the following examples:

(1) Medical indications of repeated abuse, the existence of previous indicated or founded reports of child abuse, the seriousness of the child's condition, evidence of recent acts of abuse as opposed to old injuries, or statements of the child, or statements or actions by the parents indicating they are likely to be abusive toward the child.

(2) There is medical evidence that the child is a victim of alleged child abuse and that the child's physical condition constitutes a medical emergency which requires immediate hospitalization to prevent death or serious physical impairment.

(3) The parents, guardians or other custodians, after being advised that the child's physical condition constitutes a medical emergency will make no immediate arrangements for medically adequate alternative treatment.

(c) A child may not be held in protective custody for more than 24 hours unless the appropriate county agency is immediately notified that the child has been taken into protective custody and the county agency obtains a court order permitting the child to be held in protective custody for a longer period of time.

**§ 3490.16. Notifying the county agency.**

If a person takes a child suspected of being abused into protective custody, the person shall immediately notify the county agency in the county where the child is being held that the child is in protective custody.

**§ 3490.17. Notifying the child's parents, guardians or other custodians.**

If a person takes a child into protective custody, the person shall verbally notify the child's parents, guardians or other custodians immediately and in writing within 24 hours, of the following:

- (1) The child's whereabouts unless prohibited by a court order.
- (2) The reason for taking the child into protective custody.
- (3) The telephone number of the local county agency.

**§ 3490.18. Filing of a written report by a required reporter.**

Within 48 hours of reporting to ChildLine, a required reporter shall make a written report on forms provided by the Department to the county agency in the county where the suspected child abuse occurred. The written report shall include the following information, if available:

- (1) The names and addresses of the child and the parents or other persons responsible for the care of the child.
- (2) The county in which the suspected abuse occurred.
- (3) The age and sex of the subjects of the report.
- (4) The nature and extent of the suspected child abuse, including evidence of prior abuse to the child or a sibling.
- (5) The reasons for suspecting child abuse.
- (6) The name of the alleged perpetrators of the suspected abuse and evidence of prior abuse by those persons.
- (7) The relationship of the alleged perpetrator to the child.
- (8) The family household composition.
- (9) The source of the report.
- (10) The person making the report and where the person can be reached.
- (11) A statement of the child's parents regarding the suspected abuse and a statement or admission of abuse by the alleged perpetrator.

(12) The actions taken by the reporting source, including:

- (i) The taking of photographs and X-rays.
- (ii) The taking of protective custody.
- (iii) Notification to the coroner.
- (iv) The hospitalization of the child.

**§ 3490.19. Reporting to the coroner.**

A required reporter who suspects that a child died as a result of child abuse shall send a duplicate of the report sent to the county agency to the coroner of the county in which the death occurred.

**§ 3490.20. Other medical information.**

A required reporter may photograph a child who is the subject of a report and, if clinically indicated, ensure that a radiological examination and other medical tests of the child are performed. A medical summary or report of photographs or X-rays taken shall be sent to the county agency at the time the written report is sent, or as soon thereafter as possible. The county agency shall be provided access to the actual photographs and X-rays and may obtain them or duplicates upon request.

**§ 3490.21. Release of information on prior abuse reports.**

(a) A physician or director or a person specifically designated in writing by the director of a hospital or other medical facility may request information from the county agency on prior abuse involving the child being examined or treated by the physician or director or a person specifically designated in writing by the director of the hospital or other medical facility.

(b) The county agency shall provide the physician or director or the designee of the director treating or examining the child with the requested information on prior child abuse involving the child.

**DEPARTMENTAL RESPONSIBILITIES**

**§ 3490.31. Receipt of reports.**

The Department established a single Statewide toll-free telephone number (800) 932-0313—referred to as ChildLine—available at all times to receive reports of suspected child abuse.

**§ 3490.32. ChildLine reporting to the county agency.**

(a) ChildLine shall immediately transmit reports of suspected child abuse verbally to the county agency of the county where the suspected abuse occurred. If the child resides in a different county, ChildLine will notify that county also.

(b) If the child was allegedly abused in more than one county or on an ongoing basis, ChildLine will assign the report to the county where the most recent alleged abuse occurred.

(c) The county agency which receives the report initially is responsible to contact the other counties in subsections (a) and (b) in conducting the investigation. If it appears that a county other than the one to which the report was referred should conduct the investigation, the agencies should decide between themselves which one is responsible for the report. The county which received the report initially shall notify ChildLine of any change so that ChildLine's records are accurate and up-to-date.

(d) If the counties are unable to agree about which one is responsible to conduct the investigation and make the

status determination, the county to which the report was assigned shall contact ChildLine and Childline will assign the investigation to a county agency to make a status determination.

(e) The report of the investigation shall be submitted to ChildLine within 30-calendar days of when the report was received at ChildLine.

(f) The ChildLine report to the county agency shall contain the information on the current report of suspected abuse and the information on file at ChildLine on previous reports except for information obtained by the Department as a result of a request to expunge an indicated or founded report of child abuse or an indicated report of student abuse.

(g) If the complaint received does not suggest suspected child abuse but does suggest a need for social services or other services or investigation, ChildLine shall transmit the information to the appropriate county agency or other public agency.

**§ 3490.33. Files.**

ChildLine will establish and maintain the following files for reports of child abuse:

(1) A pending complaint file which contains reports of child abuse that are one of the following:

- (i) Under investigation.
- (ii) Pending juvenile or criminal court action.

(2) A Statewide Central Register which contains the following:

- (i) Copies of founded and indicated reports of child abuse.
- (ii) A subfile of the names of perpetrators of indicated and founded reports of child abuse if the individual's Social Security Number or date of birth is known to the Department. The subfile shall be retained indefinitely.

(3) A statistical file which contains copies of reports of suspected, indicated and founded reports of child abuse after information which could directly or indirectly identify a subject of a report has been expunged.

(4) A file of unfounded reports awaiting expunction.

**§ 3490.34. Pending complaint file.**

(a) Upon receipt of a report of suspected child abuse ChildLine will enter the information specified in section 6336 of the CPSL (relating to information in Statewide Central Register) into the pending complaint file.

(b) Notwithstanding subsection (c), reports which are determined pending juvenile or criminal court action shall be maintained in the pending complaint file until the county agency notifies ChildLine of the final status.

(c) If within 60 calendar days from the date of the initial report of suspected child abuse a status determination has not been received at ChildLine, the report shall be considered unfounded. Prior to expunging the report, ChildLine shall verify with the county agency that the report was not completed within 60-calendar days.

(d) Unfounded reports shall be expunged at ChildLine within 120-calendar days after the date of the initial report to ChildLine.

(e) Reports which are unfounded awaiting expunction may not be released from the pending complaint file except to a subject of a report upon written request, employees of the Department under this subchapter and

employees of the Office of Attorney General under section 6345 of the CPSL (relating to audits by Attorney General).

**§ 3490.35. Statewide Central Register.**

When a report of suspected child abuse is determined founded or indicated, ChildLine shall enter the report in the Statewide Central Register and expunge the report from the pending complaint file. If there is incomplete information in the report, ChildLine will contact the county agency and request additional clarifying information so that the information in the Statewide Central Register is complete.

**§ 3490.36. Providing information to the county agency.**

(a) ChildLine shall release information to a county agency verbally only when both of the following exist:

- (1) The county agency is making a report of suspected child abuse.
- (2) ChildLine has identified that the person is a representative of the county agency.

(b) When ChildLine receives a verbal request from a county agency, only the information specified in § 3490.32(f) (relating to ChildLine reporting to the county agency) may be released from the pending complaint file and Statewide Central Register.

(c) Upon receipt of a written request from the county agency for information regarding a subject of a report, ChildLine will forward copies of all reports on file which are under investigation, founded or indicated involving that subject to the county agency, except information obtained by the Department in response to a request to amend or expunge an indicated or founded report of child abuse.

**§ 3490.37. Release of information: Statewide Central Register, pending complaint file and file of unfounded reports.**

(a) A request for information from the Statewide Central Register, pending complaint file or file of unfounded reports by persons permitted access to this information, other than the county agency, shall be in writing and signed by the person requesting the information.

(b) The name of the person who made the report or who cooperated in the investigation may be released only by the Secretary.

**§ 3490.38. Authorized studies of child abuse data.**

The Department may conduct or authorize studies of the data contained in the pending complaint file, the Statewide Central Register, the statistical file, and the county agency files and distribute the results of the studies if no study contains the name of a subject or other information by which a subject of a report can be directly or indirectly identified. Requests to conduct studies shall be made to the Deputy Secretary, Office of Children, Youth and Families of the Department. The researcher shall secure the concurrence of the appropriate county agency administrator to use the county agency files.

**§ 3490.39. Expunction from the Statewide Central Register.**

(a) Except as provided in subsection (b), ChildLine shall expunge founded and indicated reports when a subject child is 23 years of age or older.

(b) If the Social Security Number or date of birth of the perpetrator is known in founded or indicated reports of child abuse, the following information shall be maintained:

(1) The name, Social Security Number, date of birth and sex of the perpetrator.

(2) The date of birth and sex of the child.

(3) The dates and the nature and extent of the child abuse.

(4) The county in which the child abuse occurred.

(5) The relationship of the perpetrator to the child.

(6) Whether the report was a founded or indicated report.

(7) The results of any criminal prosecution.

(c) The information referred to in subsection (b) shall remain in the subfile under § 3490.33 (relating to files).

**§ 3490.40. Notifications regarding indicated reports.**

(a) When indicated reports of child abuse are entered into the Statewide Central Register, ChildLine will notify all subjects by first class mail, other than the subject child, of:

(1) The status of the report.

(2) The perpetrator's right to request the Secretary to amend or expunge the report.

(3) The circumstances under which the report will be expunged.

(4) Their right to services from the county agency.

(5) The effect of the report upon future employment opportunities in a child care service.

(6) The fact that the name of the perpetrator and nature of the abuse will be kept on file indefinitely if the Social Security Number or date of birth of the perpetrator is known.

(b) ChildLine will notify the county agency and the perpetrator of any expunction of a report of child abuse, except when the expunction is the result of the Secretary's decision, in which case the county agency and all subjects shall be notified.

(c) ChildLine will notify the county agency and all subjects of the Secretary's decision to amend a report of child abuse.

**§ 3490.40a. Notifications regarding founded reports.**

When founded reports of child abuse are entered into the Statewide Central Register, ChildLine will notify all subjects by first class mail, other than the subject child, of:

(1) The status of the report.

(2) The effect of the report upon future employment opportunities in a child care service and a school.

(3) The fact that the name of the perpetrator or school employe and nature of the abuse will be kept on file indefinitely if the Social Security Number or date of birth of the perpetrator or school employe is known.

**§ 3490.41. Determination of time.**

ChildLine will use the United States Postal Service postmark or the date received by the Department when transmitted electronically to determine when the Department is informed by the county agency of the status determination of a report.

**§ 3490.42. Performance audit and reviews.**

(a) The Secretary may direct that a performance audit be conducted of any activity related to the implementation of the CPSL and this chapter.

(b) The Department will determine in its annual licensing and inspection process whether the county agency has sufficiently documented reasons why, if applicable, all child abuse investigations have not been completed within the 30-calendar day period.

(c) The Department will provide the results of performance audits and reviews to the affected agencies consistent with the confidentiality provisions of this chapter. Information provided shall include an assessment of compliance with the provisions of this chapter and recommendations relating to practice issues, if appropriate.

**§ 3490.43. (Reserved).**

**COUNTY RESPONSIBILITIES**

**§ 3490.51. (Reserved).**

**§ 3490.52. Receipt of reports.**

The county agency shall provide 24-hours-per-day/7-days-per-week telephone access for persons to report suspected child abuse.

**§ 3490.53. Functions of the county agency for child protective services.**

(a) The county agency is the sole civil agency responsible for receiving and investigating reports of child abuse except reports of abuse allegedly perpetrated by an agent. The county agency shall investigate allegations of abuse of children residing in facilities operated directly by the Department.

(b) The county agency shall protect the safety of the subject child and other children in the home or facility and shall provide or arrange appropriate services when necessary during the investigation period.

(c) The county agency shall determine the status of reports of suspected child abuse.

(d) If the county agency concludes that the child is in danger of further child abuse, the county agency shall do the following:

(1) Accept the case for service.

(2) Provide direct case management.

(3) Monitor the provision of services, whether provided directly by the county agency or through purchase or agreement.

(e) The county agency shall provide direct case management of services provided to abused children and their families until the county agency is reasonably assured that the child is no longer in danger of child abuse. The reasons for termination of the county agency involvement shall be recorded in the case record.

**§ 3490.54. Independent investigation of reports.**

Except for reports investigated by the Department, the county agency shall investigate and make independent determinations on reports of suspected child abuse, regardless of another investigation conducted by another agency, the court or the police and regardless of whether or not the person making the report identified himself. A county agency may rely on an investigation of substantially the same allegations by a law enforcement agency to support the county agency's finding regarding a child abuse report. This reliance does not limit the duties

required of the county agency by section 6368 of the CPSL (relating to investigation of reports).

**§ 3490.55. Investigation of reports of suspected child abuse.**

(a) Except as provided in subsection (b), the county agency shall begin its investigation within 24 hours of receiving a report of suspected child abuse. Upon beginning its investigation, the county agency shall see the child within 24 hours of receipt of the report.

(b) The county agency shall begin the investigation immediately upon receipt of a report of suspected child abuse and see the child immediately if one of the following applies:

- (1) Emergency protective custody has been taken or is needed.
- (2) It cannot be determined from the report whether or not emergency protective custody is needed.
- (c) After ensuring the immediate safety of the child and other children in the home, the county agency shall verbally notify ChildLine of the receipt of the report, if it was not received initially from ChildLine.

(d) When conducting its investigation, the county agency shall, if possible, conduct an interview with those persons who are known to have or may reasonably be expected to have, information relating to the incident of suspected child abuse including, but not limited to, all of the following:

- (1) The child, if appropriate.
- (2) The child's parents or other person responsible for the child's welfare.
- (3) The alleged perpetrator of the suspected child abuse.
- (4) The reporter of the suspected child abuse, if known.
- (5) Eyewitnesses to the suspected child abuse.
- (6) Neighbors and relatives who may have knowledge of the abuse.
- (7) Day care provider or school personnel, or both, if appropriate.

(e) The county agency shall record in writing the facts obtained as a result of the interviews conducted under subsection (d) and any other interviews it conducts.

(1) When conducting its investigation, the county agency shall maintain a written record of the facts obtained from each interview it conducts.

(2) At the conclusion of its investigation, when the report is determined indicated, founded or unfounded and accepted for services, under § 3490.59 (relating to action by the county agency after determining the status of the report), the county agency shall enter a written summary of the facts obtained from each interview in the case record.

(f) When investigating a report of suspected child abuse in which a child has sustained visible injury, the county agency shall, whenever possible and appropriate, take, cause to be taken or obtain color photographs of the injury.

(1) Photographs shall include one snapshot in which the child is clearly identifiable with the injured part of the body visible to establish the identity of the child and the actual location and extent of the injury. More than one photograph of the injury shall be taken if it is necessary to obtain a clear close-up of the injury.

(2) The county agency shall maintain photographs it secures in the case record. Photographs shall be identified by all of the following:

- (i) The name of the child.
- (ii) The age of the child.
- (iii) The date and time of day the photograph was taken.
- (iv) The location at which the photograph was taken.
- (v) The names of witnesses present.
- (vi) The name of the photographer.

(g) When investigating a report of suspected serious mental injury, sexual abuse or exploitation or serious physical neglect, the county agency shall, whenever appropriate, obtain medical evidence or expert consultation, or both. The county agency shall maintain a record of medical evidence or expert consultation, or both, obtained during its investigation, including one of the following:

- (1) The reasons why medical examination or expert consultation, or both, was secured and the results of the examination/consultation.
- (2) The reasons why medical examination or expert consultation, or both, was determined not to be necessary.

(h) If the investigation indicates serious physical injury, a medical examination shall be performed on the subject child by a certified medical practitioner. If there is reasonable cause to suspect there is a history of prior or current abuse, the medical practitioner has the authority to arrange for further medical tests or the county agency has the authority to request further medical tests.

(i) When conducting its investigation, the county agency shall visit the child's home, at least once during the investigation period. The home visits shall occur as often as necessary to complete the investigation and to assure the safety of the child.

(j) When investigating cases of suspected child abuse and a subject is located in a county other than where the abuse occurred, the county agency shall either make contact in the county where the subject is located or request the county where the subject is located to conduct the interview. The county agency where the subject is located shall assist in the investigation as required by this section.

**§ 3490.56. County agency investigation of suspected child abuse perpetrated by persons employed or supervised by child care services and residential facilities.**

(a) In addition to complying with other applicable sections of the CPSL and this chapter, when investigating a report of suspected child abuse perpetrated by a person who operates, is employed by or acting as a volunteer for a child care service, including a child day care center, a group or family day care home or a residential facility, the county agency, shall, within 24 hours of receipt of the report, verbally notify the following of the content of the report:

- (1) The person in charge of the facility or child care service where the alleged child abuse occurred.
- (2) The person in charge of the agency which placed the child.
- (3) The person in charge of the county agency with custody or supervision of the child.

(4) The regional office of the Department that is responsible to license, register or approve the child care service or facility.

(b) The person in charge of the child care service or facility shall implement a plan of supervision or alternative arrangements to ensure the safety of the child and other children who are in the care of the child care service or facility during the investigation. The plan of supervision or alternative arrangements shall be in writing, approved by the county agency and kept on file by the county agency until the investigation is completed. When the plan is approved by the county agency, the county agency shall immediately send a copy of the approved plan to the appropriate regional licensing director or designee.

(c) The county agency shall inform the persons listed in subsection (a) in writing of the results of the investigation.

(d) The county agency shall develop or revise the family service plan as required by Chapter 3130 (relating to administration of county children and youth social service programs) for the child and perpetrator if the report is founded or indicated and the case has been accepted for service.

(e) If the report is founded or indicated, the county agency shall request a written statement from the person in charge of the child care service or facility regarding the steps planned and taken to ensure the future safety of the subject child and other children in the care of the child care service or facility. The request shall be made within 5-calendar days of when the status determination was made. The person in charge of the child care service or facility shall submit a written response to the county agency within 10-calendar days of the mailing date of the county agency's letter. If the plan is unacceptable to the county agency, the county agency shall take appropriate action to ensure the safety of the children in the child care service or facility.

(f) If the facility or child care service is operated, registered, licensed or approved by the Department, the county agency shall send a copy of the completed form required by § 3490.67 (relating to written reports to ChildLine)—filed with ChildLine—and a copy of the written statement required by subsection (e) to the regional director or the director's designee in the region where the founded or indicated child abuse occurred.

#### § 3490.57. Protective custody.

(a) The county agency shall comply with the Juvenile Act, the CPSL and this chapter when taking a child into custody. Protective custody under this chapter may not be maintained longer than 72 hours without an informal hearing under section 6332 of the Juvenile Act (relating to informal hearing). If, at the informal hearing, it is determined that protective custody shall be continued and the child is alleged to be a dependent child under section 6302 of the Juvenile Act (relating to definitions), the county agency shall within 48 hours of the determination file a petition with the court under the Juvenile Act alleging that the child is a dependent child.

(b) The county agency shall request protective custody only if the immediate safety and well-being of the child requires removal from the setting in which the alleged child abuse occurred.

(c) A county agency worker may take a child into protective custody only under a specific court order naming the individual child. The county agency staff may

not be deputized or use blanket court orders to take children into protective custody.

(d) A child taken into protective custody may be placed only in the following locations:

(1) A hospital, if hospitalization is medically necessary in the opinion of the attending physician.

(2) A home of a relative of the child or other individual who has a significant relationship with the child or the child's family. The home shall be approved by the county agency for this purpose.

(3) A foster family home approved by a licensed foster family care agency.

(4) A licensed residential child care facility.

(e) If the county agency initiates emergency protective custody, it shall notify the child's parents as required by § 3490.17 (relating to notifying the child's parents, guardians or other custodians).

(f) Within 48 hours of taking a child into protective custody, the county agency shall do the following:

(1) Meet with the child's parents to assess their ability to assure the child's safety if the child is to be returned home.

(2) Meet with other individuals who may have information relating to the safety of the child in the home if the child is to be returned home.

(3) Determine if services could be provided to the family which would alleviate the conditions necessitating protective custody.

(4) Provide or arrange for necessary services.

(5) Meet with the parents to advise them of the decision to do one of the following:

(i) Return the child to the child's home.

(ii) Explain to the parents the reasons why the child will continue to be held in protective custody and the nature of future legal proceedings including the rights provided under sections 6337 and 6338 of the Juvenile Act (relating to right to counsel; and other basic rights) which are:

(A) The right to counsel.

(B) The right to introduce evidence and cross examine witnesses at the Juvenile Court hearing.

#### § 3490.58. Notifications.

(a) Except for the subject child, the county agency shall notify the subject who is about to be interviewed of:

(1) The existence of the report and the type of suspected abuse.

(2) The subject's rights under sections 6337 and 6338 of the Juvenile Act (relating to right to counsel; and other basic rights) when a case goes to Juvenile Court. Those rights are:

(i) The right to counsel.

(ii) The right to introduce evidence and cross examine witnesses.

(3) The perpetrator's rights regarding amendment and expunction.

(b) Within 72 hours of interviewing the subject, the county agency shall notify the subject in writing of:

(1) The existence of the report and type of alleged abuse.

(2) The rights under sections 6337 and 6338 of the Juvenile Act, when a case goes to juvenile court. Those rights are:

- (i) The right to counsel.
- (ii) The right to introduce evidence and cross examine witnesses.
- (3) The perpetrator's rights regarding amendment and expunction.
- (4) The right to obtain a copy of the report from the Statewide Central Register or the county agency.
- (5) The fact that the report, if determined unfounded, will be expunged from the pending complaint file within 120-calendar days from the date the report was received at ChildLine.
- (6) The purpose of the law, the implications of the status determination of the report and the services available through the county agency.

(7) The effect that a founded or indicated report of child abuse will have on a person seeking employment in a child care service or in a school.

(8) That the agency has, will or may make a report to law enforcement officials.

(c) The written notice required by subsection (b) may be reasonably delayed if notification is likely to threaten the safety of the victim, the safety of a nonperpetrator subject or the safety of an investigating county agency worker, to cause the perpetrator to abscond or to significantly interfere with the conduct of a criminal investigation. The written notice shall be provided to all subjects prior to the county agency determining the status of the report and regardless of where the person lives.

(d) Except for the subject child, the county agency shall notify all subjects in writing of one of the following when the county agency determines that the report is unfounded:

- (1) The information will be kept on file at the county agency and clearly identified as an unfounded report of suspected child abuse when the family has been accepted for services.
- (2) The report is unfounded and because the family has not been accepted for services that all information will be expunged at the county agency upon notification from ChildLine and that the report will be expunged from the pending complaint file within 120-calendar days of receipt of the report at ChildLine.
- (e) The county agency shall provide the notification required under subsection (d) when it notifies ChildLine of the status of the report.

**§ 3490.59. Action by the county agency after determining the status of the report.**

(a) If the report is determined founded, indicated or unfounded and the family has been accepted for service, the county agency shall develop and implement a family service plan and conduct plan reviews under Chapter 3130 (relating to administration of county children and youth social service programs).

(b) If the report is unfounded and not accepted for services but the family is in need of services, other than those provided by the county agency, the county agency shall advise the subjects of the services available.

**§ 3490.60. Services available through the county agency.**

In addition to those services required in Chapter 3130 (relating to administration of county children and youth

social service programs) the county agency shall provide, arrange or otherwise make available the following services for the prevention and treatment of child abuse:

- (1) Emergency medical services which include appropriate emergency medical care for examination, evaluation and treatment of children suspected of being abused.
- (2) Self-help groups to encourage self-treatment of present and potential abusers.
- (3) Multidisciplinary teams composed of professionals from a variety of disciplines who are consultants to the county agency in its case management responsibilities as required by Chapter 3130 who perform one of the following functions:
  - (i) Pool their knowledge and skills to assist the county agency in diagnosing child abuse.
  - (ii) Provide or recommend comprehensive coordinated treatment.
  - (iii) Periodically assess the relevance of the treatment and the progress of the family.

(iv) Participate in the State or local child fatality review team authorized under section 6340(a)(4) and 6343(b) of the CPSL (relating to release of information in confidential reports; and performance audit), convened by a professional, organization and the county agency for the purpose of investigating a child fatality or the development and promotion of strategies to prevent child fatality.

**§ 3490.61. Supervisory review and child contacts.**

(a) The county agency supervisor shall review each report of suspected child abuse which is under investigation on a regular and ongoing basis to ensure that the level of services are consistent with the level of risk to the child, to determine the safety of the child and the progress made toward reaching a status determination. The supervisor shall maintain a log of these reviews which at a minimum shall include an entry at 10-calendar day intervals during the investigation period.

(b) When a case has been accepted for service and a family service plan has been developed under Chapter 3130 (relating to the administration of county children and youth social service programs), the county agency supervisor shall, within 10-calendar days of the completion of the family service plan, review the plan to assure that the level of activity, in person contacts with the child, oversight, supervision and services for the child and family contained in the plan, are consistent with the level of risk determined by the county agency for the case. Documentation of this review shall be in the case record.

(c) When a case has been accepted for service, the county agency shall monitor the safety of the child and assure that contacts are made with the child, parents and service providers. The contacts may occur either directly by a county agency worker or through purchase of service, by phone or in person but face-to-face contacts with the parent and the child must occur as often as necessary for the protection of the child but no less often than:

- (1) Once a week until the case is no longer designated as high risk by the county agency, if the child remains in or returns to the home in which the abuse occurred and the county agency has determined a high level of risk exists for the case.
- (2) Once a month for 6 months or case closure when the child is either:

(i) Placed out of the home or setting in which the abuse occurred.

(ii) Not at a high risk of abuse or neglect.

(d) A periodic assessment of the risk of harm to the child shall be conducted as required by the State-approved risk assessment process.

(e) The county agency shall monitor the provision of services and evaluate the effectiveness of the services provided under the family service plan under § 3130.63 (relating to review of family service plans). The county agency worker shall visit the family in performing the case management responsibilities as required by § 3130.63 as often as necessary for management of the services provided but at least every 180-calendar days.

(f) The family service plan shall contain a provision that requires the parents advise the county agency, within 24 hours, when the child or family move from one residence to another.

**§ 3490.62. Repeated child abuse.**

If the child is a victim of one substantiated incident of child abuse and the county agency receives a subsequent report of suspected child abuse, the county agency administrator or supervisor shall arrange for a review by the multidisciplinary team as required by § 3490.60 (relating to services available through the county agency). Prior to the meeting with the multidisciplinary team, the agency administrator or designee, the supervisor and caseworker shall review the family service plan and make a recommendation to the multidisciplinary team on the appropriateness of the family service plan and whether additional or different services are necessary to protect the child. The county agency shall modify the family service plan, if necessary and appropriate, to reflect the recommendations of the multidisciplinary team and implement action necessary to fulfill the recommendations.

**§ 3490.63. (Reserved).**

**§ 3490.64. (Reserved).**

**§ 3490.65. (Reserved).**

**§ 3490.66. (Reserved).**

**§ 3490.67. Written reports to ChildLine.**

(a) The county agency shall send the Child Protective Service Investigation Report form (CY-48) to ChildLine within 30-calendar days of the receipt of the report of suspected child abuse.

(b) To avoid expunction of a case as required by § 3490.69 (relating to reports not received within 60-calendar days) when a status determination cannot be made and the county agency has petitioned the juvenile court, an arrest has been made or there is criminal court action pending, the county agency shall send a copy of the CY-48 to Childline with one of the following status determinations:

(1) Pending juvenile court action.

(2) Pending criminal court action.

(3) Indicated, when there is substantial evidence that the child was abused.

(c) The county agency shall submit a new CY-48 to ChildLine as required in subsection (a) when a final status determination is made under subsection (b).

(d) A supplemental child abuse report form shall be submitted to ChildLine on founded and indicated reports when additional case information is obtained, including

dates of birth, identity of the subjects, additional information about the nature of the abuse, or the case is presented before a court and there is a change in the status of the report.

**§ 3490.68. Retention of information on unfounded reports.**

(a) When a county agency determines that a report of suspected child abuse is unfounded but accepts the family for services, the agency shall maintain the records under Chapter 3130 (relating to administration of county children and youth social service programs).

(b) If the county agency has determined that a report is unfounded, the status of the report may not be changed subsequently to founded or indicated. If additional information surrounding the incident becomes available, the county agency shall file a new report with ChildLine.

**§ 3490.69. Reports not received within 60-calendar days.**

When the CY-48 form is not filed with ChildLine within 60-calendar days of receipt of the report by ChildLine, the report shall be unfounded.

**§ 3490.70. Expunction and amendment of report by the county agency.**

The county agency shall amend or expunge a record of child abuse upon notification from ChildLine. The county agency shall expunge all information in its possession in unfounded, founded and indicated reports of child abuse upon notification from ChildLine. The county agency shall notify those to whom it gave information to take similar action.

**§ 3490.71. Guardian ad litem and court designated advocate.**

The county agency shall cooperate with and provide information to a guardian ad litem appointed under section 6382 of the CPSL (relating to guardian ad litem for child in court proceedings) and the court designated advocate. When appropriate, because of the age or mental and emotional condition of the child, the guardian ad litem in addition to representing the best interests of the child shall also determine the wishes of the child concerning the proceedings and shall communicate this information to the court.

**§ 3490.72. (Reserved).**

**§ 3490.73. Petitioning the court.**

The county agency shall petition the court if one of the following applies:

(1) Placement or continued placement of a child is necessary.

(2) A subject of the report of suspected child abuse refuses to cooperate with the county agency in an investigation, and the county agency is unable to determine whether the child is at risk.

(3) The parents refuse services, and the county agency determines that services are in the best interests of the child.

**CHILD ABUSE BY AGENTS OF THE COUNTY AGENCY**

**§ 3490.81. Responsibilities of the Department and the county agency.**

(a) When the suspected abuse has been committed by an agent of the county agency, the regional staff shall investigate the report under section 6362 of the CPSL



(relating to responsibilities of county agency for child protective services) and this chapter. The regional staff may not do any of the following:

- (1) Take protective custody.
- (2) Petition the court.
- (3) Provide services.

(b) If a report is determined indicated or founded and the regional staff determines that services are necessary, the regional staff, the county agency in the county where the abuse occurred and the county agency with custody or supervision of the child, if different, shall plan for social and rehabilitative services for the child and perpetrator. The plan shall identify which county is responsible for case management.

(c) Regional staff shall conduct the investigation regardless of the relationship of the agent to the subject child.

**CONFIDENTIALITY**

**§ 3490.91. Persons to whom child abuse information shall be made available.**

(a) Reports, report summaries and other accompanying information obtained under the CPSL and this chapter in the possession of the Department and a county agency are confidential. Except for the subject of a report, persons who receive information under this section shall be advised that they are subject to the confidentiality provisions of the CPSL and this chapter, that they are required to insure the confidentiality and security of the information and that they are liable for civil and criminal penalties for releasing information to persons who are not permitted access to this information. This material shall only be released under the CPSL and this chapter and be made available only to the following:

(1) An authorized official of a county agency or of an agency of another state that performs protective services analogous to those services performed by county agencies or the Department in the course of the official's duties, multidisciplinary team members assigned to the case and authorized persons providing services by referral or under section 6364 of the CPSL (relating to purchasing services of other agencies). The name of the person who made the report or cooperated in the investigation may be released to county agencies in this Commonwealth and out-of-State agencies providing protective services provided they have a legitimate need to know this information to protect the child and the person requesting the information can assure the confidentiality of the identity of the persons who made the report or cooperated in the investigation.

(2) A physician examining or treating a child or the director of a hospital or medical facility treating a child, if the physician or the director of a hospital or medical facility suspects the child of being an abused child.

(3) A guardian ad litem and court designated advocate for the child.

(4) An authorized official or agent of the Department including the following:

- (i) The Secretary.
- (ii) Deputy Secretaries of the Department and designated staff, in cases involving alleged or actual abuse of children in facilities or programs under their jurisdiction.
- (iii) ChildLine staff.

(iv) Authorized officials or agents of the Department who are conducting a performance audit as authorized under section 6343 of the CPSL (relating to investigating performance of county agency) and this chapter.

(5) A court of competent jurisdiction under a court order or a court of common pleas upon written request from a judge in connection with any matter involving custody of a child.

(i) When the Department receives a written request under this paragraph, ChildLine will send to the court copies of the Report of Suspected Child Abuse (CY-47); the ChildLine Report of Suspected Child Abuse and Neglect For ChildLine Use Only (CY-47C); the Child Protective Service Investigation Report (CY-48); and the Child Protective Service Supplemental Report (CY-49) on file at ChildLine involving the subject child, the child's siblings and their parents.

(ii) If the court requests specific files or information that is not on file at ChildLine, ChildLine will notify the county agency administrator to provide the information directly to the court.

(6) A standing committee of the General Assembly, under section 6384 of the CPSL (relating to legislative oversight).

(7) The Attorney General.

(8) Federal auditors, if required for Federal financial participation in funding of agencies, but Federal auditors may not remove identifiable reports or copies of them from the Department or county agencies.

(9) Law enforcement officials of any jurisdiction inside or outside of this Commonwealth if the information is relevant in the course of investigating cases of:

(i) Homicide, sexual abuse or exploitation, or serious bodily injury perpetrated by persons whether or not related to the victim.

(ii) Suspected child abuse perpetrated by persons who are not family members.

(iii) Repeated physical injury to a child under circumstances which indicate that the child's health or welfare is harmed or threatened.

(iv) A missing child report.

(10) Law enforcement officials who shall immediately receive reports of suspected child abuse from the county agency, when the initial report or initial review by the county agency gives evidence that the alleged child abuse is one of the following:

(i) Homicide, sexual abuse or exploitation, or serious bodily injury perpetrated by persons whether or not related to the child.

(ii) Child abuse perpetrated by persons who are not family members.

(11) Designated county officials in reviewing the competence of the county agency or its employees under the CPSL and this chapter. Officials under this paragraph are limited to the following:

(i) The board of commissioners in counties other than counties of the first class.

(ii) The mayor of a city of the first class under the act of April 21, 1949 (P. L. 665, No. 155), known as the First Class City Home Rule Act.

(iii) An individual serving as a county chief executive as designated by a county home rule charter or optional

plan form of government under the act of April 13, 1972 (P. L. 184, No. 62), known as the Home Rule Charter and Optional Plans Law.

(12) A subject of the report upon written request.

(13) A person, agency or institution, upon written consent of all subjects of the report may receive a copy of the reports on file with the county agency and ChildLine.

(14) Individuals authorized by the Department to conduct studies of data, if the study does not contain the name or other information by which the subjects of reports may be identified.

(15) Required reporters of suspected child abuse whose access to information is limited to the following:

(i) The final status of the report following the investigation, whether it be indicated, founded or unfounded.

(ii) Services provided or arranged by the county agency to protect the child from further child abuse. This information may be released to the required reporter at any time after the report of suspected child abuse has been made.

(16) A prospective adoptive parent, approved by an adoption agency, when considering adopting an abused child in the custody of a county agency. The adoption agency and the county agency having custody of the child shall determine the scope and detail of information which shall be provided so that the prospective parent may make an informed decision to adopt.

(17) Members of a local or State child fatality review team authorized under sections 6340(a)(4) and 6343(b) of the CPSL (relating to release of information in confidential reports; and investigating performance of county agency), formally organized for the purpose of assisting in the investigation of child death or the development and promotion of strategies to prevent child death. The information shall be provided only through staff of the county agency or Department who are members of the team.

(b) Prospective child care service employe applicants, prospective adoptive and foster parents, prospective administrators and prospective operators of child care services, and any person seeking voluntary certification may request and receive information concerning whether there exists on file in the Statewide Central Register indicated or founded reports of child abuse naming the person as perpetrator of child abuse under section 6344 of the CPSL (relating to information relating to prospective child-care personnel).

(c) Information on file at the Statewide Central Register as a result of a request to amend or expunge a founded or indicated report of child abuse under §§ 3490.105 and 3490.105a (relating to request by the subject of a founded or indicated report for expunction or amendment of an abuse report when the report was received by ChildLine prior to July 1, 1995; and request by a perpetrator to amend or expunge an indicated report of child abuse received by ChildLine after June 30, 1995) may only be released to the Secretary or Secretary's designees in the course of their official duties and the Attorney General when conducting an audit under section 6345 of the CPSL (relating to audits by Attorney General).

(d) A person, including a law enforcement official, who willfully breaches the confidentiality or security of information that the person received under this subsection, in addition to other civil or criminal penalties provided by law, shall be denied access to any confidential child abuse information in the future.

### § 3490.92. Requests by and referrals to law enforcement officials.

(a) Requests for child abuse information by law enforcement officials under § 3490.91(a)(9) (relating to persons to whom child abuse information shall be made available) shall be made with the following requirements:

(1) Requests shall be in writing and signed by the law enforcement official.

(2) Requests shall indicate that the child abuse information is needed by the law enforcement official in the course of investigating a case of the following:

(i) Homicide, sexual abuse or exploitation, or serious bodily injury, perpetrated by persons whether or not related to the victim.

(ii) Child abuse perpetrated by persons who are not family members.

(iii) Repeated physical injury to a child under circumstances that indicate that a child's health or welfare is harmed or threatened.

(iv) A missing child report.

(3) The information shall include the names of the persons who made the report and who cooperated in the investigation when requested by the law enforcement official.

(b) Referrals to law enforcement officials required by § 3490.91(a)(10) shall be made with the following requirements:

(1) Referrals shall be made by the county agency to the District Attorney or other appropriate law enforcement official.

(2) Referrals shall be made if the initial report to or initial review by the county agency gives evidence that the alleged abuse perpetrated by persons whether or not related to the child is one of the following:

(i) Homicide.

(ii) Sexual abuse or exploitation.

(iii) Serious bodily injury.

(3) Referrals shall be made if the initial report to or initial review by the county agency gives evidence that the alleged child abuse is child abuse perpetrated by persons who are not family members.

(4) If during the course of investigating a report of suspected child abuse, the county agency obtains evidence which indicates that referral to law enforcement officials is appropriate, the county agency shall immediately refer the report to the law enforcement official.

(5) The county agency may not refer to law enforcement officials reports of suspected child abuse which do not meet the requirements of paragraphs (2) and (3).

(6) Reports shall be made verbally under policies and procedures developed in conjunction with the district attorney and other law enforcement officials.

(7) Reports shall be made in writing on the next work day when the report is made verbally or within 24 hours of when the county agency determines that the report meets the criteria for making a report to law enforcement officials. Written reports shall be made on forms developed by the Department.

(8) The county agency shall release the names of the person who made the report or cooperated in the investigation to law enforcement officials upon request.

(c) If the complaint of suspected abuse is determined to be one which cannot be investigated by the county agency because the person accused of the abuse is not a perpetrator, but does suggest the need for investigation, the county agency shall immediately transmit the information to the appropriate authorities.

(d) The county agency may not provide information to a law enforcement official under this section, unless the law enforcement official is known to or has exhibited proper identification to the county agency.

(e) Law enforcement officials shall treat all reporting sources and persons who cooperated in the investigation as confidential informants.

**§ 3490.93. Requests by designated county officials.**

Requests for child abuse information by designated county officials under § 3490.91(a)(11) (relating to persons to whom child abuse information shall be made available) shall be made under the following requirements:

(1) Requests shall be made in writing and addressed to the county administrator.

(2) Requests shall be signed by:

- (i) A majority of the county commissioners.
- (ii) The mayor of a city of the first class.
- (iii) The county chief executive.

(3) Requests shall indicate that the information is needed by the designated county officials as part of an investigation of the competence of a county agency or county agency employe.

(4) Requests shall identify the specific files needed.

(5) The county agency shall provide the requested information and inform the designated county officials that the information may not be released to anyone except those permitted access to this information under § 3490.91 and that they are subject to § 3490.102 (relating to criminal liability for breach of confidentiality).

**§ 3490.94. Release of the identity of a person who made a report of child abuse or cooperated in a subsequent investigation.**

(a) Except for the release of the identity of the persons who made a report of suspected child abuse or cooperated in the investigation under § 3490.91(a)(9) and (10) and 3490.92(a)(3) (relating to persons to whom child abuse information shall be made available; and requests by and referrals to law enforcement officials), the release of data that would identify the person who made a report of suspected child abuse or person who cooperated in a subsequent investigation is prohibited, unless the Secretary finds that the release will not be detrimental to the safety of the person.

(b) Prior to releasing information under subsection (a) to anyone other than a law enforcement official under subsection (a), the Secretary will notify the person whose identity would be released that the person has 30-calendar days to advise the Secretary why this anticipated release would be detrimental to the person's safety.

**§ 3490.95. Release of information to required reporters.**

The release of information by the county agency to required reporters under § 3490.91(a)(15) (relating to persons to whom child abuse information shall be made available) is subject to the following:

(1) The information released by the county agency shall concern the same child who was the subject of the report made by the required reporter.

(2) The required reporter shall request the information, either verbally or in writing.

(3) Before releasing the allowable information, the county agency shall verify the identity of the required reporter in one of the following ways:

(i) The county agency shall be able to recognize the voice of the required reporter when the request is made verbally by telephone.

(ii) If the county agency is not familiar with the required reporter and does not recognize the reporter's voice the county agency may verify the request of the required reporter by returning the telephone call to the reporter's place of employment.

(iii) If the county agency is unable to verify a telephone request for information from a required reporter under subparagraphs (i) and (ii), the county agency shall obtain a written request for information from the required reporter.

(4) The county agency shall release the information under § 3490.91(a)(15) when requested by a required reporter.

(5) The county agency may release the information under § 3490.91(a)(15), either verbally or in writing, to the required reporter whether or not a request for information was received.

(6) The county agency shall inform the required reporter of the reporter's obligation to protect the confidentiality of information released as required under sections 6339 and 6340 of the CPSL (relating to confidentiality of reports; and release of information in confidential reports).

(7) The county agency shall make an entry of the request made by the required reporter and the response given in the case record.

**GENERAL REQUIREMENTS FOR CHILD PROTECTIVE SERVICES**

**§ 3490.101. Sanctions.**

A staff member of the Department or county agency who willfully violates the CPSL and this chapter is subject to disciplinary action, including dismissal.

**§ 3490.102. Criminal liability for breach of confidentiality.**

A person who willfully releases or permits the release of data or information contained in the pending complaint file, the Statewide Central Register or the county agency records, to persons or agencies not permitted by this chapter to receive this information shall be guilty of a misdemeanor of the third degree. In addition, the person shall be denied access in the future to information that the person would otherwise be entitled to receive under the CPSL and this chapter.

**§ 3490.103. Nonabuse reports received by the county agency or other public agency from ChildLine.**

Public agencies, including county agencies, shall evaluate those referrals from ChildLine made under section 6334 of the CPSL (relating to disposition of complaints received) which have not been identified as reports of suspected child abuse. If, after the evaluation, the agency

has reason to suspect that child abuse occurred, the agency shall make a report of suspected abuse to ChildLine.

**§ 3490.104. Release of information to a subject of a report.**

(a) Upon written request to a county agency or ChildLine, a subject of a report may receive at any time a copy of the reports filed with the county agency and ChildLine. The identity of the person who made the report or a person who cooperated in a subsequent investigation may be released only under § 3490.94 (relating to release of the identity of a person who made a report of child abuse or cooperated in a subsequent investigation).

(b) Upon written request, a defendant in a criminal proceeding is entitled to the child abuse information in the possession of a county agency in accordance with applicable law. The information is limited to the county agency record from the date the report was made to the date the county agency determined the status of the report. The county agency shall send the requested information to the defendant and the district attorney. The information that is released to the defendant and the district attorney may not contain the identity of the persons who made the report or cooperated in the investigation.

**§ 3490.105. Request by the subject of a founded or indicated report for expunction or amendment of an abuse report, when the report was received by ChildLine prior to July 1, 1995.**

(a) A subject of an indicated or founded report may request in writing that the Secretary amend or expunge the report on the grounds that it is inaccurate or being maintained in a manner inconsistent with the CPSL and this chapter.

(b) The Secretary will decide whether to grant or deny a request made under subsection (a) within 30 days from the date the request is received. The Secretary will notify subjects of the report and the appropriate county agency of the decision by first-class mail.

**§ 3490.105a. Request by a perpetrator to amend or expunge an indicated report of child abuse received by ChildLine after June 30, 1995.**

(a) A perpetrator of an indicated report of child abuse may request the Secretary to amend or expunge the report on the grounds that it is inaccurate or is being maintained in a manner inconsistent with the CPSL and this chapter. The request shall be in writing and postmarked within 45-calendar days of the mailing date of the letter from ChildLine under §§ 3490.40 and 3490.40a (relating to notifications regarding indicated reports; and notifications regarding founded reports).

(b) The Secretary will decide within 30-calendar days whether or not to grant the request. The Secretary will notify the perpetrator, the county agency and other subjects in writing as follows:

(1) Except the subject child, all other subjects of the report when the decision is to grant the request.

(2) Only the perpetrator when the decision is to deny the request.

(c) The notification from the Secretary will be sent by first-class mail.

**§ 3490.106. Hearings and appeals proceedings for reports received by ChildLine prior to July 1, 1995.**

(a) A subject of the report and the appropriate county agency have the right to appeal the Secretary's decision to grant or deny a subject's request to amend or expunge an indicated or founded report by filing an appeal with the Secretary.

(b) Appeals shall be in writing to the Secretary and be postmarked within 45-calendar days from the date of the Secretary's notification letter to either grant or deny the request.

(c) If a subject or county agency files an appeal under § 3490.105 (relating to request by the subject of a founded or indicated report for expunction or amendment of an abuse report when the report was received by ChildLine prior to July 1, 1995), the subject or county agency has the right to a hearing before the Department's Bureau of Hearings and Appeals.

(d) Except as provided in subsection (e), hearings will be conducted under 2 Pa.C.S. §§ 501—508 and 701—704 (relating to the Administrative Agency Law) and 1 Pa. Code Part II (relating to General Rules of Administrative Practice and Procedures).

(e) Hearings will be scheduled and final administrative action taken in accordance with the time limits specified in § 275.4(b) and (e)(1), (3) and (5) (relating to procedures).

(f) The burden of proof in hearings held under this section is on the appropriate county agency.

(g) A court finding of fact of child abuse is presumptive evidence that the report was substantiated.

(h) Parties to a hearing held under this section have 30-calendar days from the date of the final order of the Bureau of Hearings and Appeals to request the Secretary to reconsider the decision or appeal the final order to the Commonwealth Court.

**§ 3490.106a. Hearings and appeals proceedings for indicated reports received by ChildLine after June 30, 1995.**

(a) A perpetrator may appeal the Secretary's decision to deny the request to expunge an indicated report by filing an appeal with the Secretary.

(b) The other subjects of the report and the county agency may appeal the Secretary's decision to grant the request to expunge the report.

(c) The request shall be made to the Secretary and postmarked within 45-calendar days of the date of the notification letter from the Secretary to either grant or deny the request to expunge the report.

(d) If an appeal is taken, there is a hearing before the Department's Bureau of Hearings and Appeals.

(e) Except as provided in subsection (f), hearings will be conducted under 2 Pa.C.S. §§ 501—508 and 701—704 (relating to the Administrative Agency Law) and 1 Pa. Code Part II (relating to General Rules of Administrative Practice and Procedure).

(f) Hearings will be scheduled and final administrative action taken in accordance with the time limits specified in § 275.4(b) and (e)(1), (3) and (5) (relating to procedures).

(g) The burden of proof in hearings held under this section is on the appropriate county agency.

(h) Parties to a hearing held under this section have 15-calendar days from the mailing date of the final order of the Bureau of Hearings and Appeals to request the Secretary to reconsider the decision or 30-calendar days to appeal the final order to the Commonwealth Court.

(i) An administrative appeal proceeding will be automatically stayed upon notice to the Department by any subject or the county agency that there is a pending criminal proceeding or a dependency or delinquency proceeding under the Juvenile Act including an appeal thereof, involving the same factual circumstances.

**§ 3490.107. Notification of Secretary's decision to amend or expunge a report of child abuse.**

The Secretary, after ordering a record to be amended or expunged, shall advise ChildLine of the decision.

**§ 3490.108. Cooperation of county agencies and law enforcement agencies.**

Consistent with this chapter, the county agencies and law enforcement agencies shall cooperate and coordinate, to the fullest extent possible, their efforts to respond to reports of suspected child abuse.

**§ 3490.109. Report from law enforcement agencies.**

The law enforcement agency shall, as soon as possible and without jeopardizing the criminal investigation or prosecution, advise the county agency as to whether a criminal investigation has been undertaken and the results of the investigation and of any criminal prosecution in cases of suspected child abuse. The county agency shall ensure that the information is referred to ChildLine in a timely manner.

**VERIFICATION OF THE EXISTENCE OF CHILD ABUSE AND STUDENT ABUSE RECORDS FOR CHILD CARE SERVICES**

**§ 3490.121. Definitions.**

The following words and terms, when used in this section and §§ 3490.122—3490.127 (relating to verification of the existence of child abuse and student abuse records for child care services) have the following meanings, unless the context clearly indicates otherwise:

*Administrator*—A person hired by or under contract with a legal entity to be responsible for the management and operation of a child care service.

*Applicant*—A person who will have direct contact with children in a child care service, who does one of the following:

- (i) Applies for gainful employment in a child care service, including an administrator, or other support personnel.
- (ii) Applies for employment with a contractor who is under contract with a child care facility or program.
- (iii) Is employed by a contractor seeking a contract with a child care facility or program.

*Child care service*—

(i) Child day care centers, group and family day care homes, foster homes, adoptive parents, boarding homes for children, juvenile detention center services or programs for delinquent or dependent children; mental health, mental retardation, early intervention and drug and alcohol services for children; and other child care services which are provided by or subject to approval, licensure, registration or certification by the Department

or a county social services agency or which are provided under a contract with the Department or a county social services agency.

(ii) The term does not include services or programs which may be offered by public and private schools, intermediate units or area vocational-technical schools.

*Child caretaker*—

(i) A person whether compensated or not who provides care for a child and who voluntarily solicits certification from the Department under section 6344 of the CPSL (relating to information relating to prospective child-care personnel).

(ii) The term includes a babysitter, scout leader or den parent.

*Direct contact with children*—Access to children by a paid employe of or person under contract with a child care service who has routine and unsupervised access to children in the course of carrying out the employe's responsibilities in a child care service.

*Legal entity*—Includes a society partnership, corporation or another governing authority legally responsible for the administration and operation of a child care service.

*Operator*—A person who provides a child care service but is not hired by or under contract with a legal entity.

*Permanent employe*—A child care worker who meets one of the following conditions:

- (i) Has met the requirement of § 3490.122 (relating to responsibilities of an applicant, prospective operator or legal entity of a child care service).
- (ii) Was employed prior to January 1, 1986, and was not required to submit the requests for clearances.

*Request for verification*—A request to the Statewide Central Register from an applicant, operator of a child care service, foster parent or adoptive parent or a child caretaker seeking voluntary certification to determine whether the applicant is named as a perpetrator in an indicated or founded report of child abuse.

**§ 3490.122. Responsibilities of an applicant, prospective operator or legal entity of a child care service.**

(a) An applicant or prospective operator of a child care service shall submit a request for verification on forms provided by the Department. The request for verification shall include a check or money order for the fee charged by the Department, payable to the Department of Public Welfare, which will not exceed \$10. Prospective workfare program participants are exempt from payment of the fee. To obtain a form for the clearance statement, an applicant may call the ChildLine verification unit at (717) 783-6211 and request a Pennsylvania Child Abuse History Clearance Form.

(b) A person who applies to the Department or the Department of Health to operate a child care service shall comply with procedures established by these Departments for documentation of compliance with the requirements for reports of child abuse and criminal record history information.

(c) An administrator, or other person responsible for hiring decisions, may not hire or contract with an applicant, nor may a prospective operator be issued a certificate of compliance or registration if the Department has verified that the applicant or prospective operator is named in the Statewide Central Register as the perpetra-

tor of a founded report of child abuse committed within 5 years or less prior to the request for verification.

(d) An administrator, or other person responsible for hiring decisions, may not hire or contract with an applicant, nor may a prospective operator be issued a certificate of compliance or registration if the applicant's criminal history record information dictates that the applicant or prospective operator has been convicted of a crime as specified in section 6344 of the CPSL (relating to information relating to prospective child-care personnel) or an equivalent out-of-State crime as determined by the Department.

(e) An administrator, or other person responsible for hiring decisions, may not hire or contract with an applicant, nor may a prospective operator be issued a certificate of compliance or registration if the applicant's report of criminal history record verification or the report of child abuse record information was obtained more than 1 year prior to the date of application.

(f) An applicant or prospective operator of a child care service located in this Commonwealth who is not a resident of this Commonwealth is required to obtain a report of criminal history record from the Federal Bureau of Investigation according to procedures established by the Department and on forms provided by ChildLine.

**§ 3490.123. Responsibilities of prospective adoptive parents, prospective foster parents, foster family care agencies and adoption investigators.**

(a) A prospective adoptive parent or a prospective foster parent shall submit a request for verification on forms provided by the Department. The request for verification shall include a check or money order for the fee charged by the Department, payable to the Department of Public Welfare, which will not exceed \$10.

(b) In the course of causing an investigation to be made under 23 Pa.C.S. § 2535(a) (relating to investigation), an agency or person designated by the court to conduct the investigation shall require prospective adoptive parents to submit the information in section 6344 of the CPSL (relating to information relating to prospective child-care personnel) for review under subsection (d).

(c) In the course of approving a prospective foster parent, a foster family care agency shall require a prospective foster parent to submit the information in section 6344 of the CPSL for review by the foster family care agency under subsection (d).

(d) A prospective adoptive parent or prospective foster parent may not be approved by a foster family care agency, an adoption agency, or a person designated by the court under 23 Pa.C.S. § 2535(a) when any of the following circumstances exist:

(1) The parent has been named as a perpetrator of a founded report of child abuse committed within 5 years or less prior to the request for verification.

(2) The parent has been convicted of a crime under section 6344 of the CPSL or an equivalent out-of-State crime as determined by the Department.

(3) The report of criminal history record information or the report of child abuse record information was obtained more than 1 year prior to the date of application to the agency for approval or 1 year prior to the date of commencement of the investigation under 23 Pa.C.S. § 2535(a).

(e) A prospective adoptive parent or prospective foster parent who is not a resident of this Commonwealth is

required to obtain a report of criminal history from the Federal Bureau of Investigation according to procedures established by the Department and on forms provided by ChildLine.

**§ 3490.124. Departmental procedures for replying to a request for verification.**

(a) Requests for verification received on forms provided by the Department with a check or money order payable to the Department of Public Welfare in the amount charged by the Department will be processed. Prospective workfare participants are exempt from payment of the fee. Others will be returned with instruction for resubmitting the request.

(b) The Department will advise the person seeking verification in writing whether or not he is named as a perpetrator of an indicated or founded report of child abuse or a school employe responsible for student abuse named in the Statewide Central Register. If the person is named as a perpetrator of an indicated or founded report of child abuse or a school employe responsible for student abuse, the response will include the following information:

(1) The number of indicated or founded reports of child abuse and student abuse in which the person is named.

(2) The date of the incidents of indicated or founded reports of child abuse and student abuse in which the person is named.

**§ 3490.125. Voluntary certification of child caretakers.**

(a) A child caretaker may request certification from the Department that the requirements of section 6344 of the CPSL (relating to information relating to prospective child-care personnel) have been met.

(b) A child caretaker requesting voluntary certification who is a resident of this Commonwealth shall obtain a report of criminal history from the Pennsylvania State Police and submit it to the Department with the request for verification on forms provided by the Department.

(c) A child caretaker requesting voluntary certification who is not a resident of this Commonwealth shall secure a report of criminal history from the Federal Bureau of Investigation under procedures established by the Department on properly prepared forms provided by ChildLine.

(d) The Department will reply to requests for voluntary certification by providing the following:

(1) A copy of the report of criminal history record information from the Pennsylvania State Police.

(2) A report of child abuse and student abuse history record information under § 3490.124 (relating to Departmental procedures for replying to a request for verification).

(e) A request for voluntary certification from the Department may be made no more frequently than every 2 years.

(f) The Department will process requests for voluntary certification it receives on the forms developed by the Department. The request shall include a check or money order payable to the Department of Public Welfare in the amount charged by the Department. Others will be returned with instructions for resubmitting the request.

**§ 3490.126. Sanctions.**

(a) An administrator, or other person responsible for employment decisions in a child care facility or program

who willfully fails to comply with section 6344 of the CPSL (relating to information relating to prospective child-care personnel) is subject to civil penalty not to exceed \$2,500.

(b) Information received by a legal entity, an administrator, the Department or the Department of Health under § 3490.124 (relating to Departmental procedures for replying to a request for verification) is confidential and the legal entity, administrator, the Department and the Department of Health are subject to § 3490.102 (relating to criminal liability for breach of confidentiality).

**§ 3490.127. Information relating to prospective child care personnel.**

(a) The administrator of a child care service may employ applicants on a provisional basis for a single period of employment pending the receipt of the required clearances in accordance with section 6344 of the CPSL (relating to information relating to prospective child-care personnel).

(b) The maximum period of employment allowed for a provisional employe is as follows:

(1) Thirty calendar days for an applicant residing in this Commonwealth.

(2) Ninety calendar days for an out-of-State applicant.

(c) The administrator may employ an applicant on a provisional basis if the administrator has no knowledge or information that would disqualify the applicant from employment in accordance with section 6344 of the CPSL (relating to information relating to prospective child-care personnel) and if the applicant has complied with each of the following:

(1) Mailed the requests for the required clearances to ChildLine, the State Police and the FBI, if applicable.

(2) Provided copies of these completed request forms for clearances to the administrator to retain as a condition of provisional employment.

(3) Sworn or affirmed in writing that the applicant was not disqualified from employment under section 6344 of the CPSL or an equivalent out-of-State crime.

(d) During the 30- or 90-day provisional period, the provisional employe may not be permitted to work alone with children and shall work within the vicinity of a permanent employe.

(e) If the provisional employe does not submit the required clearances within 30- or 90-calendar days of employment, whichever is applicable, the administrator shall do one of the following:

(1) Dismiss the provisional employe until the required clearances are received.

(2) Lay off or place the provisional employe on leave with or without pay until the clearances are received.

(3) Retain and reassign the provisional employe to a position that does not involve direct contact with children.

(f) A provisional employe shall be immediately dismissed from employment if he is disqualified from employment under section 6344 of the CPSL.

**VERIFICATION OF THE EXISTENCE OF CHILD ABUSE AND STUDENT ABUSE RECORDS FOR SCHOOL EMPLOYEES**

**§ 3490.131. Definitions.**

The following words and terms, when used in this section and §§ 3490.132—3490.137, have the following meanings, unless the context clearly indicates otherwise:

*Administrator*—

(i) The person responsible for the administration of a public or private school, intermediate unit or area vocational-technical school.

(ii) The term includes a person responsible for employment decisions in a school and an independent contractor.

*Applicant*—

(i) An individual who applies for a position as a school employe including a person applying to be a volunteer in charter or regional charter schools.

(ii) The term includes an individual who transfers from one position as a school employe to another position as a school employe.

*Clearance statement*—An official clearance statement from the Department on whether an applicant's name is on file in the Statewide Central Register as a perpetrator in an indicated or founded report of child abuse or an indicated or founded report of student abuse, or both.

*Direct contact with students*—Access to children by a school employe who has routine and unsupervised access to children in the course of carrying out the employe's responsibilities in a school.

*Independent contractor and the contractor's employes*—A person employed in a position on a contractual basis with a school who has direct contact with students.

*Position*—The job classification of a school employe as defined and determined by existing law, State regulation or the school board or governing authority including administrative and supervisory staff, teachers, paraprofessionals, support staff or others.

*School*—All schools including public and nonpublic schools as defined in the Public School Code of 1949 (24 P. S. §§ 1-101—27-2702) and private academic schools as defined in 22 Pa. Code Part II (relating to State Board of Private Academic Schools), as follows:

(i) *Public*—School districts, intermediate units, area vocational-technical schools, charter and regional charter schools.

(ii) *Registered*—Nonpublic (religiously affiliated schools).

(iii) *Licensed*—Private academic schools that are licensed by the Department of Education (includes residential facilities that hire their own staff to teach residents of the facility).

(iv) *Accredited*—Accredited by an accreditation association or organization.

(v) *State-owned*—Scotland School and Scranton School for the Deaf.

*School employe*—

(i) An individual employed in a position by a school.

(ii) The term includes independent contractors and their employes.

(iii) The term excludes individuals who have no direct contact with students.

*Substitute list*—A list, approved by the hiring authority of a school, containing the names of persons eligible to serve the school as substitute teachers or temporary replacements for other employes.

*Transfer*—A change from one position to another.

**§ 3490.132. Responsibilities of an administrator.**

(a) An administrator shall require each applicant to submit a clearance statement obtained from the Department within the immediately preceding year as to whether the applicant is named as the perpetrator of an indicated or founded report of child abuse or the individual responsible for an indicated or founded report of student abuse.

(b) The clearance statement under subsection (a) is not required for an applicant who meets the following conditions:

(1) Transfers from one position as a school employe to another position as a school employe of the same school district or of the same organization.

(2) Has, prior to the transfer, already obtained the official clearance statement under subsection (a).

(c) Except as provided in § 3490.134 (relating to information relating to prospective school employes), an administrator may not hire an applicant if the applicant is the perpetrator of a founded report of child abuse or the individual responsible for a founded report of student abuse.

(d) An administrator may not hire an applicant if the clearance statement is more than 1 year old as determined by the date on the clearance statement.

(e) School administrators shall, in their contracts with independent contractors and their employes who have direct contact with students, require contractors to include provisions for a clearance statement as required by this chapter.

(f) A clearance statement is required only prior to the initial hiring of a substitute and remains in effect as long as the substitute continues to be employed by the same school. When a substitute seeks to have his name added to another school's substitute list, the substitute shall provide a current clearance statement to the additional school. The fact that a substitute appears on one school's substitute list is not sufficient evidence to allow another school to add the substitute's name to its substitute list.

(g) The administrator shall make a copy of the clearance statement and place it in the employe's personnel record.

**§ 3490.133. Responsibilities of an applicant.**

(a) An applicant shall submit a request for a clearance statement to the Department on the form provided by the Department. The request shall include a check or money order payable to the Department of Public Welfare in the amount specified on the application. The fee may not exceed \$10.

(b) To obtain a form for the clearance statement, an applicant may call the ChildLine verification unit at (717) 783-6211 and request a Pennsylvania Child Abuse History Clearance Form.

(c) An applicant shall show the original clearance statement to the administrator and permit a copy to be made.

**§ 3490.134. Information relating to prospective school employes.**

(a) Section 3490.132 (relating to responsibilities of an administrator) does not apply to a person working in a school who meets the following conditions:

(1) Is under 21 years of age.

(2) Is participating in a job development or job training program.

(3) Is employed for not more than 90-calendar days.

(b) An administrator may employ an applicant on a provisional basis if the following apply:

(1) The applicant attests in writing by oath or affirmation that he has submitted a request for a clearance statement and is not disqualified under § 3490.132.

(2) The administrator has no knowledge of information which would disqualify the applicant under § 3490.132.

(c) The provisional period may not exceed:

(1) Thirty-calendar days for residents of this Commonwealth.

(2) Ninety-calendar days for residents of another state.

(d) An administrator may not hire an applicant on a provisional basis during a strike under the Public Employee Relations Act (43 P. S. §§ 1101.201—1101.2201).

(e) If the applicant does not submit the clearance statement within 30- or 90-calendar days, whichever is applicable, the administrator shall do one of the following:

(1) Dismiss the provisional employe until the required clearance statement is received.

(2) Lay off or place the provisional employe on leave with or without pay until the clearance statement is received.

(3) Retain and reassign the provisional employe to a position that does not involve direct contact with children.

(f) An administrator shall immediately dismiss a provisional employe if the employe is the perpetrator of a founded report of child abuse or the individual responsible for causing serious bodily injury to or sexually abusing or exploiting a student in a founded report of student abuse.

**§ 3490.135. Responsibilities of the Department.**

(a) Requests for clearance statements received on forms provided by the Department with a check or money order payable to the Department of Public Welfare in the amount charged by the Department will be processed. The Department will return the forms that are not completed properly with instructions for resubmitting the request.

(b) The Department will advise the person seeking a clearance statement in writing whether or not he is named as a perpetrator of an indicated or founded report of child abuse or a school employe responsible for student abuse named in the Statewide Central Register. If the person is named as a perpetrator of an indicated or founded report of child abuse or a school employe responsible for student abuse, the response will include the following information:

(1) The number of indicated or founded reports of child abuse and student abuse in which the person is named.

(2) The date of the incidents of indicated or founded reports of child abuse and student abuse in which the person is named.

(c) The Department will comply with the request for an official clearance statement within 14 days of receipt of the request by the Department.



**§ 3490.136. Sanctions.**

An administrator who willfully violates section 6355 of the CPSL (relating to requirement) shall be subject to an administrative penalty of \$2,500. An action under section 6355 of the CPSL is governed by 2 Pa.C.S. §§ 501—508 and 701—704 (relating to Administrative Agency law).

**Subchapter B. ABUSE OF STUDENTS IN SCHOOL**  
**INTRODUCTION**

- Sec.
- 3490.141. Applicability.
- 3490.142. Purpose.
- 3490.143. Definitions.

**SCHOOL RESPONSIBILITIES**

- 3490.151. Required reporting.
- 3490.152. Responsibilities of administrators and certain school employes.
- 3490.153. Information provided to the district attorney and law enforcement officials.
- 3490.154. Release of information by a school employe including an administrator.

**LAW ENFORCEMENT RESPONSIBILITIES**

- 3490.161. Responsibilities of law enforcement officials.

**COUNTY RESPONSIBILITIES**

- 3490.171. Receipt and investigation of reports of suspected student abuse.
- 3490.172. Coordination of an investigation.
- 3490.173. Notifications by the county agency.
- 3490.174. Services for students.
- 3490.175. Expunction and amendment of reports of student abuse by the county agency.

**DEPARTMENT RESPONSIBILITIES**

- 3490.181. Agents of the county agency.
- 3490.182. ChildLine files.

**GENERAL REQUIREMENTS FOR STUDENT ABUSE**

- 3490.191. Request by a school employe to amend or expunge an indicated report of student abuse.
- 3490.192. Request for a hearing by a school employe for indicated reports of student abuse.
- 3490.193. Other provisions.

**INTRODUCTION**

**§ 3490.141. Applicability.**

This subchapter applies to the Department, county agencies, law enforcement officials and schools.

**§ 3490.142. Purpose.**

The purpose of this subchapter is to implement the provisions of the CPSL relating to student abuse.

**§ 3490.143. Definitions.**

In addition to the definitions in § 3490.4 (relating to definitions), the following words and terms, when used this section and §§ 3490.141, 3490.142, 3490.151—3490.154, 3490.161, 3490.171—3490.175, 3490.181, 3490.182 and 3490.191—3490.193, have the following meanings, unless the context clearly indicates otherwise:

*Administrator*—The person responsible for the administration of a public or private school, intermediate unit or area vocational-technical school. The term includes an independent contractor.

*Founded report for a school employe*—A report of student abuse if there is any judicial adjudication based on a finding that the student suffered serious bodily injury or sexual abuse or exploitation, including the entry of a plea of guilty or nolo contendere or a finding of guilt to a criminal charge involving the same factual circumstances involved in the allegations of student abuse.

*Indicated report for a school employe*—A report of student abuse if an investigation by the county agency

determines that substantial evidence of serious bodily injury or sexual abuse or exploitation exists based on one or more of the following:

- (i) Available medical evidence.
- (ii) The county agency's investigation.

(iii) An admission of causing serious bodily injury to a student or sexually abusing or exploiting a student by the school employe.

*School*—All schools including public and nonpublic schools as defined in the Public School Code of 1949 (24 P. S. §§ 1-101—27-2702) and private academic schools as defined in 22 Pa. Code Part II (relating to State Board of Private Academic Schools) as follows:

(i) *Public*—School districts, intermediate units, area vocational-technical schools, charter and regional charter school.

(ii) *Registered*—Nonpublic (religiously affiliated schools).

(iii) *Licensed*—Private academic schools that are licensed by the Department of Education (including residential facilities that hire their own staff to teach residents of the facility).

(iv) *Accredited*—Accredited by an accreditation association or organization.

(v) *State-owned*—Scotland School and Scranton School for the Deaf.

*School employe*—A person employed by or under contract with a school.

*Student*—An individual enrolled in a school who is under 18 years of age.

*Student abuse*—One or more of the following:

- (i) Serious bodily injury.
- (ii) Sexual abuse or exploitation when committed by a school employe against a student.

*Subjects of a report*—The child, parent, guardian or other person responsible for the welfare of the child and the school employe named in a report of suspected student abuse.

*Unfounded report for a school employe*—A report of student abuse unless the report is a founded report for a school employe or an indicated report for a school employe.

**SCHOOL RESPONSIBILITIES**

**§ 3490.151. Required reporting.**

(a) A school employe who has reasonable cause to suspect, on the basis of professional or other training and experience, that a student coming before the school employe in the employe's professional or official capacity is a victim of serious bodily injury or sexual abuse or exploitation by another school employe, shall immediately notify the administrator of the alleged abuse or injury.

(b) When a school employe learns of suspected student abuse from another person, the school employe shall notify the administrator of the alleged student abuse if the school employe has reasonable cause to suspect, on the basis of professional or other training and experience, that the student is a victim of serious bodily injury or sexual abuse or exploitation by a school employe.

(c) If an administrator learns of suspected student abuse from another person, the administrator shall make a report of suspected student abuse as required by this subchapter.

**§ 3490.152. Responsibilities of administrators and school employes.**

(a) An administrator, and in certain cases a school employe, as stated in subsection (b), shall report immediately to law enforcement officials and the appropriate district attorney a report of abuse or injury alleged to have been committed by a school employe against a student. If an administrator is the school employe who suspects injury or abuse, the administrator shall make a report to law enforcement officials and the appropriate district attorney.

(b) If the administrator is the employe suspected of abusing the student, the school employe who suspects the abuse shall immediately report that information to law enforcement officials and the appropriate district attorney.

(c) The verbal report shall be followed up with a written report on a form provided by the Department. Call (717) 783-1964 to obtain a copy of the form—Report of Suspected Student Abuse (CY 47-D).

**§ 3490.153. Information provided to the district attorney and law enforcement officials.**

The school official shall provide the following information to the district attorney and law enforcement officials on a form provided by the Department:

- (1) The name, age and home address of the student.
- (2) The name and address of the school.
- (3) The name and address of the student's parents or guardians.
- (4) The name and address of the administrator or school employe who made the report.
- (5) The name, work and home address of the school employe suspected of abusing the student.
- (6) The nature of the alleged offense.
- (7) Specific comments or observations that are directly related to the alleged incident and the individuals involved.

**§ 3490.154. Release of information by a school employe including an administrator.**

(a) Information in a student abuse report is confidential and may only be released by a school employe who made a report of suspected student abuse to:

- (1) The administrator.
- (2) A law enforcement official in the course of investigating the allegation of suspected student abuse.

(b) This section applies to an administrator when the administrator made the report of suspected student abuse.

**LAW ENFORCEMENT RESPONSIBILITIES**

**§ 3490.161. Responsibilities of law enforcement officials.**

(a) Law enforcement officials, in cooperation with the district attorney, shall accept the report of suspected student abuse for investigation and determine what criminal charges, if any, will be filed against the school employe.

(b) Law enforcement officials shall notify the county agency in the county where the alleged student abuse occurred when law enforcement officials have reasonable cause to suspect, on the basis of their initial review, that there is evidence of suspected student abuse.

**COUNTY RESPONSIBILITIES**

**§ 3490.171. Receipt and investigation of reports of suspected student abuse.**

(a) The county agency is the sole civil agency responsible for investigating reports of suspected student abuse. The investigation shall be conducted by a protective service worker.

(b) When a county agency receives a report of suspected student abuse, it shall immediately notify ChildLine of the receipt of the report and begin an investigation as soon as possible. The oral report shall include the following information:

- (1) The name and address of the student and the student's parent or guardian.
- (2) Where the suspected abuse or injury occurred.
- (3) The age and sex of the student.
- (4) The nature and extent of the suspected abuse or injury.
- (5) The name and home address of the school employe alleged to have committed the abuse or injury.
- (6) The relationship of the student to the school employe alleged to have committed the abuse or injury.
- (7) The source of the report to the county agency.

(8) The actions taken by the county agency, law enforcement officials, parents, guardians, school officials or other persons, including the taking of photographs, medical tests and X-rays.

(c) At a minimum, the county agency shall have a face-to-face interview with the child, any witnesses to the abuse and the school employe suspected of causing the abuse, unless the employe refuses to be interviewed.

(d) The county agency's investigation shall be completed within 60-calendar days of when the report was received by ChildLine. The county agency shall submit a Child Protective Service Investigation Report form to ChildLine with a status determination of founded, indicated, unfounded or pending criminal court action. If the Child Protective Service Investigation Report form is not received within 60-calendar days from the date the report was received by the county agency, the report shall be considered unfounded. Prior to expunging the report, ChildLine shall verify with the county agency that the report was not completed within 60-calendar days.

(e) If the investigation cannot be completed within 60-calendar days because an arrest has been made or there is criminal court action pending, the county agency shall send the Child Protective Services Investigation Report with a status determination of one of the following:

- (1) Pending criminal court action.
- (2) Indicated, when there is substantial evidence that the child was abused.

(f) The county agency shall submit a new Child Protective Service Investigation Report form to ChildLine as required in subsection (e) when a final status determination is made.

**§ 3490.172. Coordination of an investigation.**

(a) The county agency and law enforcement officials shall coordinate their investigations to the fullest extent possible. Interviews with the student shall be conducted jointly. However, law enforcement officials may interview the school employe prior to the county agency contacting the employe.

(b) The joint interview with the student may be waived on an individual case-by-case basis if both the county agency and law enforcement official agree that it is in the best interest of the student.

(c) The county agency and law enforcement officials shall keep each other informed of their respective investigations.

(d) The county agency and law enforcement officials shall avoid taking or arranging to have taken duplicate photographs, medical tests or X-rays of a student, whenever possible.

(e) The county agency may rely on a factual investigation of substantially the same allegation by a law enforcement official to support the agency's finding. This reliance does not relieve the county agency from conducting its own investigation.

**§ 3490.173. Notifications by the county agency.**

(a) Prior to the initial interview with a subject of a report of student abuse, the county agency shall verbally notify the subject of the existence of the report, the allegations of student abuse and the school employe's rights regarding amendment and expunction.

(b) Within 72 hours of the initial interview, the county agency shall notify the subject in writing of the following:

- (1) The existence of the report.
- (2) The allegations of student abuse.
- (3) The school employe's rights regarding amendment and expunction.
- (4) The right to obtain a copy of the report from ChildLine or the county agency.
- (5) The fact that unfounded reports are expunged within 120-calendar days of receipt of the report by ChildLine.

(6) The effect that a founded or indicated report of child abuse or student abuse has on a school employe responsible for student abuse seeking employment in a child care service or as a school employe.

(c) The written notice required by subsection (b) may be reasonably delayed if notification is likely to:

- (1) Threaten the safety of the victim, the safety of another subject or the safety of an investigating county agency worker.
- (2) Cause the school employe to abscond or to significantly interfere with the conduct of a criminal investigation.

(d) The written notice shall be given to all subjects before the status determination is submitted to ChildLine.

(e) The county agency shall notify, in writing, the district attorney and the law enforcement officials who conducted the investigation and the school administrator or employe, or both, who made the report to the district attorney and law enforcement officials of the status of the report when the county agency notifies ChildLine of the status of the report.

**§ 3490.174. Services for students.**

The county agency shall assist the student who was abused and the student's parents in locating services for the student, if necessary.

**§ 3490.175. Expunction and amendment of reports of student abuse by the county agency.**

The county agency shall amend a record of student abuse upon notification from ChildLine. The county agency shall expunge all information in its possession in unfounded, indicated and founded reports of student abuse upon notification from ChildLine.

**DEPARTMENTAL RESPONSIBILITIES**

**§ 3490.181. Agents of the county agency.**

The regional staff of the Department shall investigate reports of suspected student abuse when the person alleged to have abused the student is an agent of the county agency.

**§ 3490.182. ChildLine files.**

ChildLine will establish three files for reports of student abuse as follows:

(1) The pending complaint file for reports under investigation which shall contain the following information:

- (i) The name and address of the student and the student's parents or guardians.
- (ii) Where the suspected abuse or injury occurred.
- (iii) The age and sex of the student.
- (iv) The nature and extent of the suspected student abuse or injury.
- (v) The name and home address of the school employe alleged to have committed the abuse or injury.
- (vi) The relationship of the school employe alleged to have committed the abuse to the student who was allegedly abused by the school employe.
- (vii) The source of the report (the name of the law enforcement official) to the county agency.
- (viii) The actions taken by the county agency, law enforcement officials, parents, guardians, school officials or other persons, including the taking of photographs, medical tests and X-rays.

(2) The Statewide Central Register of indicated and founded reports for school employes which shall contain the following information:

- (i) The name, Social Security Number, date of birth and sex of the subjects of the report.
- (ii) The home address of the subjects of the report.
- (iii) The date and the nature and extent of the abuse.
- (iv) The county in which the student abuse occurred.
- (v) The factors contributing to the abuse.
- (vi) The relationship of the school employe who abused the student to the student.
- (vii) The source of the report the name of the school administrator/school employe who made the report to a law enforcement official and the district attorney.
- (viii) Whether the report is a founded or indicated report.

(ix) Information obtained by the Department in relation to a school employe's request to release, amend or expunge information retained by the Department or the county agency.

(x) The progress of any administrative or civil legal proceedings brought on the basis of the report.

(xi) Whether a criminal investigation was done and the result of the investigation and of any criminal prosecution.

(3) The file of unfounded reports awaiting expunction which contains the same information that is in the Statewide Central Register.

#### GENERAL REQUIREMENTS FOR STUDENT ABUSE

##### § 3490.191. Request from a school employe to amend or expunge an indicated report of student abuse.

(a) The school employe responsible for the student abuse may request the Secretary to amend or expunge an indicated report for a school employe on the grounds that it is inaccurate or it is being maintained in a manner inconsistent with this chapter. The written request shall be postmarked within 45-calendar days of the mailing date of the letter from the Statewide Central Register notifying the employe of the indicated status.

(b) The Secretary will decide whether to grant or deny a request made under subsection (a) within 30-calendar days from the date the request is received. The Secretary will notify all subjects of the report and the appropriate county agency of the decision by first-class mail.

##### § 3490.192. Request for a hearing from a school employe for indicated reports of student abuse.

(a) The school employe responsible for the student abuse has the right to appeal the Secretary's decision to deny the request to amend or expunge an indicated report by filing an appeal with the Secretary.

(b) Any other subject of a report and the county agency have the right to appeal the Secretary's decision to grant the request.

(c) Appeals shall be in writing to the Secretary's designee, the Bureau of Hearings and Appeals, and be postmarked within 45-calendar days from the mailing date of the Secretary's notification letter.

(d) If an appeal is filed, a hearing shall be held before the Department's Bureau of Hearings and Appeals.

(e) Except as provided in subsection (f), hearings will be conducted under 2 Pa.C.S. §§ 501—508 and 701—704 (relating to the Administrative Agency Law) and 1 Pa. Code Part II (relating to General Rules of Administrative Practice and Procedure).

(f) Hearings will be scheduled and final administrative action taken in accordance with the time limits specified in § 275.4(b) and (e)(1), (3) and (5) (relating to procedures).

(g) The burden of proof in hearings held under this section is on the appropriate county agency.

(h) Parties to a hearing held under this section have 15-calendar days from the date of the final order of the Bureau of Hearings and Appeals to request the Secretary to reconsider the decision or 30-calendar days to appeal the final order to the Commonwealth Court.

(i) Any administrative appeal proceeding will be automatically stayed upon notice to the Department by any subject or the county agency that there is a pending criminal proceeding or a dependency or delinquency proceeding under the Juvenile Act, including an appeal thereof, involving the same factual circumstances.

##### § 3490.193. Other provisions.

The following sections apply to reports of student abuse to the extent that they are applicable:

- (1) Section 3490.31 (relating to receipt of reports).
- (2) Section 3490.35 (relating to Statewide Central Register).
- (3) Section 3490.36 (relating to providing information to the county agency).
- (4) Section 3490.37 (relating to release of information: Statewide Central Register, pending complaint file and file of unfounded reports).
- (5) Section 3490.38 (relating to authorized studies of child abuse data).
- (6) Section 3490.40 (relating to notifications regarding indicated reports).
- (7) Section 3490.40a (relating to notifications regarding founded reports).
- (8) Section 3490.41 (relating to determination of time).
- (9) Section 3490.42 (relating to performance audit and reviews).
- (10) Section 3490.54 (relating to independent investigation of reports).
- (11) Section 3490.91 (relating to persons to whom child abuse information shall be made available).
- (12) Section 3490.93 (relating to requests by designated county officials).
- (13) Section 3490.94 (relating to the release of the identity of a person who made a report of child abuse or cooperated in a subsequent investigation).
- (14) Section 3490.104 (relating to release of information to a subject of a report).

#### Subchapter C. GENERAL PROTECTIVE SERVICES

##### INTRODUCTION

- Sec.
- 3490.201—3490.210. (Reserved).
- 3490.221. Applicability.
- 3490.222. Purposes.
- 3490.223. Definitions.

##### COUNTY RESPONSIBILITIES

- 3490.231. Functions of the county agency for general protective services.
- 3490.232. Receiving reports and assessing the need for services.
- 3490.233. Protective custody.
- 3490.234. Notifications.
- 3490.235. Services available through the county agency for children in need of general protective services.
- 3490.236. General protective services records.

##### GENERAL REQUIREMENTS FOR GENERAL PROTECTIVE SERVICES

- 3490.241. Appeals with respect to general protective services.
- 3490.242. Confidentiality.

##### §§ 3490.201—3490.210. (Reserved).

##### INTRODUCTION

##### § 3490.221. Applicability.

This subchapter applies to the Department and county children and youth social service agencies.

##### § 3490.222. Purposes.

The purpose of this subchapter are to:

- (1) Protect the safety, rights and welfare of children so that they have an opportunity for healthy growth and development.

(2) Assist parents in recognizing and remedying conditions harmful to their children and in fulfilling their parental duties in a manner that does not put their children at risk.

**§ 3490.223. Definitions.**

In addition to the definitions in § 3490.4 (relating to definitions), the following words and terms, when used in this subchapter, have the following meanings, unless the context clearly indicates otherwise:

*Assessment*—An evaluation by the county agency to determine whether or not a child is in need of general protective services.

*Custodial parent*—The parent responsible for the day-to-day care and supervision of the child.

*General protective services*—Services to prevent the potential for harm to a child who meets one of the following conditions:

(i) Is without proper parental care or control, subsistence, education as required by law, or other care or control necessary for his physical, mental, or emotional health, or morals.

(ii) Has been placed for care or adoption in violation of law.

(iii) Has been abandoned by his parents, guardian or other custodian.

(iv) Is without a parent, guardian or legal custodian.

(v) Is habitually and without justification truant from school while subject to compulsory school attendance.

(vi) Has committed a specific act of habitual disobedience of the reasonable and lawful commands of his parent, guardian or other custodian and who is ungovernable and found to be in need of care, treatment or supervision.

(vii) Is under 10 years of age and has committed a delinquent act.

(viii) Has been formerly adjudicated dependent under section 6341 of the Juvenile Act (relating to adjudication), and is under the jurisdiction of the court, subject to its conditions or placements and who commits an act which is defined as ungovernable in subparagraph (vi).

(ix) Has been referred under section 6323 of the Juvenile Act (relating to informal adjustment), and who commits an act which is defined as ungovernable in subparagraph (vi).

*Parent*—A biological parent, adoptive parent, legal guardian or primary person responsible for a child.

*Potential for harm*—

(i) Likely, if permitted to continue, to have a detrimental effect on the child's health, development or functioning.

(ii) The term does not include imminent risk as defined in the definition of "child abuse" in § 3490.4.

*Primary person who is responsible for the care of a child*—A person who provides or arranges ongoing care and supervision to a child in lieu of parental care and supervision.

*Report*—A verbal or written statement to the county agency from someone alleging that a child is in need of general protective services.

**COUNTY RESPONSIBILITIES**

**§ 3490.231. Functions of the county agency for general protective services.**

Each county agency is responsible for administering a program of general protective services to children that is consistent with the agency's objectives to:

(1) Keep children safely in their own homes, whenever possible.

(2) Prevent abuse, neglect and exploitation of children.

(3) Overcome problems that could result in dependency.

(4) Provide temporary, substitute placement in the home of a relative, other individual who has a significant relationship with the child or the child's family, a foster family home or residential child-care facility for children in need of this care.

(5) Reunite children safely with their families, whenever possible, when children are in temporary, substitute placement.

(6) Provide a permanent, legally assured family for children in temporary, substitute care who cannot be returned to their own home.

(7) Provide services and care ordered by the court for children who have been adjudicated dependent.

**§ 3490.232. Receiving reports and assessing the need for services.**

(a) The county agency shall be the sole civil agency responsible for receiving and assessing all reports alleging a need for general protective services. Nothing in this subchapter limits section 6304 or 6334 of the Juvenile Act (relating to powers and duties of probation officers; and petition).

(b) The county agency shall provide 24-hours-per-day/7-day-per-week telephone access to receive reports alleging a need for general protective services.

(c) The county agency shall see the child immediately if emergency protective custody has been taken, is needed, or if it cannot be determined from the report whether or not emergency protective custody is needed. Otherwise, the county agency shall prioritize the response time for an assessment to assure that children who are most at risk receive an assessment first.

(d) The county agency shall use a State-approved risk assessment process for general protective services as required by § 3490.321 (relating to establishment of standards for a risk assessment process) to:

(1) Aid in its assessment of whether to accept the family for services.

(2) Insure that its assessment is comprehensive.

(3) Help determine the need for general protective services.

(4) Assist in the development of the family service plan.

(e) The county agency shall complete an assessment within 60-calendar days to determine whether or not the child and family should be accepted for general protective services, be referred to another agency for services or close the case.

(f) The county agency shall see the child and visit the child's home during the assessment period. The home visits shall occur as often as necessary to complete the assessment and insure the safety of the child. There shall be a least one home visit.

(g) The county agency shall interview the child, if age appropriate, and the parents or the primary person who is responsible for the care of the child. The county agency shall also conduct interviews with those persons who are known to have or may reasonably be expected to have information that would be helpful to the county agency in determining whether or not the child is in need of general protective services.

(h) The county agency may make unannounced home visits.

(i) The county agency shall provide or arrange appropriate services to assure the safety of the child during the assessment period.

(j) The county agency shall initiate the appropriate court proceedings and assist the court during all stages of the court proceedings if the county agency determines that general protective services are in the best interest of a child and if an offer of an assessment, a home visit or services is refused by the parent.

**§ 3490.233. Protective custody.**

(a) A child alleged to be in need of general protective services may be taken into protective custody under §§ 3490.15—3490.17 and 3490.57.

(b) The director of a hospital or other medical facility or a person specifically designated in writing by the director, or a physician examining or treating a child may take a child into protective custody if it is immediately necessary to protect the child.

**§ 3490.234. Notifications.**

(a) The county agency shall notify the parent of the receipt of the report alleging the need for general protective services and that the county agency will do an assessment to determine the need for general protective services. The notification shall be made verbally at the time of the initial interview.

(b) The county agency shall provide written notice to the parents and the primary person who is responsible for the care of the child of the county agency's decision to accept or not accept the family for general protective services within 7-calendar days of making the decision. If the county agency accepts the family for services, it shall include the following information in the notice:

(1) The reasons why the county agency accepted the family for services.

(2) The right of the custodial parent or the primary person responsible for the care of the child to appeal the county agency's decision that the child is in need of general protective services.

(3) The request for an appeal shall be received by the county agency within 45-calendar days of the mailing date of the written notice in subsection (b).

(4) How to appeal the county agency's decision that the child is in need of general protective services.

(5) The written appeal request shall specify the reasons why the child is not in need of general protective services.

**§ 3490.235. Services available through the county agency for children in need of general protective services.**

(a) The county agency shall provide, arrange or otherwise make available the same services for children in need of general protective services as for abused children under § 3490.60 (relating to services available through the county agency).

(b) The county agency shall develop a family service plan as required by § 3130.61 (relating to family service plans) for each family accepted for general protective services.

(c) The county agency shall monitor the provision of services and evaluate the effectiveness of the services provided under the family service plan under § 3130.63 (relating to review of family service plans). The county agency worker shall visit the family in performing the case management responsibilities as required by § 3130.63 as often as necessary for management of the service provision at least every 180-calendar days.

(d) The county agency may purchase and use the services of any appropriate public or private agency under Chapter 3130 (relating to the administration of county children and youth social service programs).

(e) The county agency supervisor shall review each report alleging a need for general protective services which is being assessed on a regular and ongoing basis to assure that the level of services are consistent with the level of risk to the child, to determine the safety of the child and the progress made toward reaching a determination on the need for protective services. The supervisor shall maintain a log of these reviews which at a minimum shall include an entry at 10-calendar day intervals during the assessment period.

(f) When a case has been accepted for service and a family service plan has been developed under Chapter 3130, the county agency supervisor shall, within 10-calendar days of the completion of the family service plan, review the plan to assure that the level of activity, in person contacts with the child, oversight, supervision and services for the child and family which are contained in the plan, are consistent with the level of risk determined by the county agency for the case. Documentation of this review shall be in the case record.

(g) When a case has been accepted for services, the county agency shall monitor the safety of the child and assure that contacts are made with the child, parents and service providers. The contacts may occur either directly by a county agency worker or through purchase of service, by phone or in person but face-to-face contacts with the parent and the child shall occur as often as necessary for the protection of the child but at least as often as:

(1) Once a week until the case is no longer designated as high risk by the county agency, if the child remains in or returns to the home in which the need for general protective services was established and the county agency has determined a high level of risk exists for the case.

(2) Once a month for 6 months or case closure when the child is either:

(i) Placed out of the home or setting in which the need for general protective services was established.

(ii) No longer determined to be at a high risk by the county agency.

(h) A periodic assessment of the risk of harm to the child shall be conducted as required by the State-approved risk assessment process.

(i) Except when ordered by the court in a proceeding brought under the Juvenile Act, a county agency is not required to duplicate services which are the statutory responsibility of any other agency.

(j) The county agency shall aid the child and the family in obtaining benefits and services for which they may qualify under Federal, State and local programs.

(k) The family service plan shall contain a provision that requires the parents advise the county agency, within 24 hours, when the child or family move from one residence to another.

**§ 3490.236. General protective services records.**

(a) Records for reports that are accepted for general protective services shall be maintained under § 3130.43 (relating to family case records). In addition to the information required by § 3130.43, the records shall contain the following information:

- (1) The nature of each report for general protective services.
- (2) The date and source of the report.
- (3) The names and addresses of the persons interviewed in conducting the assessment of each report.
- (4) The services provided by the county agency during the assessment of the report.
- (5) How the level of services provided are consistent with the level of risk to the child.
- (b) Records for reports that are not accepted for service shall be maintained for 5 years following the receipt of the latest report alleging the need for general protective services. The following information shall be maintained:
  - (1) The name and address of the children.
  - (2) The names and addresses of the parents.
  - (3) The names and addresses of the primary persons who are responsible for the care of the child.
  - (4) The allegations of the need for general protective services.
  - (5) The date and source of the report.
  - (6) The names and addresses of the persons interviewed in conducting the assessment.
  - (7) The services provided by the county agency during the assessment.
  - (8) Referral to other community agencies.
  - (9) A summary of the assessment and reasons for not accepting the family for general protective services.

**GENERAL REQUIREMENTS FOR GENERAL PROTECTIVE SERVICES**

**§ 3490.241. Appeals with respect to general protective services.**

- (a) When a county agency accepts a case for services, the custodial parents or the primary persons who are responsible for the care of the child may appeal that decision.
- (b) The county agency shall establish policies and procedures for handling these appeals. The policies and procedures shall be in the agency's manual as required by § 3130.21 (relating to responsibilities of county executive officers).
- (c) An appeal from the custodial parent or the primary persons who are responsible for the care of the child shall be received by the county agency within 45-calendar days of the date of the letter from the county agency notifying the person of the agency's decision to accept the child and family for services. The written appeal request shall be made to the county agency administrator and specify the reasons why the child is not in need of general protective services.

(d) The county agency shall review the request and issue a written decision to the person who made the request within 45-calendar days of the receipt of the appeal. If the agency denies the request, the person who made the request shall be advised in writing of his right to a hearing before the Department's Bureau of Hearings and Appeals and that the request shall be made within 45-calendar days of the date of the letter from the county agency notifying the person of the agency's decision denying the request.

(e) If a hearing is requested, the Bureau of Hearings and Appeals will schedule a hearing under Article IV of the Public Welfare Code (62 P. S. §§ 401—493), and applicable Department regulations. The burden of proof in the hearing shall be on the county agency. The Department will assist the county agency as necessary.

(f) The Department is authorized and empowered to make any appropriate order regarding records to make them accurate or consistent with this chapter.

(g) Neither the county administrator nor the director of the Bureau of Hearings and Appeals may issue a ruling modifying the term of a service plan which has been specifically approved or ordered by a court of competent jurisdiction.

(h) Action by the custodial parent or the primary person who is responsible for the care of the child under this section does not preclude the custodial parent or the primary person who is responsible for the care of the child the right to exercise other appeals available through Department regulations or the courts.

**§ 3490.242. Confidentiality.**

Information obtained by the county agency or Department in connection with general protective services may only be released as follows:

- (1) Under § 3130.44 (relating to confidentiality of family case records).
- (2) To another county agency.
- (3) To an official of an agency of another state that performs general protective services analogous to those services performed by county agencies or the Department in the course of the official's duties.

**Subchapter D. GENERAL REQUIREMENTS FOR CHILD PROTECTIVE SERVICES AND GENERAL PROTECTIVE SERVICES**

**INTRODUCTION**

- Sec.
- 3490.301. Applicability.
- 3490.302. Purpose.
- 3490.303. Definitions.

**STAFF ORIENTATION, TRAINING AND CERTIFICATION REQUIREMENTS**

- 3490.311. Establishment of a staff development process.
- 3490.312. Training program requirements for direct service workers.
- 3490.313. Direct service worker certification requirements for supervisors who supervise direct service workers.
- 3490.314. Training and certification requirements for supervisors who supervise direct service workers.

**RISK ASSESSMENT**

- 3490.321. Standards for risk assessment.
- 3490.322. County agency compliance with risk assessment standards.

**ANNUAL REPORT**

- 3490.331. Annual report on required activities.

**STAFF RATIOS**

- 3490.341. Staff-to-family ratios.

**FAILURE TO COOPERATE**

3490.351. Willful failure to cooperate.

**STANDARDS FOR STAFF**

3490.361. Requirements for agencies providing protective services.

3490.362. Licensure requirements for persons providing services arranged or provided by the county agency.

**ATTORNEY FOR THE COUNTY AGENCY**

3490.371. Availability of an attorney for the county agency.

**LAW ENFORCEMENT OFFICIALS**

3490.381. Law enforcement assistance.

**ANNUAL PLAN**

3490.391. County agency plan.

**TRANSFER OF CASES**

3490.401. Intercounty transfer of cases.

**INTRODUCTION****§ 3490.301. Applicability.**

This subchapter applies to county agencies and other agencies and persons who provide services to abused and neglected children.

**§ 3490.302. Purpose.**

The purpose of this subchapter is to consolidate regulations that apply to both child protective services and general protective services.

**§ 3490.303. Definitions.**

In addition to the definitions in § 3490.4 (relating to definitions), the following words and terms, when used in this subchapter, have the following meanings, unless the context clearly indicates otherwise:

*CORE*—Training in foundation level skills which are needed by all direct service workers in county agencies to provide services to abused and neglected children and their families.

*Risk assessment*—A Department-approved systematic process that assesses a child's need for protection or services based on the risk of harm to the child.

*Training program*—The Pennsylvania Child Welfare Competency-Based Training and Certification Program.

**STAFF ORIENTATION, TRAINING AND CERTIFICATION REQUIREMENTS****§ 3490.311. Establishment of a staff development process.**

(a) In fulfillment of the requirements of section 6383 of the CPSL (relating to education and training), the Department will implement an initial and ongoing training program for direct service workers and supervisors in county agencies.

(b) To implement the training program, the Department will establish a steering committee cochaired by a representative from the Department and a representative from the Pennsylvania Children and Youth Administrators, Inc.

(c) The steering committee shall provide recommendations to the Department for the establishment and implementation of policies and procedures relating to staff orientation, training and certification as required by the CPSL and this chapter and provide recommendations for overall staff development designed to improve the competency of the direct service workers and supervisors in county agencies.

(d) The steering committee shall include among its functions the evaluation of program effectiveness tested against measurable outcomes.

**§ 3490.312. Training program requirements for direct service workers.**

(a) The county agency shall establish and implement policies for orientation of direct service workers.

(b) The county agency shall establish and implement written policies on the assignment of cases to new staff and staff reassigned as direct service workers, including the criteria used to determine when a worker is prepared to assume responsibility for a full caseload.

(c) The county agency shall implement the supervisors' orientation, training and resource manual. A county agency may implement its own process or manual provided it addresses the objectives of the manual provided through the training program and is approved by the Department.

(d) The Department, with consultation from its steering committee, will establish standards, a process and a program for county agencies relating to the initial and ongoing certification of direct service workers including the following requirements:

(1) Direct service workers include the persons providing direct services to children and families and case management functions on a full-time or part-time basis.

(2) Direct service workers hired on or after July 1, 1996, shall be certified under the established standards within 18 months of their date of employment.

(3) Direct service workers who are not in a permanent employment status as of July 1, 1996, shall be certified by December 31, 1997.

(4) Permanent direct service workers hired prior to July 1, 1996, are certified.

(5) Direct service workers hired after June 30, 1996, who are in the process of achieving initial certification may be assigned a caseload, up to the caseworker-to-family ratio of the county agency, based on the worker's ability to handle job duties as determined by the written policy of the county agency.

(6) Initial certification of direct service workers shall include the following components:

(i) A minimum of 120 hours of CORE training.

(A) The content of CORE training shall be determined by the Department in consultation with the steering committee.

(B) The content of CORE training shall be subject to periodic review by the Department and the steering committee for continued relevancy.

(C) An overview of CORE training shall be communicated by the Department to the county agencies and direct service workers through a Departmental bulletin.

(D) Upon request by a county agency and approval by the Department, a county agency may provide the CORE training developed by the training program to its direct service workers.

(E) The county agency shall maintain a record of CORE training completed for certification in the employee's personnel file.

(ii) A decision by the employing county agency that the worker is certified.

(A) The decision shall be based on an assessment of the worker's ability to apply the principles, concepts and content of CORE training, the supervisors' orientation, training and resource manual or its equivalent and other



learning opportunities to on-the-job situations. The assessment shall conclude with a decision of whether or not the worker is certified.

(B) The assessment shall be in writing and reviewed with the employe. The employe shall be given a copy of the assessment. A copy of the assessment shall be maintained in the employe's personnel file.

(7) The county agency shall determine the county agency's training year.

(8) Ongoing certification of direct service workers, shall include the following:

(i) Documentation of completion of a minimum of 20 hours of training annually. For direct service workers who complete the CORE training during the county agency's training year, the county agency shall prorate the number of required training hours that a direct service worker shall take in the county agency's training year schedule.

(A) Training content shall be based on the annual administration of an assessment of individual training needs and the development of an individual training plan.

(B) Ongoing training, as identified in the individual training plan, may be obtained through the training program, provided by a county agency or obtained through another provider.

(ii) Courses from an accredited school of social work which are successfully completed by a direct service worker shall be acceptable in meeting the ongoing certification requirements.

(iii) The county agency shall maintain a record of training required for ongoing certification, including the needs assessment, training plan and courses attended in the employe's personnel file.

(iv) The date of initial certification for grandfathered workers is June 30, 1996.

(9) The county agency shall provide its direct service workers the opportunity to obtain initial and ongoing certification status.

(10) The county agency may not allow an employe who fails to achieve or maintain certified status to perform direct service duties.

**§ 3490.313. Direct service worker certification requirements for supervisors who supervise direct service workers.**

(a) Supervisors who supervise direct service workers shall be certified as a direct service worker.

(1) Supervisors with permanent status on June 30, 1996, and who supervise direct service workers are grandfathered as certified direct service workers.

(2) Supervisors hired, transferred or promoted after June 30, 1996, who are not certified, shall meet the certification requirements in the training program requirements for direct service workers within 12 months of employment or transfer.

(b) Supervisors who supervise direct service workers who fail to meet the requirement of subsection (a) may not be permitted by the county agency to supervise direct service workers.

**§ 3490.314. Training and certification requirements for supervisors who supervise direct service workers.**

Persons employed, hired, transferred or promoted to supervise direct service workers on or after October 1,

1998, shall complete a supervisor's training program approved by the Department in consultation with the steering committee.

**RISK ASSESSMENT**

**§ 3490.321. Standards for risk assessment.**

(a) The standards established for risk assessment shall include the following:

(1) A statement of purpose for the process.

(2) The core set of factors against which risk shall be assessed.

(3) The application of the process, including the points at which the process shall be applied and the periodicity of application.

(4) The recordkeeping requirements.

(5) The process for State approval.

(b) The Department and counties will review the implementation of the risk assessment process on an ongoing basis to ensure that the standards established are consistent with good practice and the results of research.

(c) The county agency shall implement the State-approved risk assessment model developed by the Department in consultation with the Risk Assessment Task Force.

(d) The county agency shall apply the State-approved risk assessment process established under this section in performing the duties under Subchapters A and C (relating to child protective services; and general protective services).

(e) The factors which shall be assessed by the county agency include the following:

(1) The characteristics of the environment in which the child abuse occurred including the history of prior abuse and neglect.

(2) The characteristics of the parent, caregiver, household member, primary person responsible for the welfare of a child and perpetrator including history of drug and alcohol abuse.

(3) The characteristics of the family including the history of family violence.

(f) The county agency shall rate each factor in subsection (e) and shall provide documentation in the record to support the identified level of risk and to assure the child's safety.

(1) Each factor shall be rated using one of the following designations:

(i) No risk.

(ii) Low risk.

(iii) Moderate risk.

(iv) High risk.

(2) If a county agency is unable to assess the risk of a specific factor listed in subsection (e), the county agency shall indicate the reasons in the record.

(g) At the time of the report of suspected child abuse or allegations of children in need of general protective services, the county agency shall make an initial determination of the risk to the child.

(1) The county agency need not complete the risk assessment process if after one contact with the family the report is determined to be without any merit.

(2) The county agency shall document evidence which supports this finding in the record.

(h) Periodic assessments of risk shall be completed by the county agency as follows:

(1) At the conclusion of the intake investigation which may not exceed 60-calendar days.

(2) Every 6 months in conjunction with the family service plan or judicial review unless one of the following applies:

(i) The risk to the child remains low or no risk.

(ii) The child has been placed out of the home for more than 6 months and there are no other children in the home.

(3) Thirty-calendar days before and after the child is returned to the family home unless one of the following applies:

(i) The risk to the child remains low or no risk.

(ii) The child's return home was not anticipated by the county agency. A risk assessment for these cases shall be completed within 2 weeks of the child's return to the home.

(4) Thirty-calendar days prior to case closure.

(i) The county agency shall conduct a risk assessment as often as necessary to assure the child's safety.

(j) The county agency shall assess the safety and risk of the child when the circumstances change within the child's environment at times other than required under this section.

**§ 3490.322. County agency compliance with risk assessment standards.**

(a) Each county agency shall implement a State-approved risk assessment process in performance of its duties under sections 6362 and 6375 of the CPSL (relating to responsibilities of county agency for child protective services; and county agency requirements for general protective services) and this chapter.

(b) Each county agency shall implement the State-approved risk assessment process approved by the Department on July 1, 1997.

(c) The county agency shall implement its risk assessment process in a way which supports its overall decision making process for, and approach to, protective services.

(d) The county agency in developing and implementing the family service plan and placement amendment as required by Chapter 3130 (relating to administration of county children and youth social service programs) shall assure that the level of activity, in person contacts with the child, oversight, supervision and services for the child and family are consistent with the level of risk as determined by the county agency.

**ANNUAL REPORT**

**§ 3490.331. Annual report on required activities.**

(a) The Department will report annually to the Governor and General Assembly on the activities of this chapter, including the operations of the Statewide Central Register and the protective services provided by the county agencies. The report shall contain a statistical analysis of the following:

(1) The reports of suspected child abuse received by the Department.

(2) The reports of suspected student abuse received by the Department.

(3) The results of requests for child care clearances received by the Department.

(4) The costs to implement the law.

(5) An evaluation of services offered in response to the CPSL.

(6) The protective service referrals received and accepted by county agencies.

(7) The children over whom the county agencies maintain continuing supervision.

(8) The protective service cases closed by county agencies.

(9) The services provided to children and their families.

(10) Recommendations for legislative changes and the estimated increase or decrease in cost.

(b) The data required in subsection (a)(6)—(9) shall be submitted by the county agencies through the Children and Youth Quarterly Aggregate Reporting System on form CY-28 until the Department has implemented the child specific Adoption and Foster Care Analysis and Reporting System which will include information on protective services.

**STAFF RATIOS**

**§ 3490.341. Staff-to-family ratios.**

A county agency shall have sufficient, qualified staff and be organized to perform the functions required by the CPSL and this chapter. Staff-to-family ratios for protective service workers shall be in accordance with §§ 3130.32 and 3140.17 (relating to staffing requirements; and review of county plans and budgets).

**FAILURE TO COOPERATE**

**§ 3490.351. Willful failure to cooperate.**

An agency, school district or facility, or a person acting on behalf of an agency, school district or facility, that violates this chapter by willfully failing to cooperate with the Department or a county agency when investigating a report of suspected child abuse, suspected student abuse or suspected neglect commits a summary offense for a first violation and a misdemeanor of the third degree for subsequent violations under section 6346 of the CPSL (relating to cooperation of other agencies).

**STANDARDS FOR STAFF**

**§ 3490.361. Requirements for agencies providing protective services.**

The county agency shall arrange for or provide protective services for children and their families only through agencies that comply with §§ 3130.21, 3130.39 and 3130.40 (relating to responsibilities of county executive officers; services and facilities which may be used; and delivery of services through other service providers).

**§ 3490.362. Licensure requirements for persons providing services arranged or provided by the county agency.**

The county agency shall arrange for or provide services from persons who are not affiliated with an agency under § 3490.361 (relating to requirements for agencies providing protective services) only if the person possesses a valid license issued by the Department of State, if the profession is subject to mandatory licensure.

**ATTORNEY FOR THE COUNTY AGENCY**

**§ 3490.371. Availability of an attorney for the county agency.**

The county agency shall retain or ensure the availability of an attorney for consultation with and representation of the county agency in fulfilling its responsibilities under the CPSL and this chapter.

**LAW ENFORCEMENT OFFICIALS**

**§ 3490.381. Law enforcement assistance.**

A county agency staff member may request a law enforcement officer to be present at any time during the course of fulfilling the county agency staff person's responsibilities under the CPSL and this chapter without violating the confidentiality provisions of the CPSL or this chapter when the worker fears for his own safety or the safety of anyone else involved.

**ANNUAL PLAN**

**§ 3490.391. County agency plan.**

The county agency shall comply with Chapter 3140 (relating to planning and financial reimbursement requirements for county children and youth social service programs) regarding the development and submission of a plan for the provision of protective services required by the CPSL and this chapter.

**TRANSFER OF CASES**

**§ 3490.401. Intercounty transfer of cases.**

(a) County agencies shall share that information which will assist them in protecting children.

(b) When a report of suspected child abuse is under investigation, a report is being assessed to determine the need for general protective services or when a case has been accepted for protective services and the family moves to another county, and the address is known, the county agency shall:

(1) Immediately telephone the receiving county agency and tell them:

- (i) The name and address of the child and parents.
- (ii) The reason for agency involvement.
- (iii) The status of the case.
- (iv) The services that were being provided.
- (v) The level of risk assigned to the case.

(vi) Other information that would assist the receiving agency.

(2) Within 24 hours of the phone call, send a fax to the receiving agency to confirm the referral. The faxed information shall contain:

- (i) The name and address of the child and parents.
- (ii) The level of risk assigned to the case.
- (iii) The status of the case.

(c) The receiving agency shall accept the referral and determine what services are necessary to protect the child from abuse or neglect.

(d) When the case is a high risk case, the receiving county agency shall reassess the risk of abuse or neglect to the child and see the child within 24 hours of receiving the telephone referral. The county agency worker shall see the child at the child's new address.

(e) The receiving agency shall notify the referring agency of the status of the referral upon completing the investigation or assessment.

(f) Regardless of whether or not the address of the child and family is known, within 72 hours of the telephone referral, the referring agency shall fax or send by overnight mail to the receiving agency the following:

- (1) The family demographics.
- (2) The current family service plan and placement amendment.
- (3) The current risk assessment matrix and summary.
- (4) Court petitions and court orders.
- (5) A social summary, when available.
- (6) A copy of the CY-48 and other relevant ChildLine forms.
- (7) Other information that would assist the receiving agency in providing services to the child and parents.

(g) When a report of suspected child abuse or neglect is under investigation or assessment or when a case has been accepted for protective services and the family moves to another county, and the county where the child has moved to is known but not the street address, the referring county agency shall telephone the receiving county and give it the names and dates of birth of the child and parents.

(h) The referring and receiving agency shall make reasonable efforts to locate the family, including as appropriate, based on the age of the child and other circumstances, by contacting the following:

- (1) Post office of the last known address.
- (2) School.
- (3) Health professionals and health agencies.
- (4) Domestic relations office.
- (5) Parent locator services.
- (6) Law enforcement official.
- (7) County assistance office.
- (8) Known relatives.
- (9) Known neighbors.

(i) The referring and receiving county shall document their efforts to locate the child and family.

(j) The receiving county shall notify the referring county:

- (1) Within 10 days of locating the child and family, when found.
- (2) When the county has exhausted all reasonable efforts to locate the family.

[Pa.B. Doc. No. 99-1082. Filed for public inspection July 2, 1999, 9:00 a.m.]